

Overview

Waterborne climate systems

Optimal indoor climate with demand-controlled and energy efficient products.

Swegon

T 0320 - 28 61 81 | www.aerhaan-klimaattechnik.nl

Als het om lucht gaat.

AUERHAAN
KLIMAATTECHNIK

Flexible, low energy and low maintenance with Swegon's climate systems!

There are many reasons why you should choose water, our natural life source, as the cooling or heating medium in indoor climate systems. Water is able to carry more energy than air and in this way provides a more efficient system requiring less space. In addition to low installation and operating costs, water is also a good alternative from an environmental perspective.

No fan

With Swegon's waterborne indoor climate systems, there are no fans in the room, which means minimal sound, minimal maintenance and minimal energy consumption!

Maximum comfort

Preferably, an indoor climate system should not be noticeable. Besides low sound level, Swegon's waterborne systems have a well-designed appearance and capacity to supply air without draughts. They all have the prerequisites for neither being heard, seen nor felt. To put it briefly: Good climate systems that offer a comfortable indoor climate without disturbing the occupants. This is what we call a high degree of comfort!

Flexibility

When the operations in a building change, the airflow requirements might become different. This should not require having to replace the indoor climate system and no expensive investments should be necessary. The adjustable air distribution pattern and adjustable airflow along all sides enable you to simply modify the products to meet the new ventilation requirements. Swegon's adjustable indoor climate systems offer you assured capability for meeting future needs.

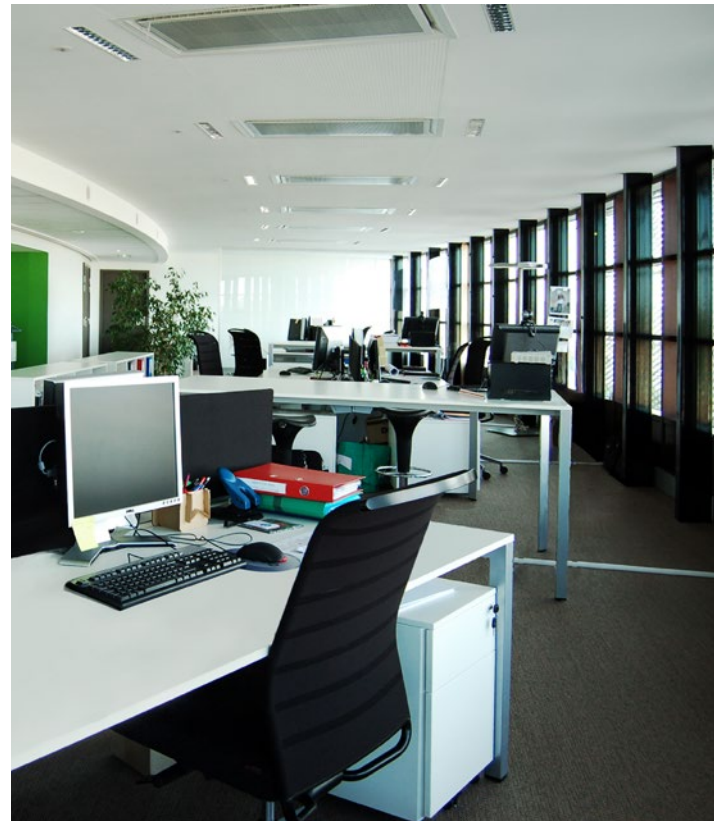

PARASOL is a ground-breaking comfort module with 4-way air discharge. The technique offers very high capacity and great flexibility.



The PRIMO perimeter wall indoor climate system offer customized casings with integrated conduits for electric and data cables.

Maximum comfort

Quiet, draught-free and aesthetically attractive!

Individual regulation of temperature

Check the indoor climate at room level!

No fan

No maintenance and no energy consumption!

No filter

No reduction in performance and no maintenance!

No drainage

No maintenance!

Ventilation, cooling and heating

Everything within the same unit!

High flexibility

Easy to adapt to the activities conducted in the premises!

Innovations with value added

Adjustable air distribution pattern

The risk of draught is avoided with Swegon's ADC (Anti Draught Control). This innovation offers great diffuser location flexibility and flexibility for future changes.

A number of ADC sections are fitted on each side of the unit. Each section is easily adjustable for capability to control the distribution pattern of the discharged air. This avoids the risk of draughts.

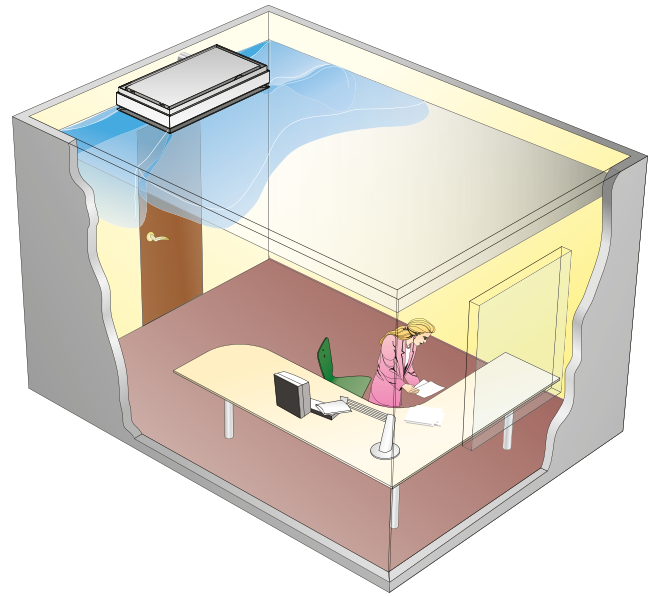
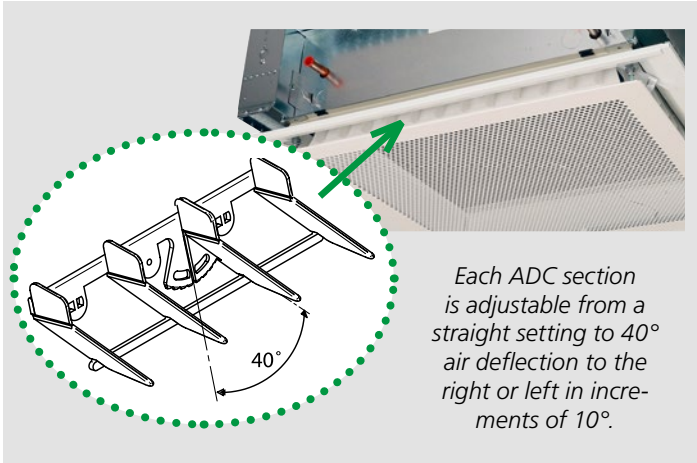

All four sides of the PARASOL comfort module can be individually adjusted both in terms of distribution pattern and airflow. This offers great module location flexibility and simplicity in making future changes. The example above shows location at the rear edge.

Induction provides high capacity

The induction principle offers very high cooling/heating capacity. The primary air is forced through nozzles. This creates negative pressure that draws (induces) room air that circulates through the water coil where it is cooled or heated as required. The circulated air mixes with the supply air and is discharged out into the room.

Example: PARASOL 1200
Cooling capacity, water: 685 W
Degree of induction: 3,75

Air distribution:
95 l/s (340 m³/h)
16,9°C

Primary air:
20 l/s (70 m³/h)
15°C

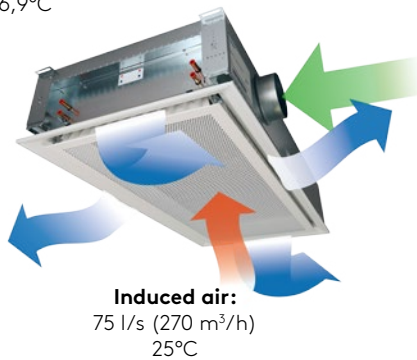

www.eurovent-certification.com
www.certiflash.com

Adjustable airflow

Swegon's Variflow built-in flow regulation system also offers immense flexibility in the location of air diffusers and for future changes. It is very simple to regulate the airflow by moving an air distribution strip over nozzles of different size.

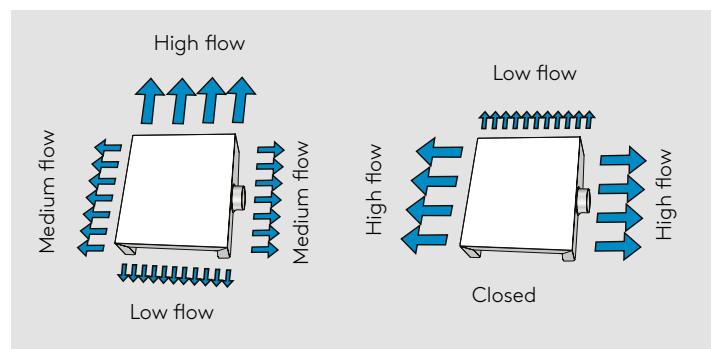

Examples of various flow settings that can be set in the PARASOL

PARASOL

Ground-breaking comfort module with high capacity and flexibility



PARASOL is a ground-breaking comfort module that combines climate beam efficiency with air diffuser flexibility.

The PARASOL modules can cool, heat and ventilate. They are designed for installation in false ceilings or as freely suspended modules (PARASOL EX). The face plate of the unit is available with various perforation patterns; other patterns are available to special order.

Both the airflow rate and the air distribution pattern can be regulated section-by-section along all four sides for optimal comfort. This offers enormous freedom when selecting beam locations without having to consider problems with draughts. If the operations in a building change, the PARASOL can be simply adjusted so that the comfort will be maximum, based on the new ventilation requirements.

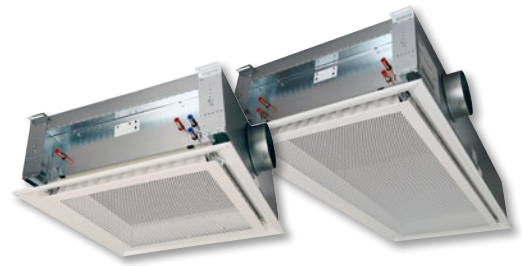

PARASOL with 4-way adjustable airflow and adjustable distribution pattern

PARASOL EX variant for suspended installation or surface mounting on suspended ceilings



Optimum comfort

Swegon's engineering solution makes it possible to control the air distribution pattern at site in each direction. The airflow rate can also be individually controlled in each direction.

High capacity

The Parasol modules can cool a room, yet use up to 50% less ceiling surface than ordinary climate beams do.

Modular design

Compact modular units in two sizes simplify the installation work.

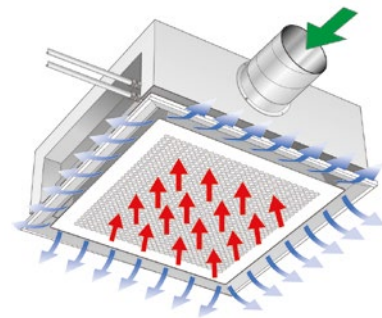

The basic function for cooling

➔
Primary air

➔
Circulation air

➔
Supply air

ADAPT Parasol, PARASOL VAV

Energy saving demand-controlled comfort modules

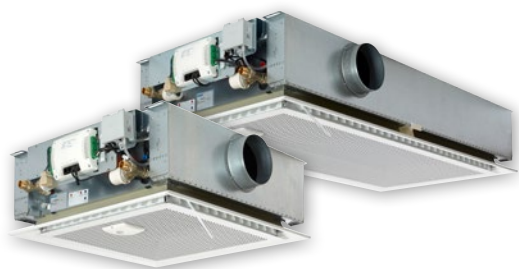
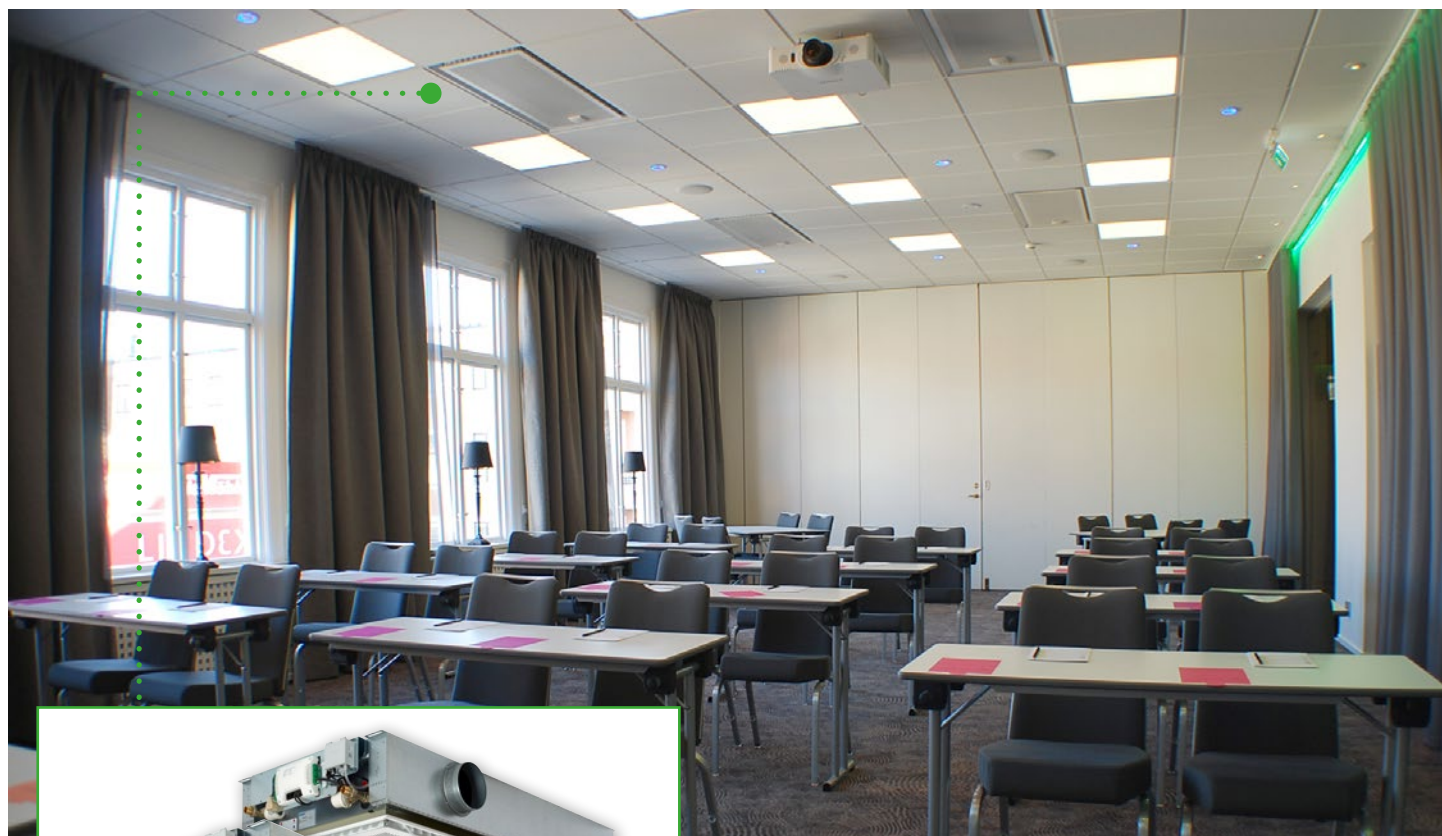

ADAPT Parasol

Slave

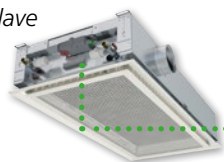

Slave

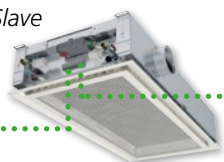

Master

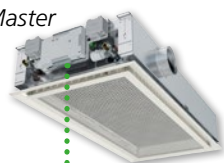

Slave

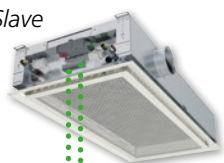

PARASOL VAV with one master and three slave units

Demand-controlled ventilation involves ventilating and conditioning the air in a room precisely to meet our needs - no more and no less. The potential for savings is substantial, especially in premises where there is considerable variation between low and high load conditions in rooms and during times when there are few or no occupants - which is the case in many premises. Offices, for example, often have a degree of occupancy below 50 %!

ADAPT Parasol combines the best of both worlds - demand-controlled ventilation with all its potential for savings combined with the power and performance of the comfort module for air conditioning the room. All this packaged in a compact unit that is easy to install and which has a future-proof design. The products and system can be easily adapted to new conditions brought about by refurbishing, moving walls or different kinds of refurbishment.

PARASOL VAV is a price-effective solution for demand controlled ventilation in rooms where numerous products are required and the need of adaptation to new conditions is low.



Optimum demand-controlled comfort

ADAPT Parasol and PARASOL VAV can demand-control the air in a room either as an individual product or as part of a system for demand-controlled ventilation.

High capacity

ADAPT Parasol and PARASOL VAV can cool a room, yet use up to 50% less ceiling surface than ordinary climate beams do.

Modular design

Compact modular units in two sizes simplify the installation work.

Climate beams with high comfort and flexibility

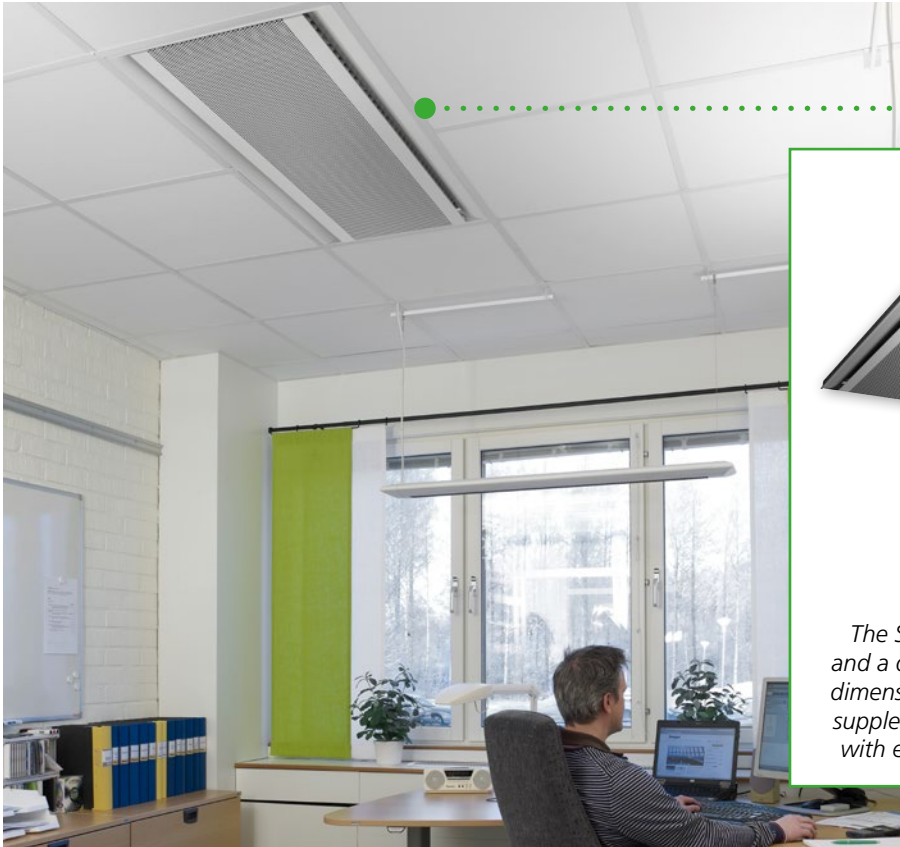

The Swegon PACIFIC is a new active climate beam with high capacity. It is composed of modules designed for meeting all conceivable requirements and for fitting all types of false ceiling.

The Swegon PACIFIC can cool, heat and ventilate. Both the airflow rate and the air distribution pattern can be regulated section-by-section along the long sides for the best possible comfort.

This offers enormous freedom when selecting beam locations without having to consider problems with draughts. If the operations in a building change, the PACIFIC can be simply adjusted to provide maximum comfort, based on the new ventilation requirements.

Optimum comfort

Swegon's engineering solution makes it possible to control the air distribution pattern at site section-by-section along each long side. The airflow rate can also be individually controlled for each long side.

High capacity

The PACIFIC has been developed for generating high cooling and heating capacity without comfort problems.

Flexibility

With high built-in flexibility, the climate beams are designed to meet today's needs as well as those of tomorrow. Customised modules are available for integration into most ceiling systems on the market.

The Swegon PACIFIC consists of a capacity module and a design module. The design module can be easily folded down. It is possible to order a design module having greater length in order to obtain e.g. sufficient inspection space for access to pipe couplings and possible dampers.

The size of the air connection can be selected to meet requirements. Connection in series is possible and calculation of the number of units and duct dimensions is carried out in the ProSelect computer program.

A standard Pacific can also be equipped with an additional module SA/EA, which is a built-in supply and extract air module.

The SA/EA module can also be supplemented with various types of accessory packages to provide different functionality.

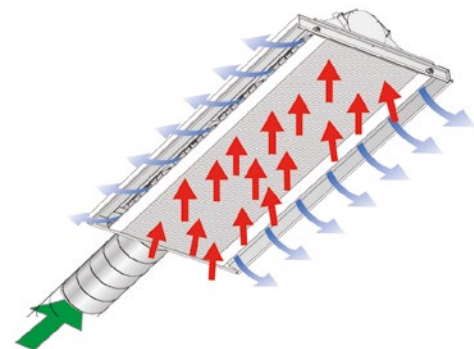

The basic function for cooling



PARAGON, PARAGON Wall

Comfort module for hotel rooms, hospital wards and office rooms



The PARAGON is a compact, comfort module for cooling, heating and ventilating e.g. hotel rooms and hospital wards where the unit is installed in the bulkhead by the entrance. PARAGON Wall is a variant for e.g. office rooms where the unit can be installed above the false ceiling of the corridor and with only a grille inside the room.

With the technique used, patent pending, the cooling and heating capacity are optimised, while the height is kept to the absolute minimum.

PARAGON is designed for Plug-and-Play installation. All necessary items of control equipment are included as standard. All the connections are easily accessible from the rear of the unit.

The PARAGON contains no moving parts and has no fan of its own. The primary air is distributed from a central air handling unit, which means very low audible sound level in the room.

PARAGON and PARAGON Wall are now available as high capacity variants where a CCO valve (Compact Change Over) is used to utilise the whole coil for both cooling and heating.

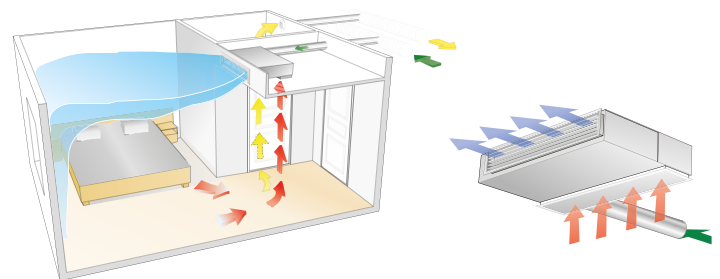
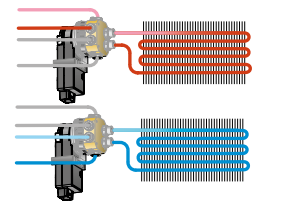

The basic function for cooling, PARAGON

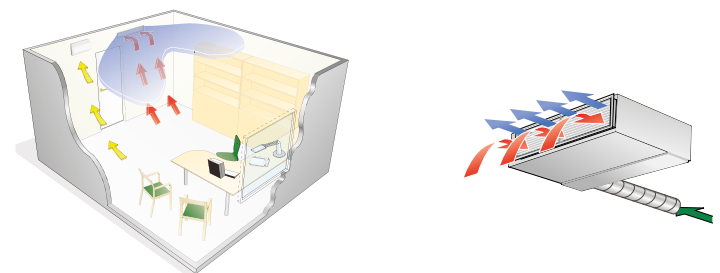

The basic function for cooling, PARAGON Wall

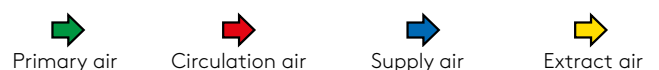

Maximum comfort

Optimised cooling and heating capacity with very low sound level.

Demand-controlled indoor climate

The PARAGON together with the CONDUCTOR room control system provides optimal individual room comfort and economical operation.

Space saving

The low height of the unit provides space for creating more volume and admitting more light into a hotel room entrance, for instance. In extreme cases, the low unit installation height means that you can win a whole extra storey.

PRIMO

Perimeter wall units for maximum room comfort yet they occupy minimal space



PRIMO – a compact climate system with many functions

Despite its compact format, the PRIMO has all the functions that a modern climate system should have for providing high air quality without generating noise or draughts.

The PRIMO can cool, heat as well as ventilate. The PRIMO's low pressure rise makes it a quiet unit and ensures that its energy costs will be low. The built-in control equipment provides a pre-set and pleasant room temperature with individual regulation.

The nucleus in the perimeter wall climate system consists of perimeter wall units of different length. The appropriate unit length is determined in consideration of the current airflow, cooling/heating loads and acoustic requirements. To simplify the installation work and assure the right quality, the dimensions of the prefabricated pipes and ducts are matched to meet the wishes of the client. Several different casings can be selected based on requirements and desired appearance.

Concealed cables

Space is provided within the casing for concealing electric cables, data cables or other cables. No extra cable conduit is necessary.

Modular design

Simplifies the installation work. Simple to change the existing system by adding or removing components.

Space saving

Compact outer dimensions and several different lengths make the PRIMO easy to position.

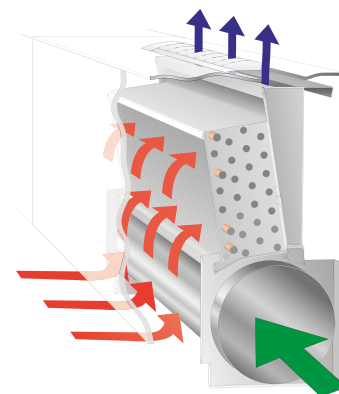

The basic function for cooling



Integrated into suspended ceilings



ADAPT Parasol

Active comfort module for demand-controlled ventilation and Swegon's WISE System or standalone

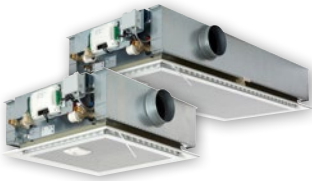

- Energy-efficient operation since the room is ventilated, heated and cooled exactly as needed.
- Highest possible comfort with provision for individual control on a product or room level.
- Draught-free indoor climate, 4-way air distribution and Swegon's ADC provide maximum comfort and flexibility.
- Easy installation, commissioning and maintenance. Complete product with all components and accessories fitted at the factory.
- Built-in control that automatically

Air flow
Up to 85 l/s (300 m³/h)

Capacity
Cool: Up to 2055 W
Heating, water: Up to 2700 W
Heating, electric: Up to 1000 W

Size
600x600 or 1200x600 with adaptations for several ceiling systems.

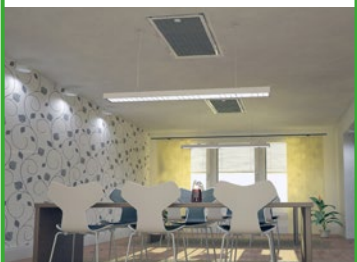

PARASOL VAV

Active comfort module for demand-controlled ventilation, cooling and heating.

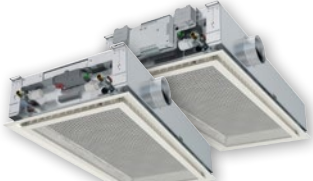

- Gives demand-controlled ventilation together with control equipment Conductor W4.1 VAV.
- Energy-efficient operation since the room is ventilated, heated and cooled exactly as needed.
- Highest possible comfort with control on a room level.
- Draught-free indoor climate, 4-way air distribution and Swegon's ADC provide maximum comfort and flexibility, both today and for future needs.
- Easy installation, commissioning and maintenance. Complete product with all components and accessories fitted at the factory.

Air flow
Up to 85 l/s (300 m³/h)

Capacity
Cool: Up to 2055 W
Heating, water: Up to 2700 W

Size
600x600 or 1200x600 with adaptations for several ceiling systems.



PARASOL

Active, flexible, comfort modules for ventilation, cooling and heating. Also available with electric heating.



- 4-way air distribution with flexible airflow rate and adjustable direction of air discharge for maximum comfort.
- PlusFlow variant with extra large air flows e.g. for conference rooms.
- Air diffusion for maximum comfort regardless of where it is installed in the room.
- Available with installed control equipment and wireless communication.

Air flow
Up to 85 l/s (300 m³/h)

Capacity
Cool: Up to 2055 W
Heating, water: Up to 2700 W
Heating, electric: Up to 1000 W

Size
600x600 or 1200x600 mm.
Height: 220 mm. (PlusFlow: 240 mm.)

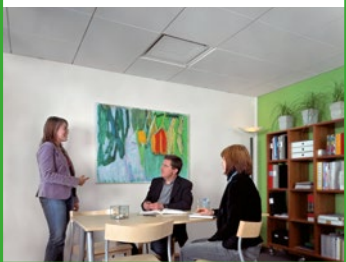

Swegon PACIFIC

Active, climate beam for ventilation, cooling and heating. Also available with electric heating



- Flexible airflow rate and adjustable direction of air discharge.
- Adaptable to meet current requirements before, during and after installation.
- High capacity and excellent comfort properties.
- Connection in series is possible.

Air flow
Up to 55 l/s (200 m³/h)

Capacity
Cool: Up to 2600 W
Heating, water: Up to 3000 W
Heating, electric: Up to 1000 W

Size
Length: 1194 – 3043 mm.
Width: 594 – 667 mm.
Height: 163 – 277 mm.

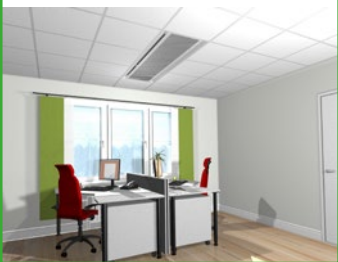

Suspended from the ceiling

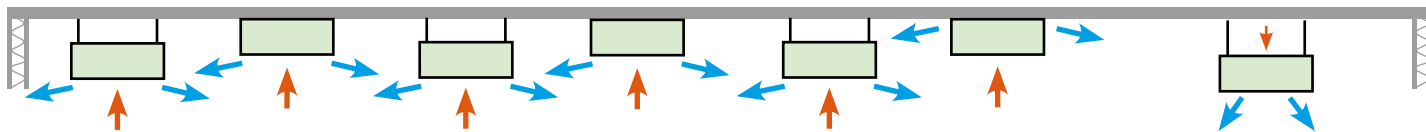

ADAPT Parasol EX

Active comfort module for demand-controlled ventilation and Swegon's WISE System or standalone.

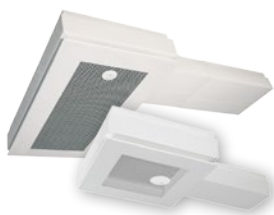

- Energy-efficient operation since the room is ventilated, heated and cooled exactly as needed.
- Highest possible comfort with provision for individual control on a product or room level.
- Draught-free indoor climate, 4-way air distribution and Swegon's ADC provide maximum comfort and flexibility.
- Built-in control that automatically controls the climate.

Air flow

Up to 55 l/s (200 m³/h)

Capacity

Cool: Up to 1930 W

Heating: Up to 2540 W

Size

690x690 or 1290x690 mm

Height: 230 mm



PARASOL EX

Active, flexible, comfort modules for ventilation, cooling and heating.



- 4-way air distribution with flexible airflow rate and adjustable direction of air discharge for maximum comfort.
- Air diffusion for maximum comfort regardless of where it is installed in the room.
- Several perforation patterns as standard. To special order, the perforation design can be one of your own design.

Air flow

Up to 55 l/s (200 m³/h)

Capacity

Cool: Up to 1930 W

Heating: Up to 2540 W

Size

690x690 or 1290x690 with adaptations for several ceiling systems.

Height: 230 mm



ADRIATIC VF

Active, climate beam for ventilation, cooling and heating.



- Flexible airflow rate and adjustable direction of air discharge.
- High capacity and excellent comfort properties.
- Low installation height.

Air flow

Up to 60 l/s (220 m³/h)

Capacity

Cool: Up to 2800 W

Heating: Up to 2600 W

Size

Length: 1200 – 3600 mm.

Width: 363 mm.

Height: 172 mm.

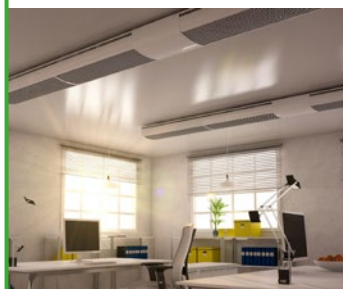

FRB

Passive chilled beams for comfort cooling where ventilation and heating are already installed.



- High capacity even if there are significant differences in temperature between supply and return.
- No moving parts and no flow-generated sound.
- Requires little space.

Capacity

Cool: Up to 1000 W

Size

Length: 1200 – 3900 mm.

Width: 290, 430 mm.

Height: 123, 133 mm.

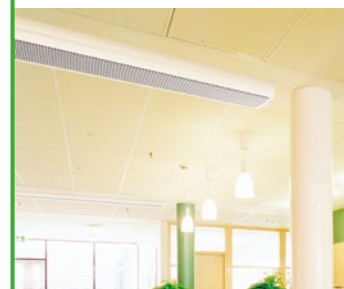

Wall



Facade



PARAGON Wall

Active comfort module for ventilation, cooling and heating of e.g. office rooms.

- Flexible airflow rate and adjustable direction of air discharge.
- Cost-effective solution for refurbishing since the installation work is done in the corridor.
- Unique solution in which the distribution air and circulation air use the same grille.
- Available as high capacity variant where a CCO valve is used to utilise the whole coil for both cooling and heating.

Air flow
Up to 77 l/s (278 m³/h)

Capacity
Cool: Up to 2675 W
Heating, water: Up to 4496W

Size
Width: 775 – 1500 mm.
Height: 264 mm.
Depth: 795 mm.



PARAGON

Active comfort module for ventilation, cooling and heating of e.g. hotel rooms and hospital rooms.

- Flexible airflow rate and adjustable direction of air discharge.
- Plug and Play installation with integrated control equipment.
- Low installation height.
- Available as high capacity variant where a CCO valve is used to utilise the whole coil for both cooling and heating.

Air flow
Up to 77 l/s (278 m³/h)

Capacity
Cool: Up to 2820 W
Heating, water: Up to 4580 W

Size
Width: 775 – 1500 mm.
Height: 220 mm.
Depth: 765 mm.

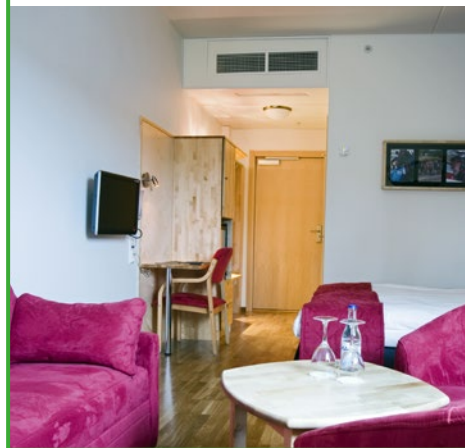

PRIMO

Active air conditioning system for ventilation, heating (electric or water) and cooling for location along a perimeter wall.

- Also heats without ventilation by means of natural convection.
- Highly adaptable for matching their appearance to a specific décor.
- Up to 10 units can be connected in series.

Air flow
Up to 45 l/s (160 m³/h)

Capacity
Heating, water: Up to 2030 W
Heating, electric: Up to 1000 W
Cool: Up to 1930 W

Size
Length: 600 – 1600 mm.
Height: From 365 mm.
Depth: From 183 mm.

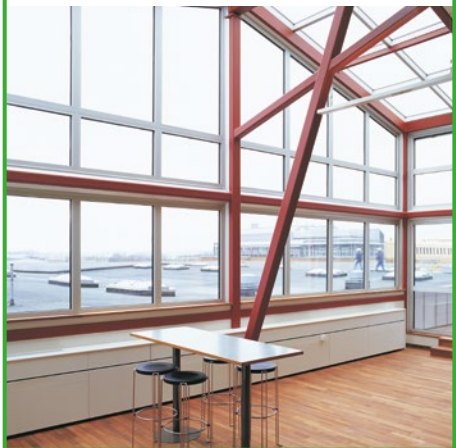

Control equipment

Temperature, airflows and communication

CONDUCTOR

The optimum solution for individual control of the temperature and airflow in each room. Can be easily modified for either demand-controlled or constant airflows. Communication is possible with Swegon's WISE system and with external supervision systems via Modbus.

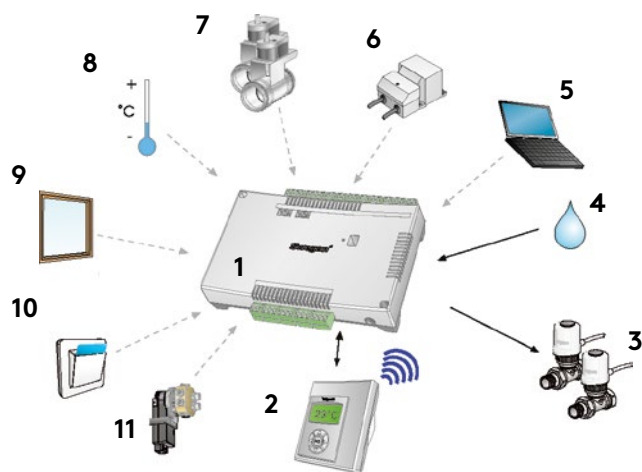

- 1 = Controller
- 2 = Room unit with wireless or wired communication
- 3 = Valve actuator for cooling and heating water
- 4 = Condensate sensor

As required:

- 5 = Communication via Modbus
- 6 = Transformer
- 7 = Motorised ventilation damper
- 8 = External temperature sensor
- 9 = Window contact
- 10 = Key card holder or presence sensor
- 11 = CCO valve (PARAGON and PARAGON Wall)



LUNA

Control equipment in simpler systems with constant airflows and without provision for communication. The control equipment operates completely independently and controls the room temperature.

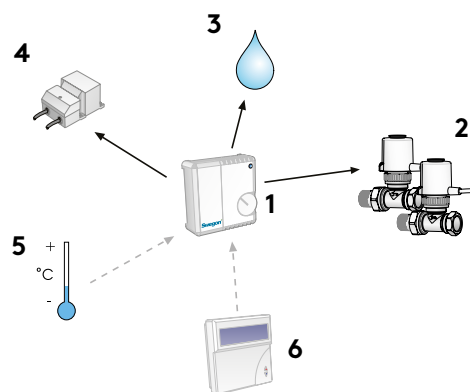

- 1 = Room controller with room thermostat
- 2 = Valve actuator for cooling and heating water
- 3 = Condensate sensor

As required:

- 4 = Transformer
- 5 = External temperature sensor
- 6 = Hand unit for changing the factory settings

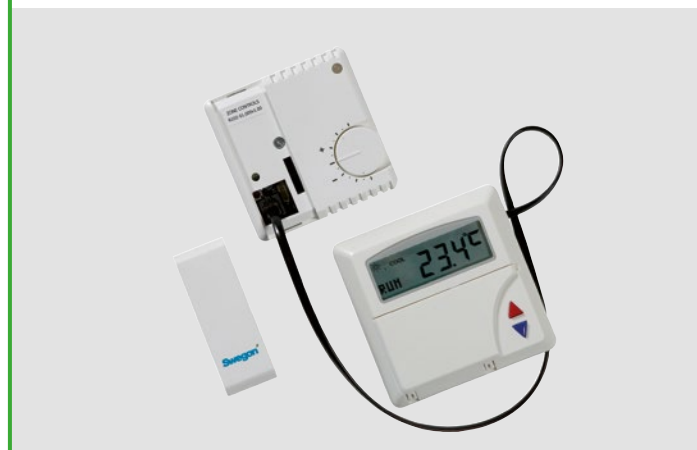

Swegon – The systems supplier!

Swegon can offer specific products in most product areas that deal with air handling. However, the end user will benefit mostly from our products if they are supplied in the form of system solutions. We then take responsibility for seeing to it that the products are simple to install, save floor space and operate in harmony to provide the highest possible degree of comfort and use the least possible amount of energy. Our control systems with open communication also save substantial costs otherwise spent on external control equipment.

Swegon personnel are there to help you with customised system solutions for specific applications to the extent required.

Swegon also offers complete platform solutions, Swegon Solutions.

All Swegon Solutions have an interacting open-loop and closed-loop control functionality which can be used as a "Stand-alone" system, thanks to its built-in web pages, or can simply communicate with a main control system. These platforms not only make your sizing work simpler, they also substantially reduce the operating costs, thanks to the optimising of the pressure conditions in the system, demand-controlled airflows, the control of light fixtures and the distribution of water, etc.

SwegonSolutions

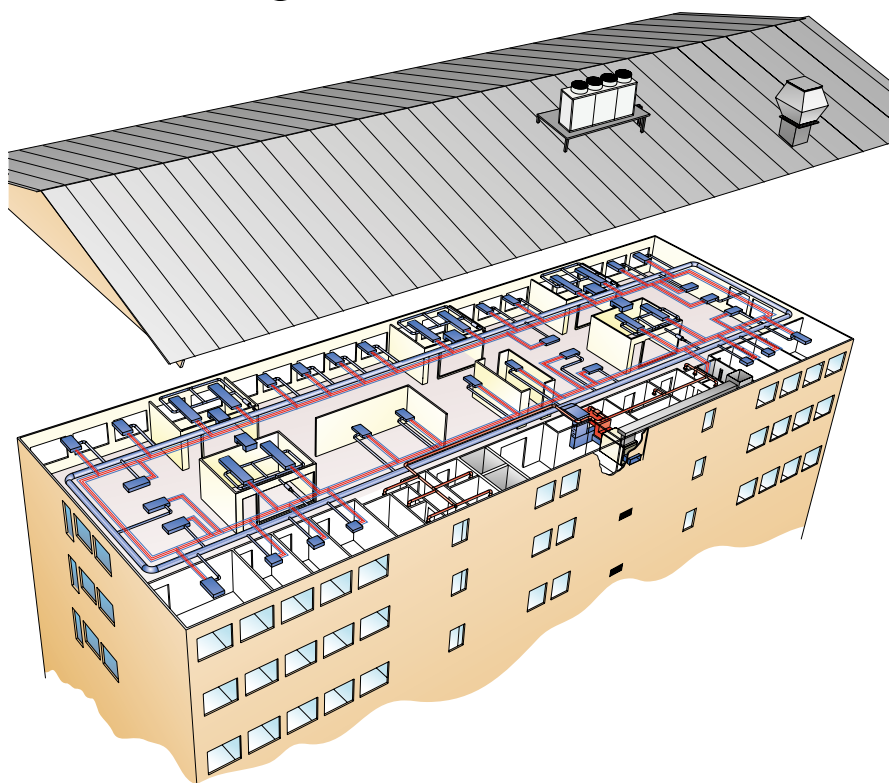

Example:

**Chiller/heat pump
MULTI-functional unit**

Air handling unit

**Air cooler
air heaters**

**Climate beams and
comfort modules**



The air handling unit supplies free cooling when the temperature conditions allow it.

Whenever cooling or heating is required, the multi-functional unit simultaneously supplies chilled water or hot water to the air cooler, air heater and climate beams.

Waterborne climate systems from Swegon are installed here



ANZ Tower, Auckland, New Zealand



Johns Hopkins, Baltimore, USA



Main Point Karlin, Prague, Czech Republic



Siege de Etde, Saint Herblain, France



PWC, Oslo, Norway



citizenM, London, Great Britain



Green Hall, Vilnius, Lithuania

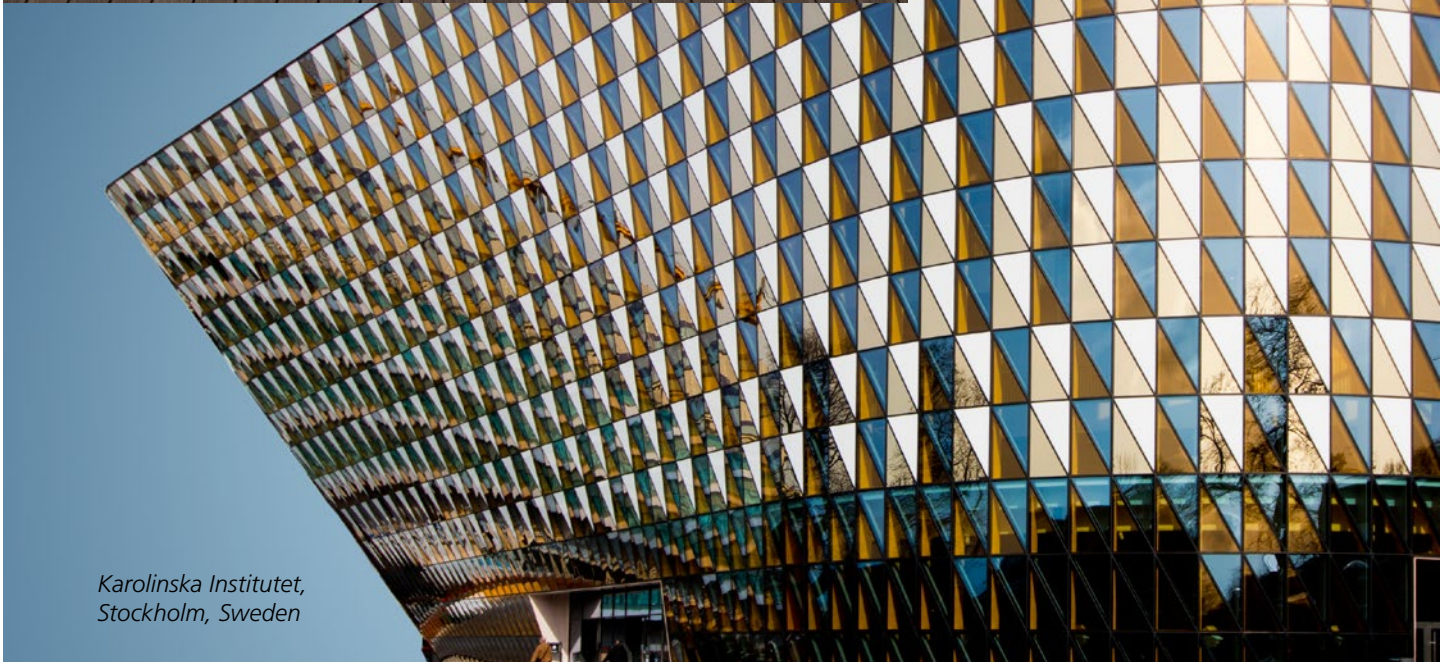

*Karolinska Institutet,
Stockholm, Sweden*

We make every breath count.