

# CG IV-KIT-m

Mounting - condensation sensor / Montering - kondensgivare 20170512

To be mounted on: PARASOL, PARASOL Zenith, PARASOL EX, PARASOL VAV, PACIFIC (Only for Conductor control platform and PACIFIC SA/EA, ADAPT Parasol, ADAPT Parasol EX)

För montering på: PARASOL, PARASOL Zenith, PARASOL EX, PARASOL VAV, PACIFIC (Endast för Conductor plattformen samt PACIFIC SA/EA, ADAPT Parasol och ADAPT Parasol EX)

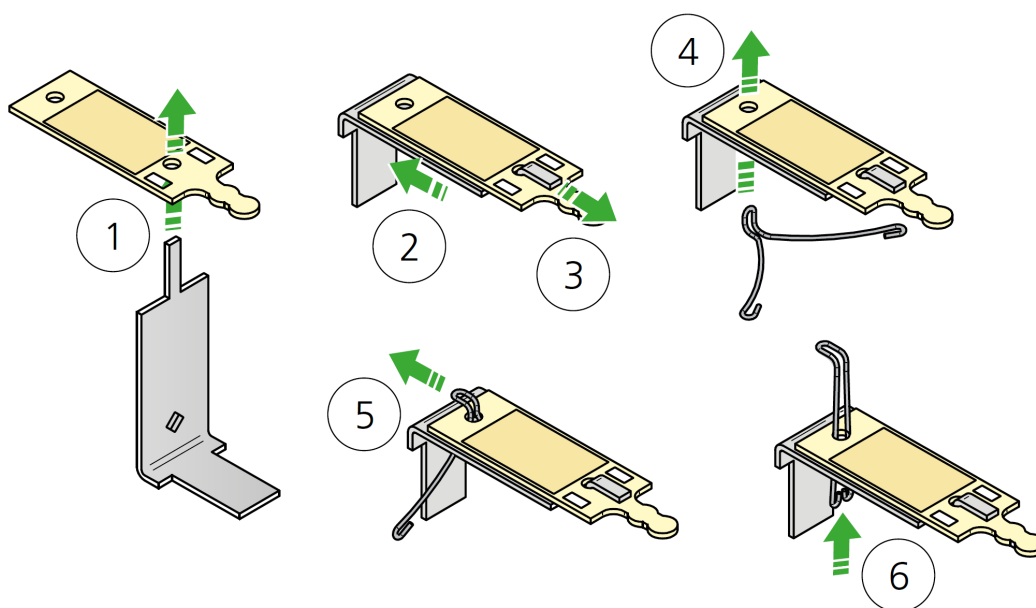
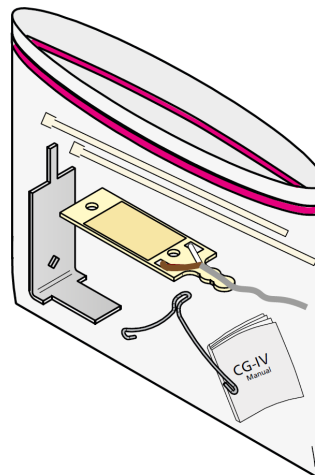

Swegon

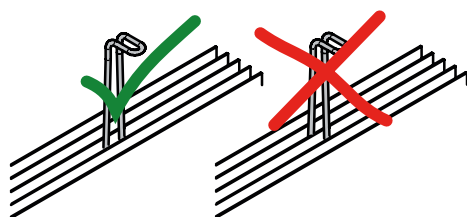
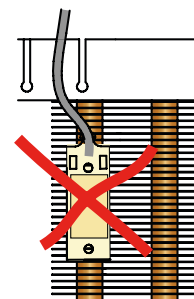
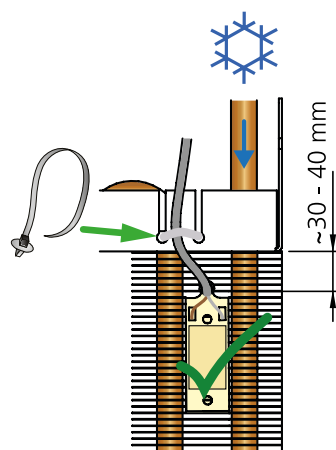
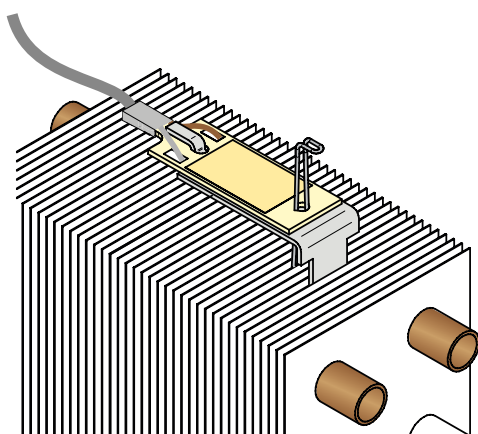
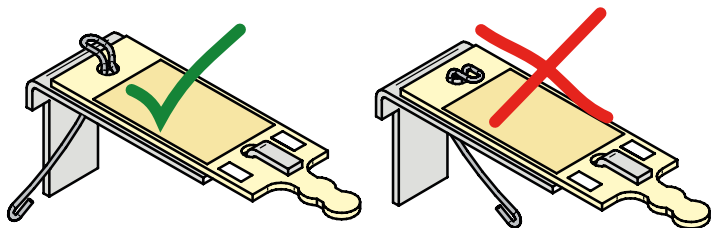

## PACIFIC

Vy från undersidan / Bottom view

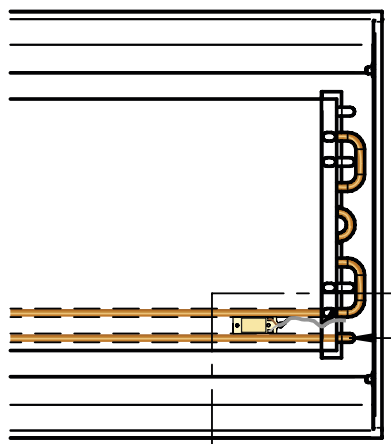

Tillopp Kyla/  
Cooling supply

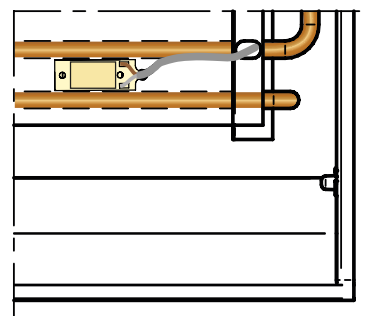

# PARASOL Zenith 1200/1800

Vy från undersidan / Bottom view

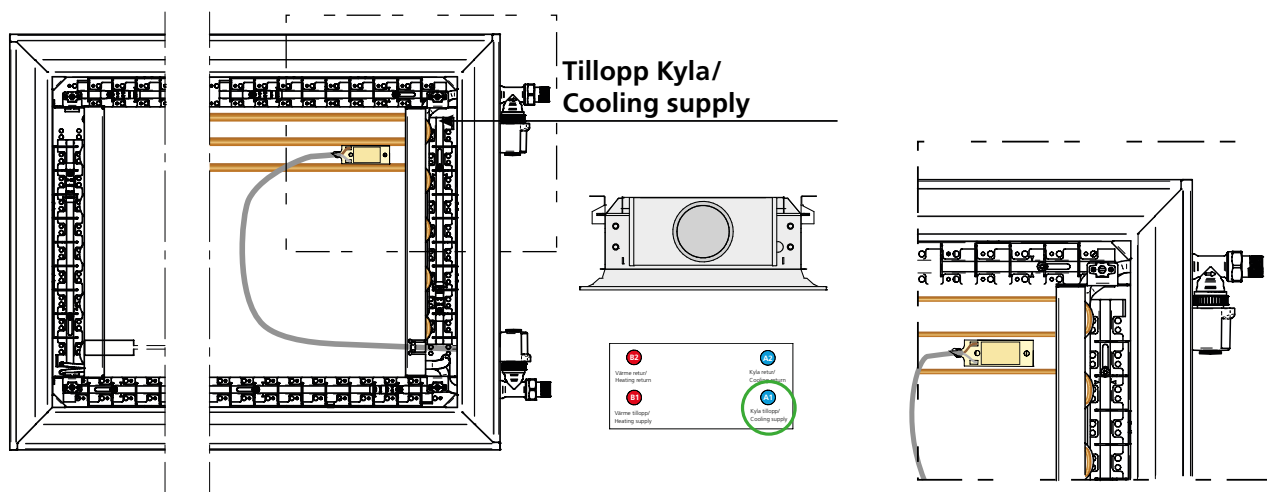

# PARASOL 600

Vy från undersidan / Bottom view

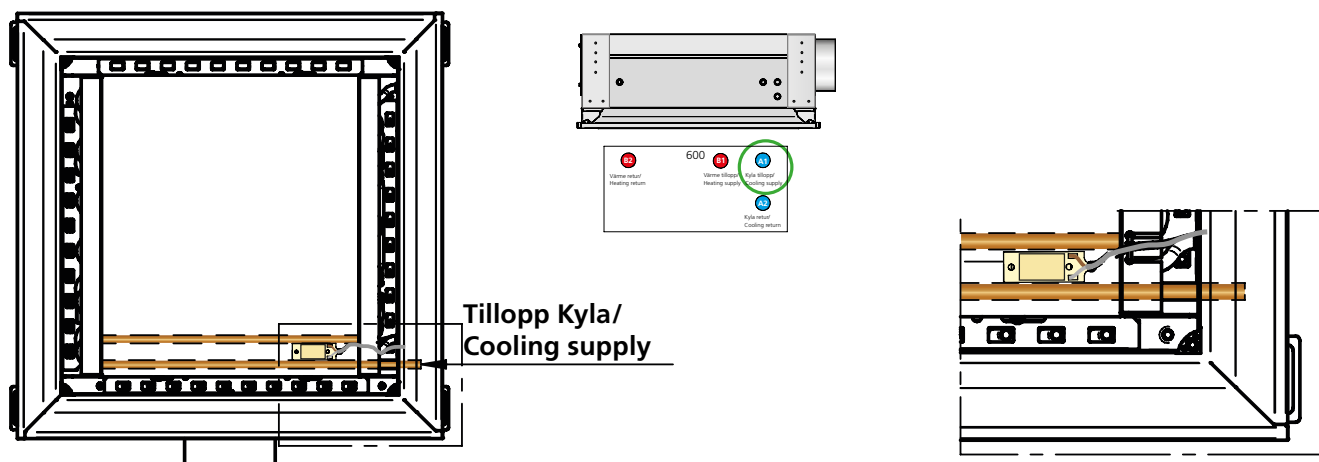

# PARASOL 1200

Vy från undersidan / Bottom view

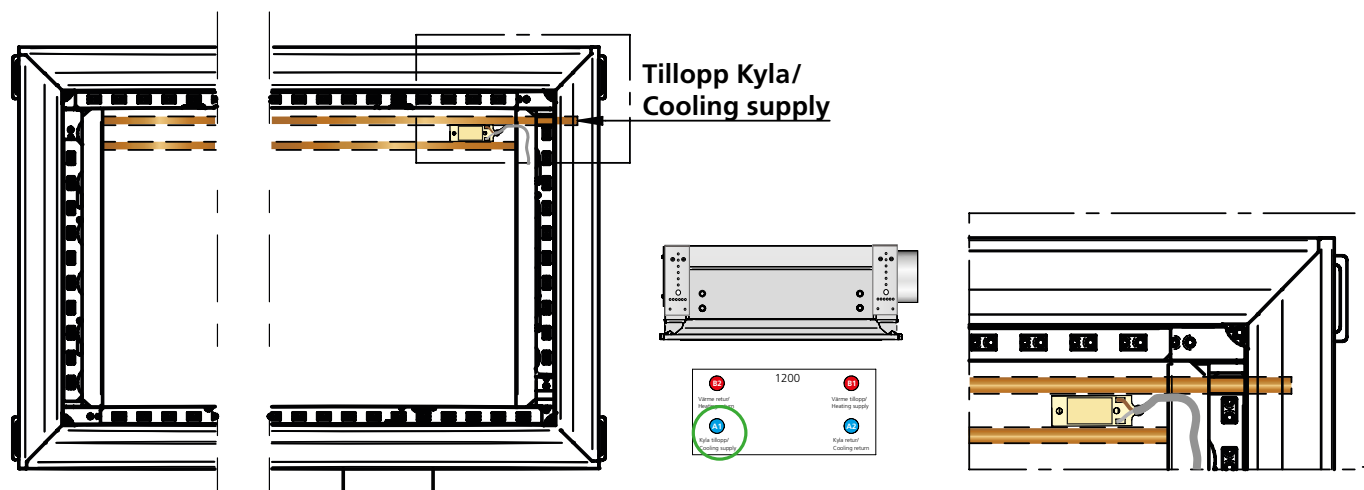

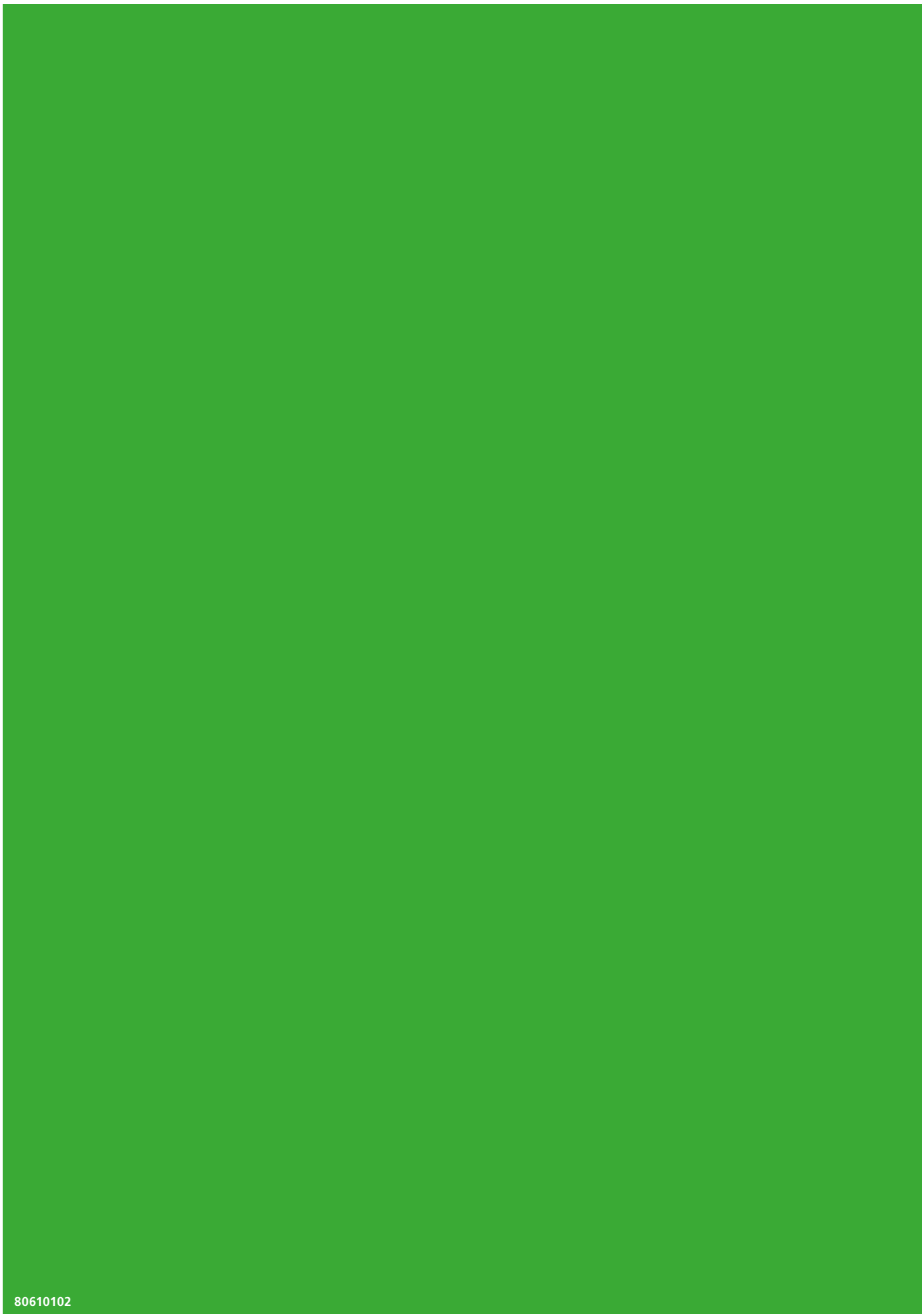

80610102