

# WCD2 PARAGONc

Installation – Condensation sensor

20180315

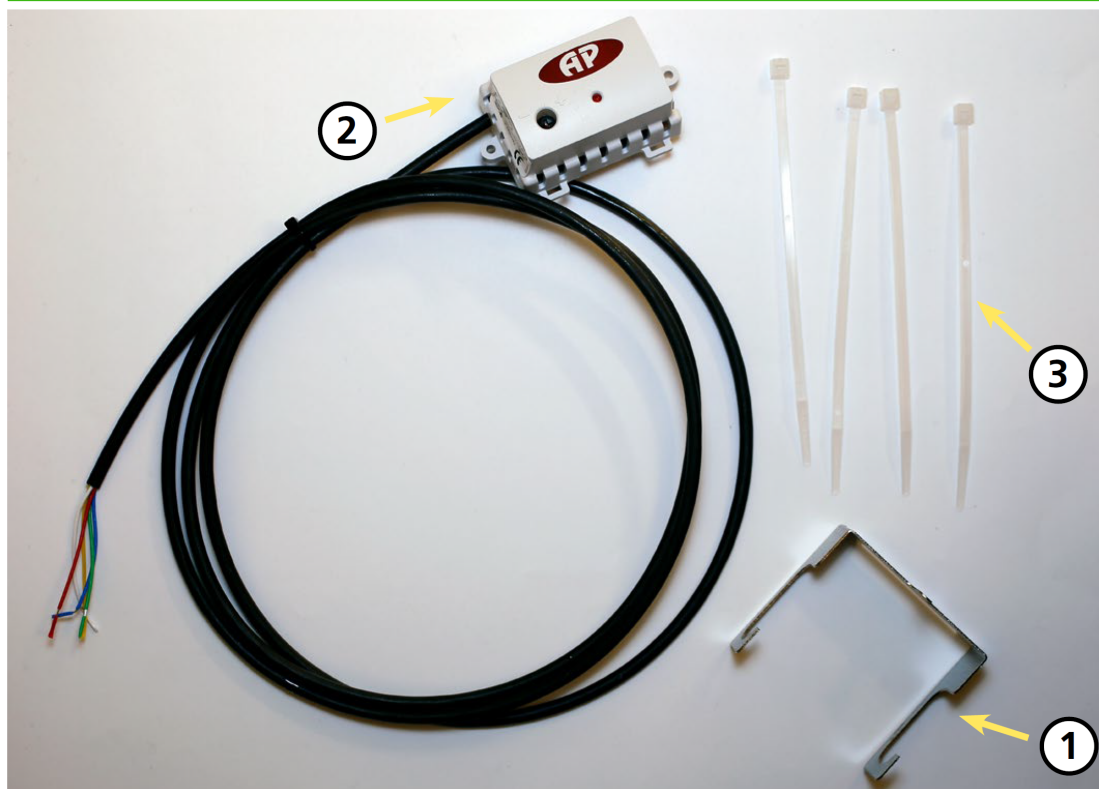

## General description of the Condensation Sensor WCD2 - PARAGON.

The Sensor WCD2 PARAGON is designed to meet the requirements to provide early warning of condensing conditions. In case of a problem with the system the sensor is used as a safeguard to avoid condensation from the chilled beam.

The sensor operates on dew point temperature rather than a fixed value of relative humidity.

The dew point is calculated from a temperature compensated RH element and a high accuracy thermistor which are thermally bonded to the metal plate of the sensor.

The volt-free contact relay in the sensor is activated when the dew point temperature is below the calculated dew point temperature (there is a safety factor included in the calculated dew point).

### LED Indication.

The red LED, visible through the top of the housing, has 4 functions.

1. Short blink once every 15 seconds to show the device is working properly
2. Rapid continuous blinking to show the dew point switching set point is close
3. Continuously ON when the output is switched on.
4. On long flash followed by 2 short flashes to show the temperature element is faulty.

**Swegon**

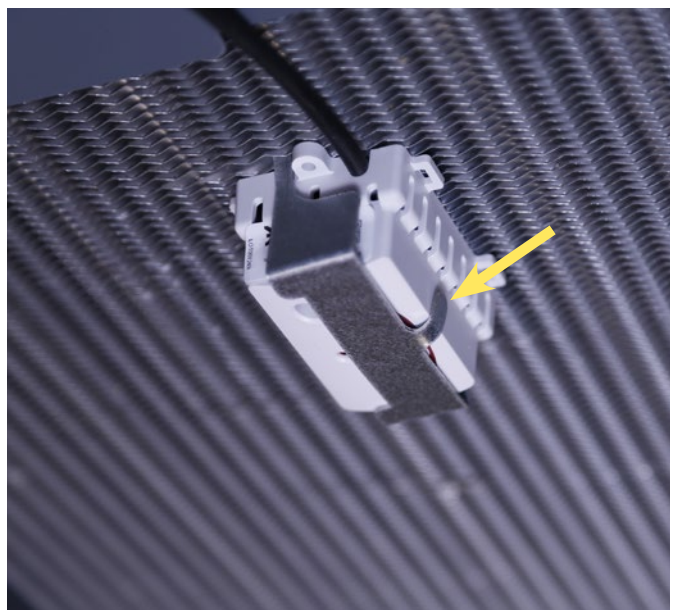
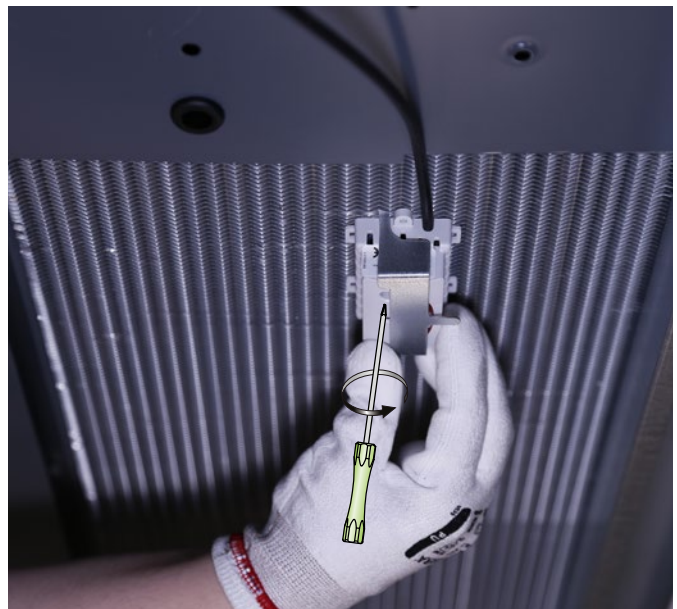
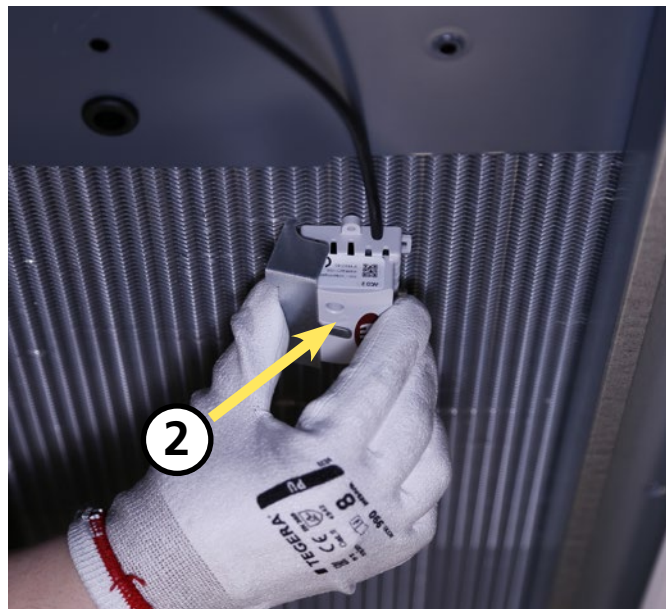
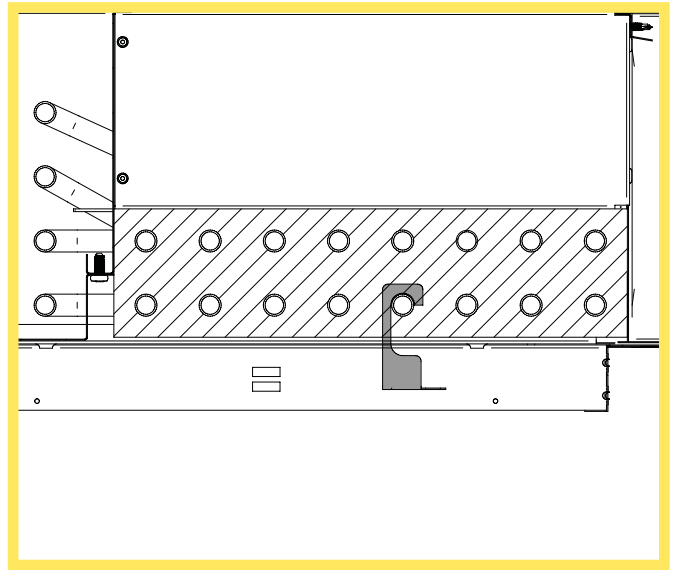
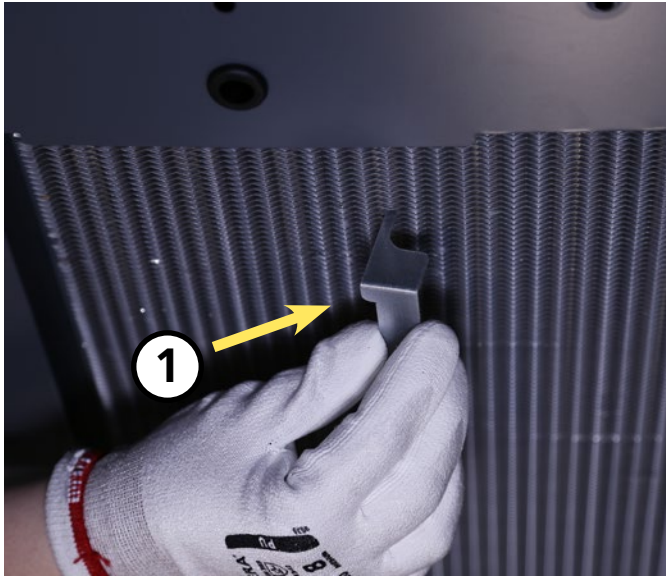

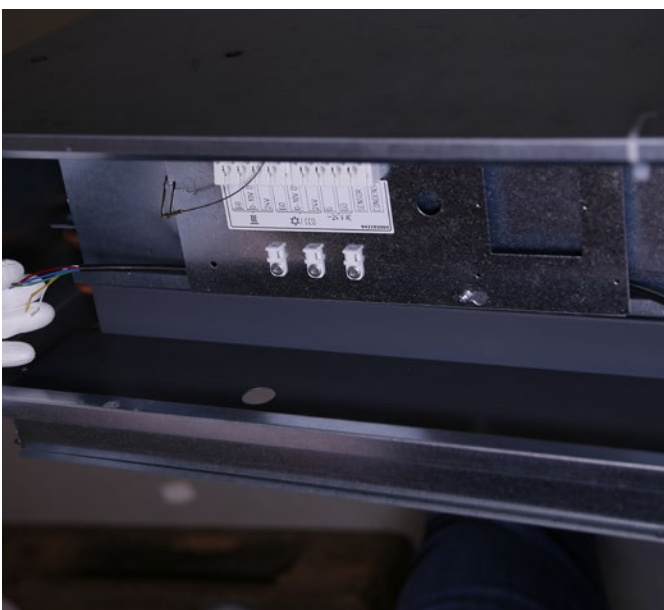
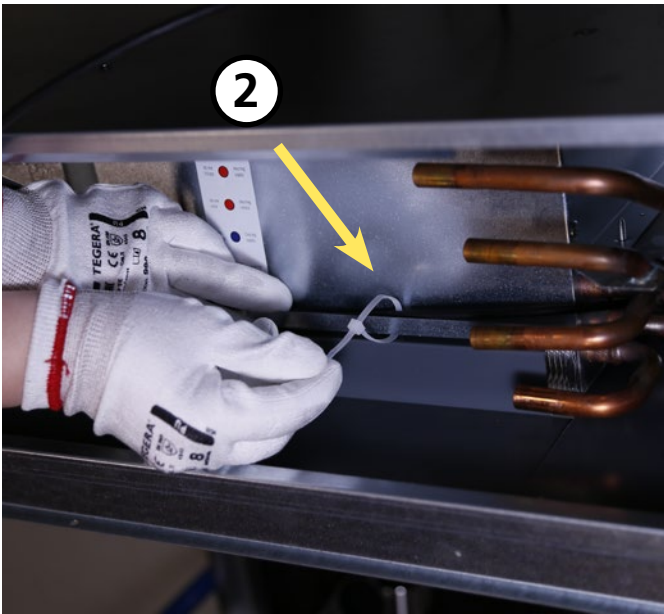
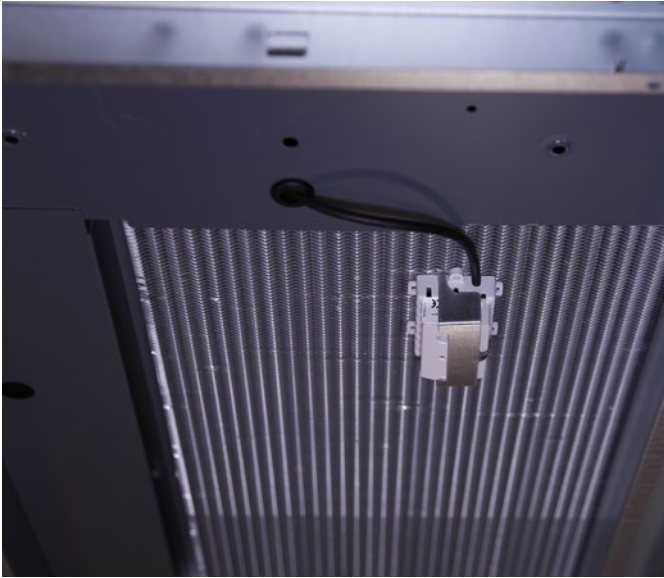

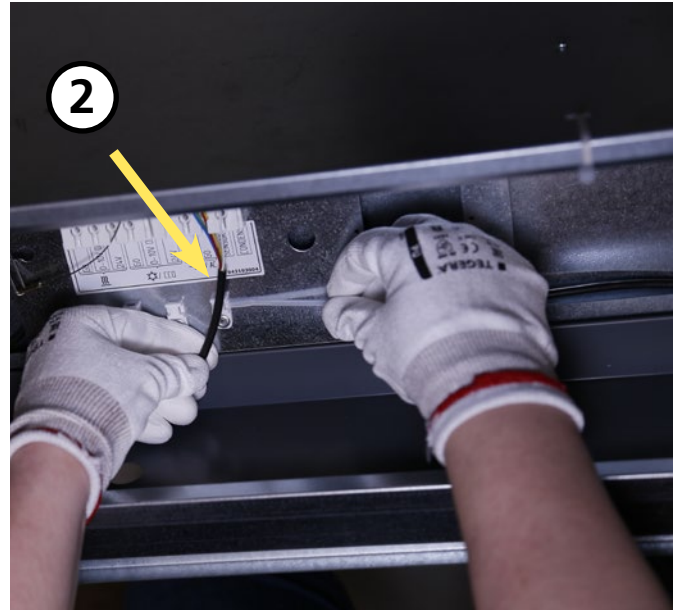
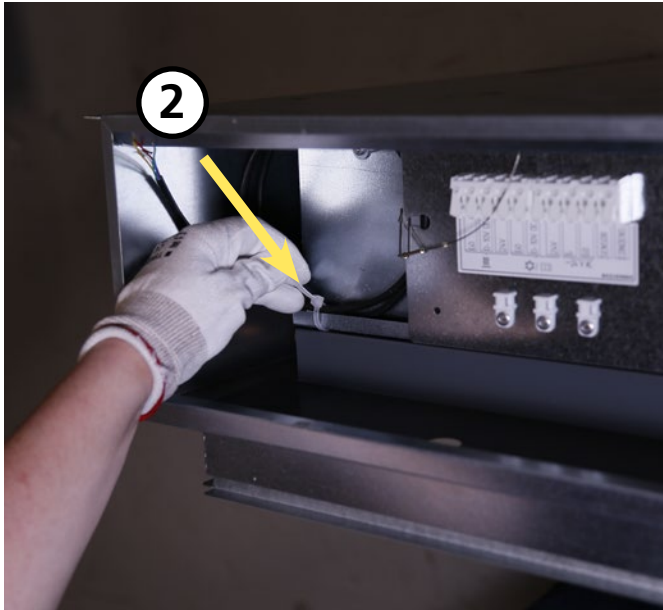

To connect condensation sensor WCD2 to PARAGON with Plinth

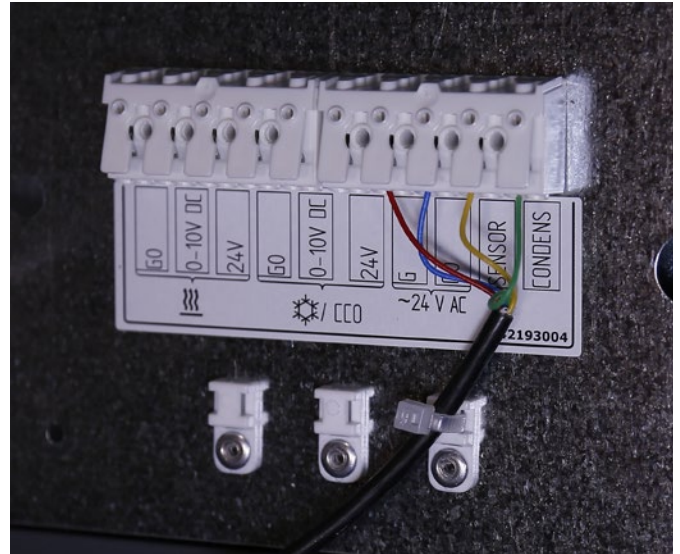
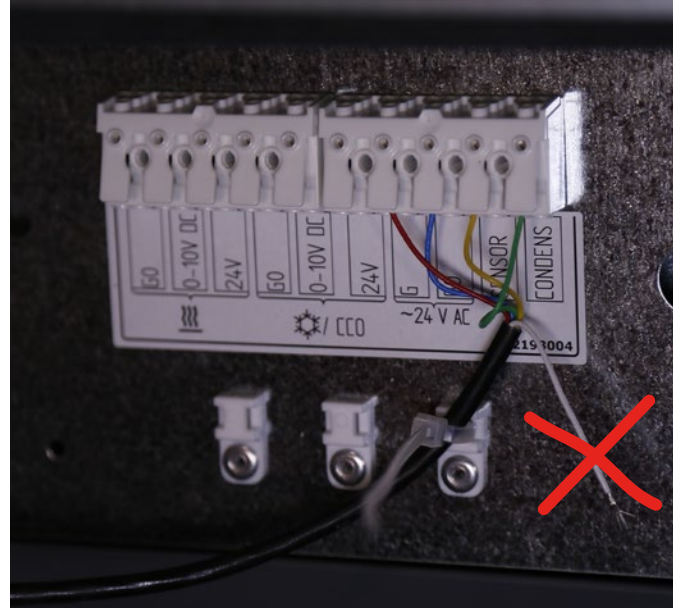

PARAGON/PARAGON Wall with Plinth

	Colour	Plinth
Condensation sensor WCD2	Red	G
	Blue	G0
	Yellow	SENSOR
	Green	CONDENS
24 V AC	Black	G
	Grey	G0

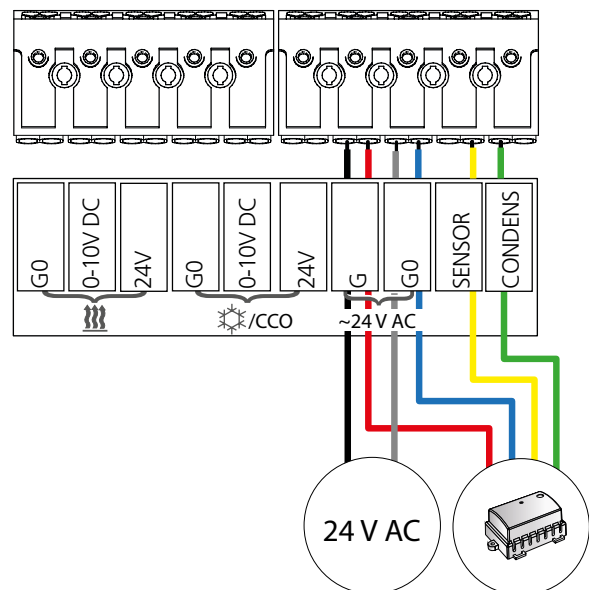

To connect condensation sensor WCD2 to PARAGON with WISE IORE

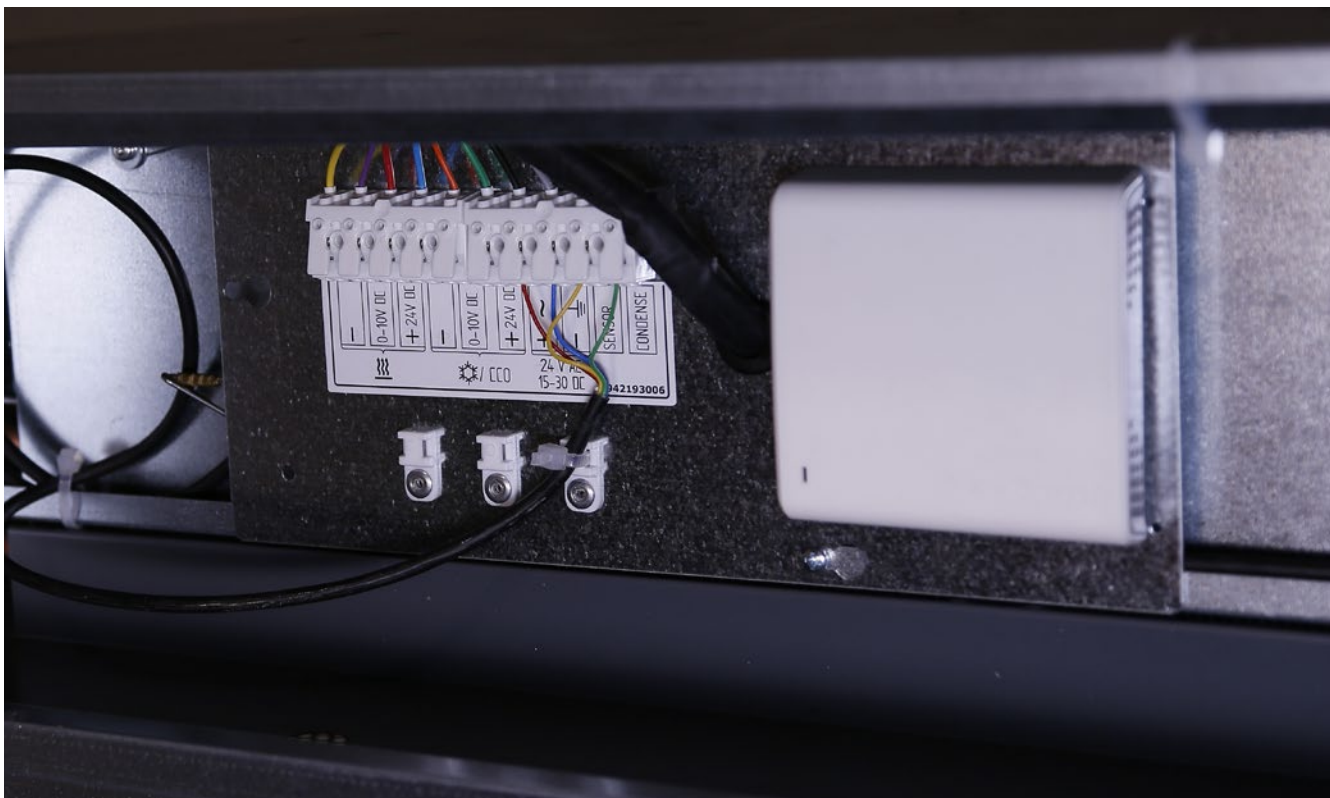

PARAGON/PARAGON Wall with WISE IORE

	Colour	Plinth
Condensation sensor WCD2	Red	+ ~
	Blue	- ~
	Yellow	SENSOR
	Green	CONDENS
24 V AC 15-30 DC	Grey	- ~
	Black	+ ~

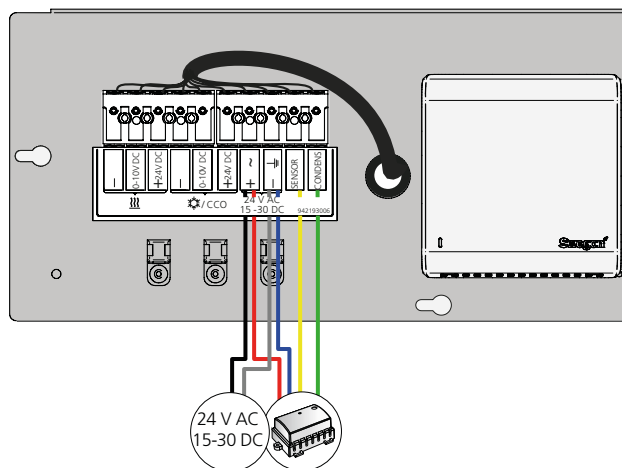

To connect condensation sensor WCD2 to PARAGON with CONDUCTOR

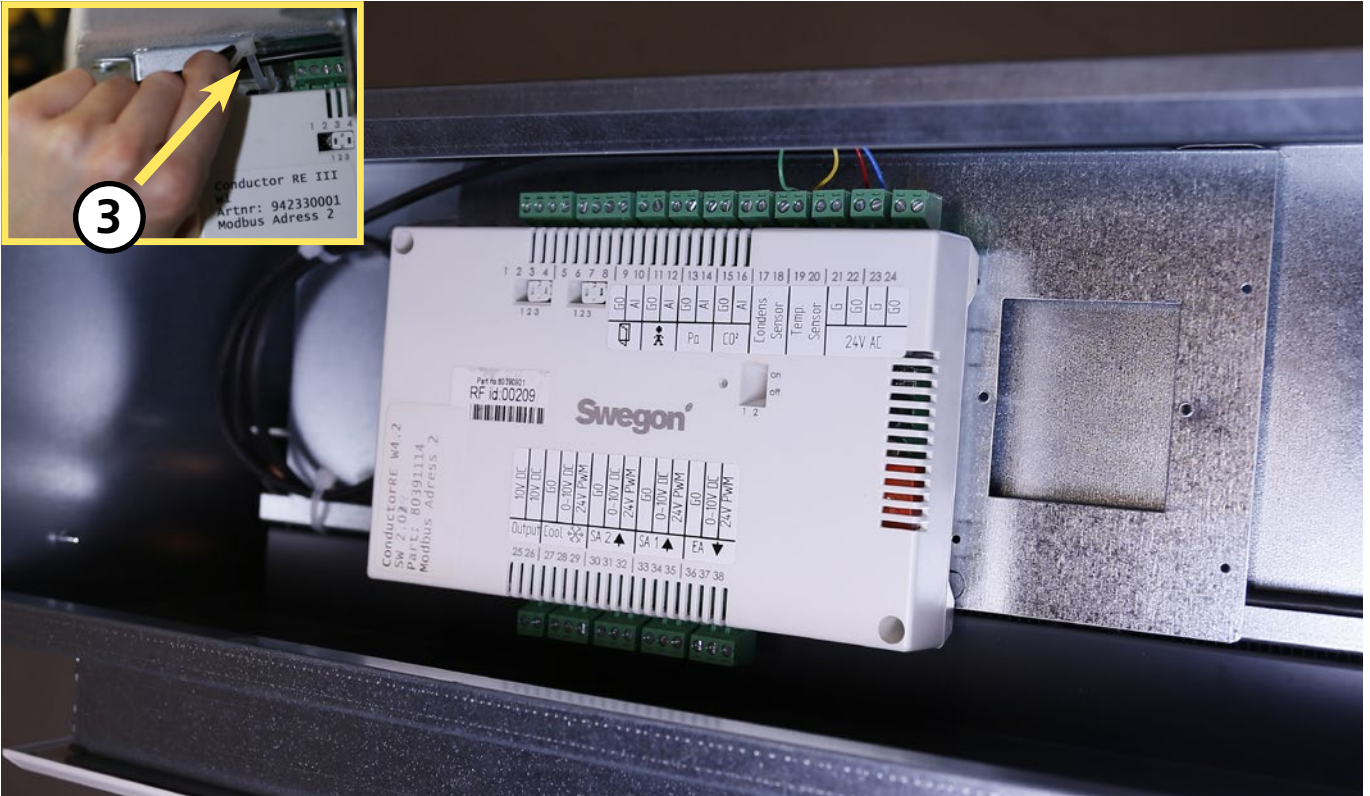

PARAGON/PARAGON Wall with CONDUCTOR

	Colour	Conductor RE
Condensation sensor WCD2	Green	17
	Yellow	18
	Red	21
	Blue	22
24 V AC	Grey	23
	Black	24

