

Description of the air handling unit

GOLD PX



GOLD RX



GOLD SD



GOLD CX



Contents

General, Range of Application, Certification	2
Mechanical Design	3
Electrical and Control Equipment	9
Hand-Held Micro Terminal and How to Use the Menus	10
Control Schedule.....	11
Delivery Version.....	17
Installation Tips	18

Description of the Air Handling Unit



General

The GOLD RX/PX/CX air handling units are complete with direct-driven supply air and extract air fans, supply air and extract air filters and heat exchanger. The heat exchanger is either a rotary heat exchanger (RX), counterflow heat exchanger (PX) or coil heat exchanger (CX).

The GOLD SD single-direction units are supply air/extract air handling units with one direct-driven supply air or extract air fan. A filter is available as an option for all sizes. The coil heat exchanger and unmounted pipework package can be selected for the size 012-120 units.

The GOLD has built-in control equipment that can be operated from the hand-held micro terminal in the form of a touchscreen.

The electrical and control system is completely integrated into the air handling unit. The microprocessor-based equipment controls and regulates temperatures, airflows and other functions. A large number of functions are built into the system and are simple to activate.

If supplementary functional sections such as dampers and air coolers are required, they must be installed in the ductwork (uninsulated duct accessories) or be docked to the air handling unit (insulated duct accessories). Unit sections such as e.g. the multisection and air bypass section can be installed in the air handling unit arrangement of the size 004-120 RX/PX/CX units.

With provision for cooling and heating

The GOLD is also well suited for cooling and heating. Control functions are ready to activate in the control system and the equipment for cooling as well as for pre-heating and reheating are available as accessories.

Field of Application

The GOLD units are designed for use in comfort ventilation applications. Depending on the variant selected, GOLD units can be utilized in buildings such as office buildings, schools, day nurseries, public buildings, shops, residential buildings, etc.

GOLD units equipped with counterflow-/coil heat exchanger (PX/CX) and separate supply air and extract air handling units (SD) can also be used for the ventilation of moderately humid buildings; however not where the humidity is continuously high, such as in indoor swimming baths.

The separate GOLD supply air and extract air handling units (SD) are designed for applications in which the supply air and extract air flows need to be completely separated from one another or where, due to limited available space, separate units for supply air and extract air are needed. They can also be used individually if only one of the variants is needed.

GOLD units equipped with the roof, air intake section and exhaust air hood accessories can be installed outdoors.

The GOLD is designed and tested for temperatures, in the surroundings and the air stream, from -40°C to +40°C.

Certification

Swegon has a certificated quality management system that conforms to ISO 9001 and an environmental management system that conforms to ISO 14001 Standards. The GOLD air handling system is also certificated by Eurovent, No. AHU-06-06-319 and the Passive House Institute.



www.eurovent-certification.com
www.certiflash.com



Sensor designations and colours of arrows in this publication conform to IEC 81346-1

Description of the Air Handling Unit

Mechanical Design

Casing of the GOLD RX/PX/CX

Composed of flush-mounted cover panels and inspection doors. The outer skin is made of galvanized sheet steel, re-painted in Swegon's own grey metallic paint (closest comparable RAL colour: 9007). The inner skin is made of aluminium-zinc plated sheet steel. The entire air handling unit conforms to Environmental Class C4. CE marked. Conform to the provisions of EN 61000-6-2 and EN 61000-6-3 Standards. Panel thickness of 52 mm with intervening insulation consisting of mineral wool.

The inspection doors are hung on hinges and are fitted with flush-mounted door handles. The door handles must be opened in two steps to equalise the pressure before the door can be opened completely.

Casing performance

Air leakage, class: L1(M).

Thermal bridges: TB2.

Thermal transmission: T2.

Mechanical strength D3 (M).

Applicable to sizes 004/005 and 007/008 inside a common casing:

Common casing with two inspection doors. One of the door handles of each inspection door can be locked.

The safety isolating switch is located on the outside of the connection hood.

Circular duct connections for insertion joints fitted with a rubber seal ring as standard.

The GOLD RX with rotary heat exchanger can be mounted on base beams, a foundation or on a stand. Pre-fitted base beams are obtainable as optional equipment; a stand supplied unmounted is available as an accessory.

GOLD PX units with counterflow heat exchanger are supplied with base beams. A set of legs (four legs) to be screwed into the base beams is available as an accessory.

Applicable to sizes 004/005 and 007/008 in split version as well as size 011-120:

The basic arrangement of the size 004-080 units consists of three unit sections (two fan/filter sections and one heat exchanger section). The size 100/120 units consist of five (RX) or six (CX) sections.

Each section/unit section has one or two inspection doors. One of the handles for each one of both outer inspection doors is lockable. On the size 120 units, the inspection door of the heat exchanger section (GOLD RX) is also lockable.

The size 014-120 units are equipped with rectangular duct connections for slip-clamp jointing as standard. The size 004-012 units are equipped with circular duct connections for insertion joints fitted with a rubber seal ring as standard.

The unit is equipped with base beams.



GOLD RX, size 008



GOLD RX, size 030



GOLD PX, size 012, full face end connection panel

On the size 004-020 units, the safety isolating switch is externally located on the connection hood.

On the size 025-120 units, the safety isolating switch is externally located on the heat exchanger section of the unit.

Description of the Air Handling Unit

Mechanical Design

Casing of the GOLD SD

Composed of flush-mounted cover panels and inspection doors. The outer skin is made of galvanized sheet steel, re-painted in Swegon's own grey metallic paint (closest comparable RAL colour: 9007). The inner skin is made of aluminium-zinc plated sheet steel. The entire air handling unit conforms to Environmental Class C4. CE marked. Conform to the provisions of EN 61000-6-2 and EN 61000-6-3 Standards. Panel thickness of 52 mm with intervening insulation consisting of mineral wool.

The inspection doors are hung on hinges and are fitted with flush-mounted door handles. The door handles must be opened in two steps to equalise the pressure before the door can be opened completely.

Casing performance

Air leakage, class: L1(M).
 Thermal bridges: TB2.
 Thermal transmission: T2.
 Mechanical strength D3 (M).

Applicable to sizes 004/005 and 008:

Common casing with one inspection door. The handles are lockable.

Space for pleated filters of Filter Class M5 or F7 is available and can be ordered as an accessory (not included as standard).

The safety isolating switch is located on the inspection side by the handle on the fan inspection door.

Circular duct connections for insertion joints fitted with a rubber seal ring as standard.

The GOLD SD units can be mounted on base beams, a foundation or on a stand. Prefitted base beams are obtainable as optional equipment; a stand supplied unmounted is available as an accessory.

Applicable to sizes 012:

Composed of one or two sections depending on the variant selected. Possible variants are fan (with space for a filter) or fan (with space for a filter) + coil heat exchanger.

The fan section casing has two inspection doors. The handles are lockable.

Space for a pleated filter of Filter Class M5 or F7 is available and can be ordered as an accessory.

The safety isolating switch is located on the inspection side by the inspection door of the fan section.

Circular duct connections for insertion joints fitted with a rubber seal ring as standard.

The unit is equipped with base beams.



Sizes 004/005 and 008



Sizes 014-080

Shows the variant with functions: filter + coil heat exchanger + fan.

Applicable to sizes 014-120:

Composed of one to three sections depending on the variant selected. Possible variants are fan, filter + fan or filter + coil heat exchanger + fan.

The sections for fan and filter have their own inspection door. One of the door handles of the outer inspection door can be locked.

The safety isolating switch is located on the inspection side.

Rectangular duct connections for slip-clamp joint connection as standard.

The unit is equipped with base beams.

Description of the air handling unit

Mechanical Design

Fans

The direct-driven fans are of GOLD Wing+ type, unique axial-centrifugal fans with the focus on excellent power efficiency, uniform airflow and low noise level. The GOLD Wing is patented. Functional sections such as air coolers and bends can be connected directly against the air handling unit without appreciable pressure losses. This saves space in the fan room.

The fans are driven by high-efficiency EC motors, which together with a motor control system especially developed for the GOLD, perform with extremely high efficiency.

The fans are approved for operation in temperatures of up to 40°C.

The fan motors have a motor control system for variable speed regulation and the fans have measurement tapings for continuous measurement and regulation of the airflow.

The fans are effectively vibration-isolated from the casing by means of rubber bushings/flexible connections.

The fans are fixed in their positions by means of locking knobs/screws and clamping bands. These fasteners can easily be loosened, after which the entire fan package can be withdrawn for inspection and maintenance.



Filters

The filter material is glass fibre. The filter holder has a filter locking system designed for effective sealing and complies with the requirements for bypass leakage to Class F9. All filters can be selected as M5 or F7 filters.

The size 014–030 GOLD RX/PX one-piece units with rotary or counterflow heat exchanger with air intake from above, and the size 004-012 GOLD RX Top units are equipped with pleated filters.

The separate GOLD SD supply air and extract air handling units in sizes 004-012 can have pleated filters as an option.

The units in other sizes have bag filters of ample proportions on both the supply air and outdoor air sides.

Pressure sensors for measuring the pressure drop across the filters are incorporated into the control system.

Pre-filter inside air handling units

Prefilters installed inside air handling units can be ordered as optional extras (does not apply to the type RX Top units).



Prefilters are used in ventilation systems, in which the extract air and/or the outdoor air is/are heavily polluted and it is desirable to prevent the fine filters inside the GOLD unit from becoming clogged after a short period of use.

the filters are of woven aluminium type or Class G4 compact filters.

Pressure sensors for measuring the pressure drop across the filters are incorporated into the control system.

Description of the Air Handling Unit

Mechanical Design

Heat exchanger

Rotary heat exchanger

RECOeconomic/RECOsorption rotary heat exchanger with a temperature efficiency of up to 85%. The need for heat is dealt with by automatically and variably regulating the speed of the rotor.

The rotary heat exchanger effectively recovers cooling energy as well.

It is available in a sorption version (RECOsorption) for moisture recovery, which reduces operating and investment costs for cooling and improves indoor comfort levels in the winter, as well as in an epoxy-treated version.

Purging sector, commissioning plates and pressure measurement tappings as standard, ensure that the extract air will not be carried over to the supply air.

The RECOeconomic/RECOsorption heat exchanger is patented.

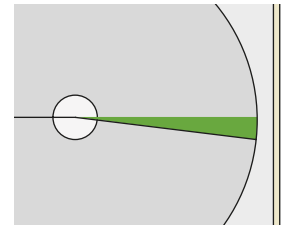

Purging sector

Counterflow heat exchanger

The counterflow heat exchanger is as standard equipped with centre-mounted bypass dampers and two heat exchanger dampers for variable and automatic regulation of the heat exchanger's efficiency on heat recovery.

The counterflow heat exchanger is available in two versions: Normal efficiency (MPE, Maximum Pressure Efficiency) and high efficiency (MTE, Maximum Temperature Efficiency) respectively. In the MPE version, the focus is on low pressure drop across the heat exchanger. In the MTE version, priority is given to high temperature efficiency.

Internal leakage between air streams conforms to the provisions of Ductwork leakage class L2.

In cold weather, and when the extract air is humid, there is risk of frosting inside the plate heat exchanger. The GOLD PX is therefore equipped with anti-frost protection.

RECOfrost anti-frost protection

The pressure drop across the heat exchanger, extract air temperature, moisture content in the extract air and outdoor air temperature are measured.

With consideration given to the pressure drop across the heat exchanger, the extract air temperature, the moisture content in the extract air and the outdoor air temperature, the control system individually regulates dampers for bypass and the heat exchanger for section-by-section defrosting without the formation of frost. This enables high annual efficiency, smaller air heaters and pressure-drop-optimized operation during the spring and autumn.



Description of the Air Handling Unit

Mechanical Design

Coil heat exchanger

The coil heat exchanger in the one-piece units, GOLD CX, sizes 035-080, are supplied complete from the factory; including mounted pipework package with all the necessary components. The system is normally filled with liquid, vented, adjusted and performance-tested prior to delivery, but can also be ordered in unfilled condition e.g. for housing improvement projects or if the application requires filling with another mixture instead of 30 % ethylene glycol. On the size 100/120 GOLD CX one-piece unit, the pipework package (accessory) including separate control unit are supplied in unmounted condition. Droplet eliminators are available as accessories.

Coil heat exchangers, droplet eliminators and pipework packages are available as unmounted accessories for the separate size 014-120 supply air and extract air handling units (SD) A separate control unit for the coil heat exchanger is always included in the supply.

The pipework package's valve variably regulates the coil heat exchanger's efficiency on heat recovery and the circulation pump is demand-controlled.

In cold weather, and if the extract air is humid, there is risk of frosting in coil heat exchangers. The GOLD CX/SD is equipped with an extremely effective anti-frost protection that measures the temperature of the liquid in the extract air coil and also the humidity in the extract air.

Taking the humidity into consideration, the IQlogic control system calculates the lowest permissible liquid temperature without risk of frosting inside the coil. The valve in the pipework package is then controlled to prevent the temperature from dropping below this limit.



Description of the Air Handling Unit

Mechanical Design

Duct Connections

Are for sizes 004/005, 007/008 and 011/012 circular and designed for connection to ducts with insertion joints fitted with a rubber seal ring. A duct bend fits directly into the connection. The duct connections are horizontally and vertically offset to enable ducts to be run in any direction without blocking one another. The size 004/005, 008 and 012 units are also available in a top-fed variant, the GOLD RX Top, with all the duct connections upward.

The size 014-120 units have rectangular duct connections with a securely mounted connection frame for slip-clamp joint connection. Type METU connection frames are available as an accessories.

To further reduce pressure losses, a full face end connection with larger rectangular duct connection is also offered as an accessory (all sizes).

The air handling unit's GOLD Wing+ fans provide a uniform airflow immediately downstream of the outlet making it possible to connect duct bends and functional sections, for example cooling coils, directly to the unit without appreciable pressure losses.

If insulated duct accessories are selected, they should be docked directly against the air handling unit. The air handling unit is then supplied without end connection panel for the relevant inlet/outlet.

Pressure Adjusting Plates (applicable to air handling units with rotary heat exchanger only)

The unit is equipped with pressure adjusting plates to ensure that the purging air flow through the heat exchanger will be as it was designed to be. These plates make it possible to achieve correct pressure balance in the unit so that the purging airflow will pass in the correct direction.

The pressure adjusting plates are supplied in unmounted condition and shall be positioned by the extract air inlet of the air handling unit.

Environment Declaration

Swegon AB has a certificated environmental management system that conforms to ISO 14001 Standard and is registered on the REPA Register, no. 5560778465.

A Building Material Declaration with a complete list of constituent materials is available on Swegon's home page.



Circular duct connections



*Circular duct connections
GOLD RX Top*



Rectangular duct connections

Description of the Air Handling Unit

Electrical and Control Equipment

General

The electrical and control system is completely integrated into the air handling unit. The microprocessor-based equipment controls and regulates temperatures, airflows and other functions. A large number of functions are built into the system and are simple to activate.

The air handling unit can be automatically controlled in several ways via the built-in timer or main control system, however it can also be demand-controlled e.g. via a CO₂ sensor. Manual control is also possible.

A large number of functions and settings can be activated/entered via a main control system.

Control Inaccuracy:

Temperature $\pm 1^{\circ}\text{C}$.

Airflow $\pm 5\%$.

Power Efficiency

The design and performance of the air handling unit are optimized for achieving excellent power efficiency.

Standards

The unit meets the provisions of the ELSÄK-FS 1999:5 and SS-EN 60204-1 electrical safety standards. Protection class IP 54.

Interference Level

The unit meets the requirements defined in the EMC Directive and has been tested according to the provisions in EN 61000-6-2 and 61000-6-3 (electromagnetic emissions in dwellings, office buildings, shops and similar environments as well as for immunity in industrial environments).

Use of an earth fault circuit breaker

The earth fault circuit breaker, if required, should only serve the air handling unit and must be of a type designed for use with the control system of the EC motor.

Control Unit – GOLD SD

If both GOLD SD supply air and extract air handling units are used in a ventilation system, the supply air unit is fitted with a control unit and the extract air unit is without. A communication cable is used to connect them to one another making it possible to control both units.

Electrical and Control Equipment

On the smaller unit sizes, the electrical and control equipment must be connected via the junction hood.

Connection cables for hand-held micro terminal, supply air temperature sensor, air heater and air cooler have modular connectors.

Other accessories and external functions can be connected to an easy-to-access row of terminal connections.



All electrical and control equipment is collected inside a special enclosure in the centred section of the air handling unit.

An extra terminal for a single phase 230 V supply is also provided after the safety switch on the GOLD unit. This terminal can be used for external functional sections and can be loaded with max. 1.5 A.

The extra functional sections such as a cooling unit and an electric air heater, must have a separate power supply.

GOLD RX/PX/CX

On the size 004-020 GOLD RX and the GOLD PX units, electrical and control equipment must be wired via the junction hood. On the size 025-070 and 080 GOLD RX and the size 035-080 GOLD CX units, electrical and control equipment must be wired via the panel on the centre section of the air handling unit. On the size 080 GOLD RX, capacity variant 2, and the size 100/120 GOLD CX units, electric power is connected across an external safety switch and the electrical and control equipment must be wired via the panel on the centre section of the air handling unit.

GOLD SD

On the size 004-080 GOLD DS units, the electrical and control equipment must be wired via the panel by the fan inspection door. On the size 100/120 units, electric power is connected across an external safety switch and the electrical and control equipment must be wired via the panel on the centre section of the air handling unit.

Description of the Air Handling Unit

Hand-held micro terminal IQnavigator and image management

The IQnavigator hand-held micro terminal, has 7" touch-screens and is very simple and user friendly. Commissioning and the entering of settings can be carried out intuitively and in steps. Flow images and help texts are always at hand.

The hand-held terminal is equipped with a three metre long connection cable that can be connected via quick-fit connector to the air handling unit's control unit (standard). Wireless communication between the hand-held terminal and the GOLD unit can also take place via WLAN (requires the IQnavigator hand-held terminal accessory with WLAN).

Communication between the hand-held micro terminal and the GOLD air handling unit can also transpire wirelessly via WLAN (accessory). It is just as simple to use a computer, tablet pc or cell phone via WiFi. Double Ethernet ports and USB connection are available as standard.

The preset values are stored and will not be unaffected in the event of a power failure.



Description of the Air Handling Unit

Control Schedule

Diagrammatic description of the control functions, GOLD RX

The built-in control system controls and regulates temperatures, airflows, in-operation periods and a large number of internal and external functions.

In that it is a microprocessor-based system, it can solve highly complicated tasks. The specific components are outlined below individually in a simplified and schematic specification.

When you use the AHU Design air handling unit selection program for calculating data, you receive a project-specific flow chart with complete description of pertinent unit functions.

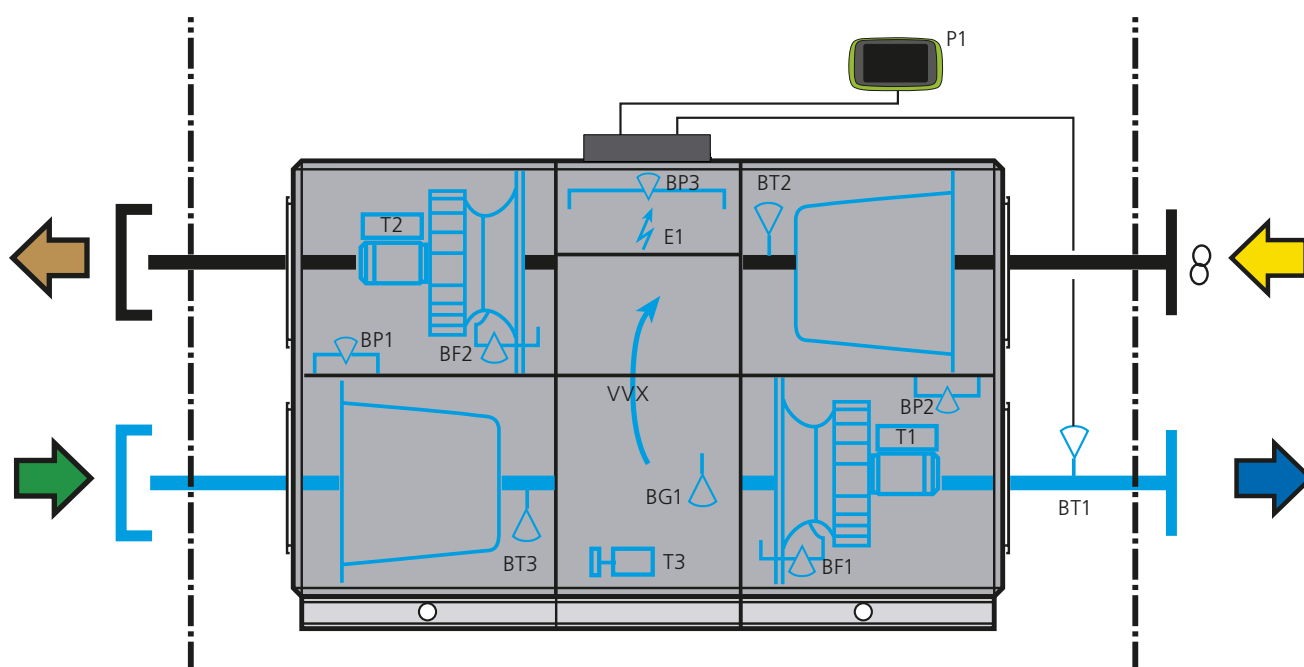

BT3	Temperature sensor, outdoor air.	BG1	Rotation monitor for checking the rotation of the heat exchanger.
BT1	Temperature sensor, supply air. Positioned in the ductwork	E1	Electrical equipment cubicle containing the control circuit card and other electrical equipment for controlling internal and external functions, etc.
BT2	Temperature sensor, extract air.	P1	Hand-held micro terminal for setting airflows, temperatures, control functions, in-operation periods, etc. as well as alarms.
T1/T2	Motor control system for variable speed control of the fan motors.	VVX	Variable speed-controlled rotary heat exchanger with air purging operation.
BF1/BF2	Pressure transducer. Indicates for controlling the fan speed so that the preset airflow will be maintained.	T3	Drive motor for the rotary heat exchanger
BP1/BP2	Pressure transducer for checking the filter status.		
BP3	Pressure sensor for checking the heat exchanger.		

Description of the Air Handling Unit

Control Schedule

Diagrammatic description of the control functions, GOLD PX

The built-in control system controls and regulates temperatures, airflows, in-operation periods and a large number of internal and external functions.

In that it is a microprocessor-based system, it can solve highly complicated tasks. The specific components are outlined below each individually in a simplified and schematic specification.

When you use the AHU Design air handling unit selection program for calculating data, you receive a project-specific flow chart with complete description of pertinent unit functions.

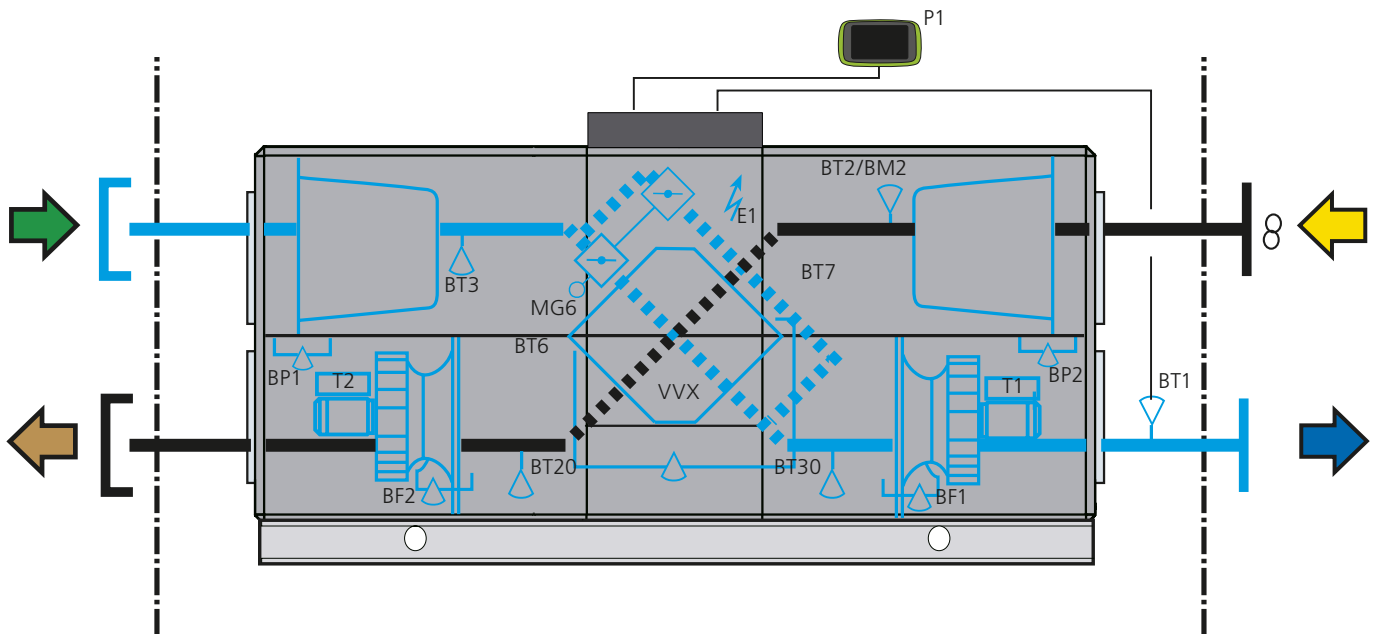

BT3	Temperature sensor, outdoor air.	MG6	Actuator for by-pass and shut-off dampers.
BT1	Temperature sensor, supply air. Positioned in the ductwork	E1	Electrical equipment cubicle containing the control circuit card and other electrical equipment for controlling internal and external functions, etc.
BT2/BM2	Extract air temperature sensor/Extract air humidity sensor. For RECO Frost anti-frost protection.	P1	Hand-held micro terminal for setting airflows, temperatures, control functions, in-operation periods, etc. as well as alarms.
T1/T2	Motor control system for variable speed control of the fan motors.	VVX	Counterflow heat exchanger with bypass and shut-off dampers.
BF1/BF2	Pressure transducer. Indicates for controlling the fan speed so that the preset airflow will be maintained.	BT20/BT30	Temperature sensor for density-corrected airflow.
BP1/BP2	Pressure transducer for checking the filter status.		
BT6	Heat exchanger pressure sensor. For anti-frost protection.		

Description of the Air Handling Unit

Control Schedule

Diagrammatic description of the control functions, GOLD CX

The built-in control system controls and regulates temperatures, airflows, in-operation periods and a large number of internal and external functions.

In that it is a microprocessor-based system, it can solve highly complicated tasks. The specific components are outlined below each individually in a simplified and schematic specification.

When you use the AHU Design air handling unit selection program for calculating data, you receive a project-specific flow chart with complete description of pertinent unit functions.

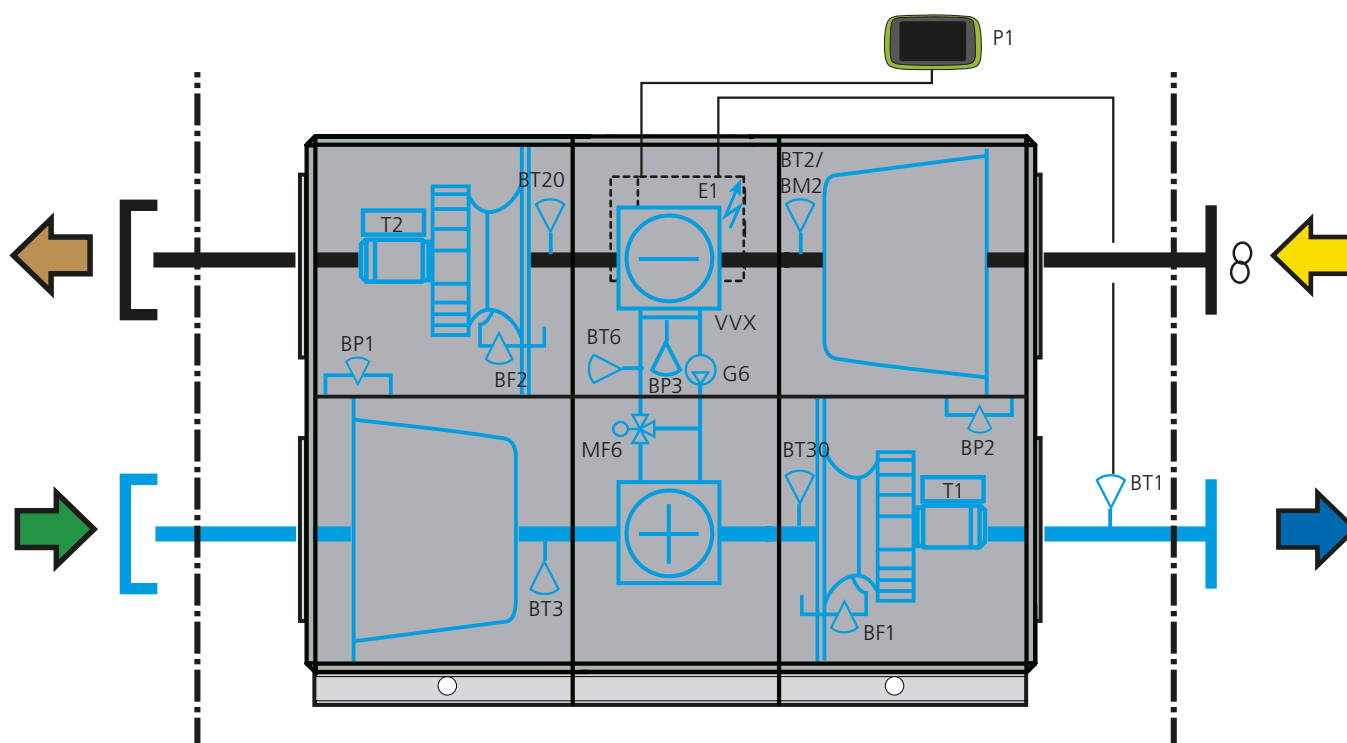

BT3	Temperature sensor, outdoor air.	G6	Circulation pump, coil heat exchangers.
BT1	Temperature sensor, supply air. Positioned in the ductwork.	MF6	Valve actuator, coil heat exchangers.
BT2/BM2	Temperature sensor, extract air/Humidity sensor, extract air. For anti-frost protection.	E1	Electrical equipment cubicle containing the control circuit card and other electrical equipment for controlling internal and external functions, etc.
T1/T2	Motor control system for variable speed control of the fan motors.	P1	Hand-held micro terminal for setting airflows, temperatures, control functions, in-operation periods, etc. as well as alarms.
BF1/BF2	Pressure transducer. Indicates for controlling the fan speed so that the preset airflow will be maintained.	VVX	Coil heat exchanger with pipework package.
BP1/BP2	Pressure transducer for checking the filter status.	BT20/BT30	Temperature sensor for density-corrected airflow.
BT6	Temperature sensor, coil heat exchangers. For anti-frost protection.	BP3	Differential pressure sensor.

GOLD CX, sizes 100/120: Pipework package including control box are supplied in unmounted condition for floor or wall mounting (accessories).

Description of the air handling unit

Control Schedule

Diagrammatic description of the control functions, GOLD SD, sizes 004-008

The built-in control system controls and regulates temperatures, airflows, in-operation periods and a large number of internal and external functions.

Because the system is microprocessor-based, it can solve highly complicated tasks. The individual components each specified below in a simplified and diagrammatical description.

When you use the AHU Design AHU selection program for calculating performance data, it provides you with a project-specific flow chart with complete descriptions of pertinent functions.

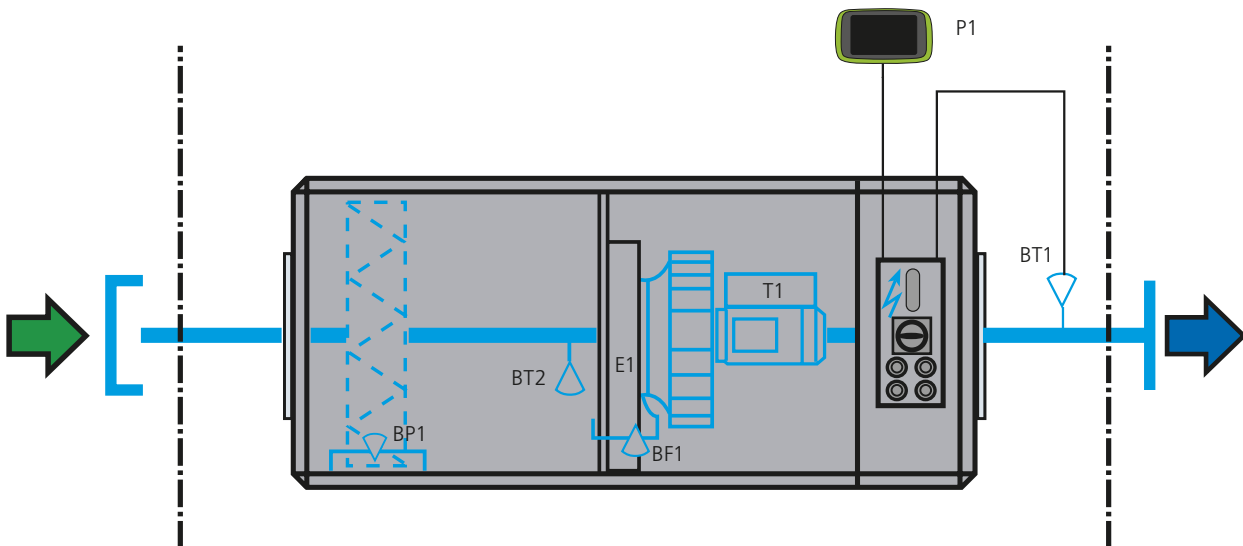

- | | |
|------------------------------------------------------------------------------------------------------------------------------------------------------------------------------------------------------------------------------------------------------------------------------------------------------------------------------------------------------------------------------------------------------------------------------------------------------------------------------------------------------------------------------------------------------------------------------------------------------------------------------------------------|----------------------------------------------------------------------------------------------------------------------------------------------------------------------------------------------------------------------------------------------------------------------------------------------------------------------------------------------------------------------------------------------------------------|
| <p>BT2 Outdoor air temperature sensor/supply air density sensor (In extract air handling units: Extract air temperature sensor/density sensor in exhaust air)</p> <p>BT1 Supply air temperature sensor. Positioned in the ductwork. (Not used in extract air units)</p> <p>BF1 Supply air fan pressure sensor. Indicates for control of the fan speed so that the preset airflow will be obtained. (In extract air handling units: Extract air fan pressure sensor)</p> <p>BP1 Supply air filter pressure sensor, if applicable. For checking the status of the filter (In extract air handling units: Extract air filter pressure sensor)</p> | <p>T1 Motor control system for variable speed control of the fan motor.</p> <p>E1 Electrical equipment cubicle containing a control circuit card, if included, and other electrical equipment for controlling internal and external functions, etc.</p> <p>P1 Hand-held micro terminal, if specified, for setting airflows, temperatures, control functions, in-operation periods, etc. as well as alarms.</p> |
|------------------------------------------------------------------------------------------------------------------------------------------------------------------------------------------------------------------------------------------------------------------------------------------------------------------------------------------------------------------------------------------------------------------------------------------------------------------------------------------------------------------------------------------------------------------------------------------------------------------------------------------------|----------------------------------------------------------------------------------------------------------------------------------------------------------------------------------------------------------------------------------------------------------------------------------------------------------------------------------------------------------------------------------------------------------------|

Description of the air handling unit

Control Schedule

Diagrammatic description of the control functions, GOLD SD, sizes 012

The built-in control system controls and regulates temperatures, airflows, in-operation periods and a large number of internal and external functions.

Because the system is microprocessor-based, it can solve highly complicated tasks. The individual components each specified below in a simplified and diagrammatical description.

When you use the AHU Design AHU selection program for calculating performance data, it provides you with a project-specific flow chart with complete descriptions of pertinent functions.

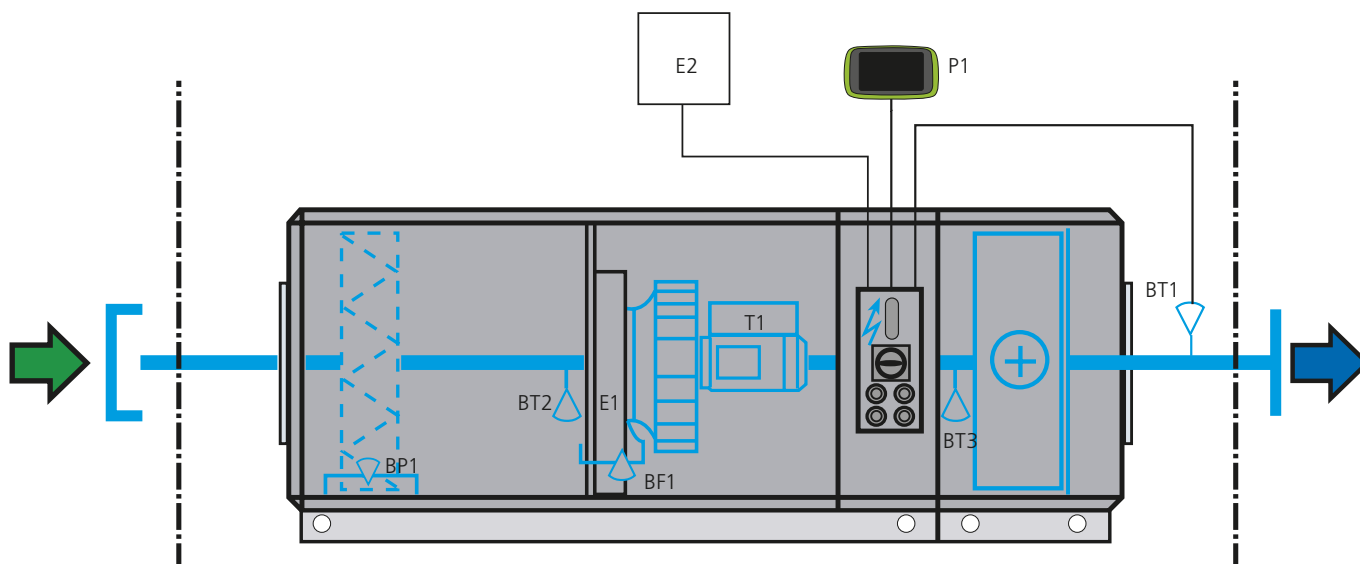

BT3	Outdoor air temperature sensor. (Applicable to air handling units with coil heat exchanger)	T1	Motor control system for variable speed control of the fan motor.
BT2	Outdoor air temperature sensor/supply air density sensor (In extract air units: Extract air temperature sensor/exhaust air density sensor)	E1	Electrical equipment cubicle containing a control circuit card, if included, and other electrical equipment for controlling internal and external functions, etc.
BT1	Supply air temperature sensor. Positioned in the ductwork. (Not used in extract air units)	E2	Control unit, if applicable, for controlling the pipework package.
BF1	Supply air fan pressure sensor. Indicates for control of the fan speed so that the preset airflow will be obtained. (In extract air handling units: Extract air fan pressure sensor)	P1	Hand-held micro terminal, if specified, for setting airflows, temperatures, control functions, in-operation periods, etc. as well as alarms.
BP1	Supply air filter pressure sensor, if applicable. For checking the status of the filter (In extract air handling units: Extract air filter pressure sensor)		

Description of the air handling unit

Control Schedule

Diagrammatic description of the control functions, GOLD SD, sizes 004-120

The built-in control system controls and regulates temperatures, airflows, in-operation periods and a large number of internal and external functions.

Because the system is microprocessor-based, it can solve highly complicated tasks. The individual components each specified below in a simplified and diagrammatical description.

When you use the AHU Design AHU selection program for calculating performance data, it provides you with a project-specific flow chart with complete descriptions of pertinent functions.

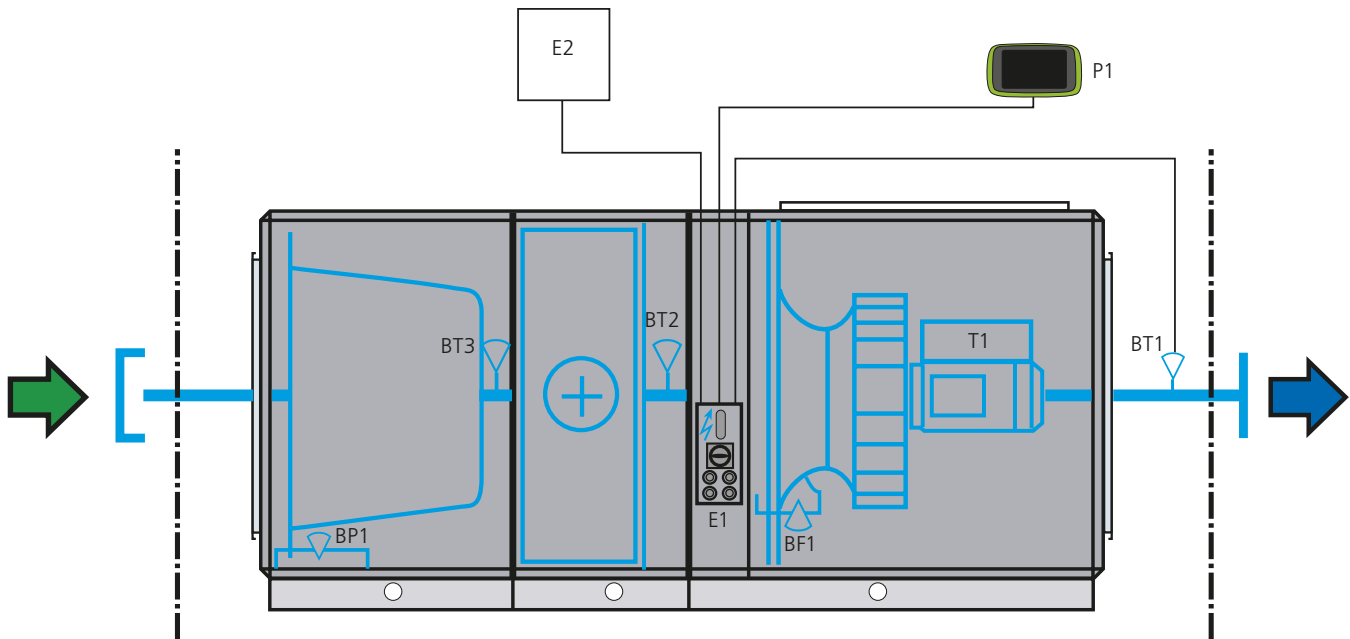

- | | |
|------------------------------------------------------------------------------------------------------------------------------------------------------------------------------------------------------------------------------------------------------------------------------------------------------------------------------------------------------------------------------------------------------------------------------------------------------------------------------------------------------------------------------------------------------------------------------------------------------------------------------------------------------------------------------------------------------------------------------------------------------------------------------|-------------------------------------------------------------------------------------------------------------------------------------------------------------------------------------------------------------------------------------------------------------------------------------------------------------------------------------------------------------------------------------------------------------------------------------------------------------------------------------------------------------------------|
| <p>BT3 Outdoor air temperature sensor. (Applicable to air handling units with coil heat exchanger)</p> <p>BT2 Outdoor air temperature sensor/supply air density sensor (In extract air units: Extract air temperature sensor/exhaust air density sensor)</p> <p>BT1 Supply air temperature sensor. Positioned in the ductwork. (Not used in extract air units)</p> <p>BF1 Supply air fan pressure sensor. Indicates for control of the fan speed so that the preset airflow will be obtained. (In extract air handling units: Extract air fan pressure sensor)</p> <p>BP1 Supply air filter pressure sensor, if applicable. For checking the status of the filter (In extract air handling units: Extract air filter pressure sensor)</p> | <p>T1 Motor control system for variable speed control of the fan motor.</p> <p>E1 Electrical equipment cubicle containing a control circuit card, if included, and other electrical equipment for controlling internal and external functions, etc.</p> <p>E2 Control unit, if applicable, for controlling the pipework package.</p> <p>P1 Hand-held micro terminal, if specified, for setting airflows, temperatures, control functions, in-operation periods, etc. as well as alarms.</p> |
|------------------------------------------------------------------------------------------------------------------------------------------------------------------------------------------------------------------------------------------------------------------------------------------------------------------------------------------------------------------------------------------------------------------------------------------------------------------------------------------------------------------------------------------------------------------------------------------------------------------------------------------------------------------------------------------------------------------------------------------------------------------------------|-------------------------------------------------------------------------------------------------------------------------------------------------------------------------------------------------------------------------------------------------------------------------------------------------------------------------------------------------------------------------------------------------------------------------------------------------------------------------------------------------------------------------|

Description of the air handling unit

Delivery Version

RX/PX/CX, sizes 004-080

The GOLD RX/PX/CX units are composed of unit sections.

The unit sections are as follows:

- Fan/filter section
- Heat exchanger section (RX, PX, CX and RX/HC respectively)
- Air recirculation section
- Air bypass section
- Multisection
- Duct crossover section (PX)

The basic arrangement of the GOLD RX/PX/CX units consists of two fan/filter sections and one heat exchanger section. The other air handling unit sections are optional, see also the section entitled Complements and Accessories.

The unit sections in an air handling unit arrangement can be selected for delivery as separate or already fitted together with one or several other unit sections, however with restrictions specified below:

- The fan/filter section with the fan in the upper section is always supplied already fitted together with another unit section.
- The heat exchanger section, RX and CX, is always supplied already fitted together with another unit section.
- The air recirculation, air bypass, multi and duct crossover sections are always supplied already fitted together with another unit section.
- The max. length of a delivery unit is 3,000 mm.
- An air handling unit arrangement may at most be divided into four delivery units (sizes 004-060).
- An air handling unit arrangement may at most consist of seven unit sections (sizes 004-060).
- The heat exchanger section, PX, is always supplied as one separate unit.

See also Swegon's air handling unit software: AHU Design.

Description of the Air Handling Unit

Installation Tips

Sizing the Duct System

The preset flow is automatically kept at a constant rate if this function has been selected in the hand-held micro terminal. Lower air velocity in ducts and air diffusers mean lower pressure drop and consequently lower energy consumption and a quieter ventilation system.

To achieve optimal operating economy and low noise level it is important to design the ventilation system with as low pressure drop as possible. The hoods for outdoor air and extract air, designed especially for the GOLD, are optimized in this respect.

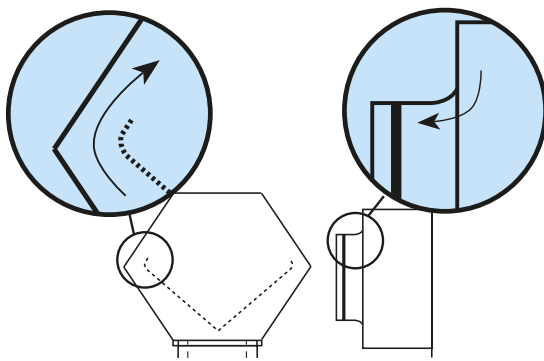

Examples of how air deflectors and extruded inlets minimize pressure losses in Swegon accessories for the GOLD.

A duct or non-return damper of its own.

Zero calibration is an integrated function in the GOLD air handling units. Every individual GOLD air handling unit in a ventilation system must be equipped with its own outdoor air and exhaust air hood/duct in order for this function to operate correctly. Or else, every individual air handling unit must be equipped with a non-return damper or a motorized damper in the outdoor air duct and/or exhaust air duct.

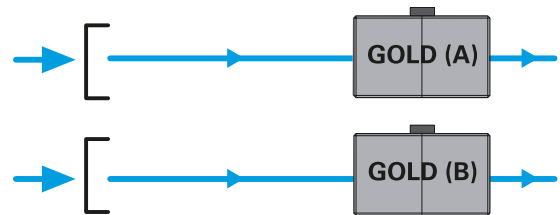

Every GOLD air handling unit must have its own outdoor air duct (and its own exhaust air duct/hood).

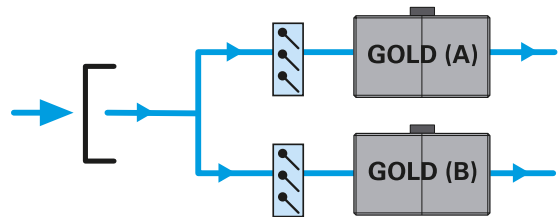

If the use of a common outdoor air duct is still desirable, every branch duct for each GOLD air handling unit must be equipped with a non-return damper or a motorized damper (also applies to a common exhaust air duct/hood).