

Fault tracing tripped alarm GOLD E			Document no.	Revision	Page
					1 (146)
			Date released	Supersedes	
Type of document	Drawn up by	Revised by	Released and published by		
Instruktion	Bertil Sjunnesson	Magnus Hallén			

Instructions for troubleshooting tripped alarms in the GOLD Version E.

Contents

1.	General	6
1.1	Authorisation	6
2.	Tripped alarms	7
2.1.	Alarm group 1: FIRE ALARMS	7
2.1.1.	Alarm no. 1:1 – 1:2 "External fire alarm no. 1/2 tripped"	7
2.1.2.	Alarm no. 1:3 "Internal fire alarm tripped"	8
2.2.	Alarm group 2: EXTERNAL ALARMS	9
2.2.1.	Alarm no. 2:1 – 2:2 "External alarm no. 1/2 tripped"	9
2.3.	Alarm group 3: PRE-HEAT ALARMS	10
2.3.1.	Alarm no. 3:1 "Pre-heat, I/O module no. 9 communication error"	10
2.3.2.	Alarm no. 3:2 "Pre-heat, overheated electric air heater tripped"	12
2.3.3.	Alarm no. 3:3 "Pre-heat, frost guard alarm tripped"	14
2.3.4.	Alarm no. 3:4 "Pre-heat, frost guard sensor defective"	16
2.3.5.	Alarm no. 3:5 "Pre-heat, frost guard sensor defective"	16
2.3.6.	Alarm no. 3:6 "Pre-heat, valve monitoring tripped"	17
2.3.7.	Alarm no. 3:7 "Pre-heat, temperature below set point"	21
2.3.8.	Alarm no. 3:8 "Pre-heat, alarm input tripped"	22
2.4.	Alarm group 4: EXTRA REGULATION SEQUENCE	23
2.4.1.	Alarm no. 4:1 "Extra regulation sequence, module no. E communication error"	23
2.4.2.	Alarm no. 4:2 "Extra regulation sequence, overheat, electric air heater tripped"	23
2.4.3.	Alarm no. 4:3 "Extra regulation sequence, frost guard alarm tripped"	23
2.4.4.	Alarm no. 4:4 "Extra regulation sequence, frost guard sensor defective"	23
2.4.5.	Alarm no. 4:5 "Extra regulation sequence, valve monitoring tripped"	23
2.4.6.	Alarm no. 4:6 "Extra regulation sequence 1, Alarm input tripped"	24
2.4.7.	Alarm no. 4:7 "Extra regulation sequence 1, temperature protection from communication error"	24
2.4.8.	Alarm no. 4:9 "Extra regulation sequence 2, Communication error I/O module no. F"	24
2.4.9.	Alarm no. 4:10 "Extra regulation sequence 2, electrical heater over heat protection tripped"	24
2.4.10.	Alarm no. 4:11 "Extra regulation sequence 2, Frost protection tripped"	24
2.4.11.	Alarm no. 4:12 "Extra regulation sequence 2, Frost protection temperature sensor defective"	24
2.4.12.	Alarm no. 4:13 "Extra regulation sequence 2, valve monitoring tripped"	25
2.4.13.	Alarm no. 4:14 "Extra regulation sequence 2, alarm input tripped"	25
2.5.	Alarm group 5: RE-HEAT	25
2.5.1.	Alarm no. 5:1 "Re-heat, overheated electric air heater tripped"	25
2.5.2.	Alarm no. 5:2 "Re-heat, frost guard alarm tripped"	25
2.5.3.	Alarm no. 5:3 "Re-heat, frost guard sensor defective"	25
2.5.4.	Alarm no. 5:4 "Re-heat, valve monitoring tripped"	26
2.6.	Alarm group 6: XZONE MODULE NO. A	27
2.6.1.	Alarm no. 6:1 "Xzone, I/O module no. A communication error"	27
2.6.2.	Alarm no. 6:2 "Xzone, overheat, electric air heater tripped"	27
2.6.3.	Alarm no. 6:3 "Xzone, frost guard alarm tripped"	27
2.6.4.	Alarm no. 6:4 "Xzone, frost protection temp. sensor defective"	27
2.6.5.	Alarm no. 6:5 "Xzone, SA temperature sensor defective"	27
2.6.6.	Alarm no. 6:6 "Xzone, heat valve monitoring tripped"	27

Fault tracing tripped alarm GOLD E			Document no.	Revision	Page
					2 (146)
			Date released	Supersedes	
Type of document	Drawn up by	Revised by	Released and published by		
Instruktion	Bertil Sjunnesson	Magnus Hallén			

2.6.7.	Alarm no. 6:7 "Xzone, SA temperature below set point"	28
2.6.8.	Alarm no. 6:8 "Xzone, SA temperature above set point"	30
2.6.9.	Alarm no. 6:9 "Xzone, heat alarm input tripped"	31
2.7.	Alarm group 7: XZONE MODULE NO. B	32
2.7.1.	Alarm 7:1 "Xzone, I/O module no. B communication error"	32
2.7.2.	Alarm no. 7:2 "Xzone, EA temperature sensor defective"	32
2.7.3.	Alarm no. 7:3 "Xzone, cool valve monitoring tripped"	32
2.7.4.	Alarm no. 7:4 "Xzone, EA temperature below set point"	32
2.7.5.	Alarm no. 7:5 "Xzone, cool alarm input 1 tripped"	32
2.7.6.	Alarm no. 7:6 "Xzone, cool alarm input 2 tripped"	32
2.8.	Alarm group 8: COOLING	33
2.8.1.	Alarm no. 8:5 "Cool, valve monitoring tripped"	33
2.9.	Alarm group 10: AHU TEMPERATURE SENSOR	34
2.9.1.	Alarm no. 10:1 "Supply air temperature sensor defective"	34
2.9.2.	Alarm no. 10:2 "Supply air temperature sensor for density compensation defective"	35
2.9.3.	Alarm no. 10:3 "Extract air temperature sensor defective"	36
2.9.4.	Alarm no. 10:4 "Extract air temperature sensor for density compensation defective"	37
2.9.5.	Alarm no. 10:5 "Extract air temperature sensor for defrost defective"	37
2.9.6.	Alarm no. 10:6 "Extract air temperature sensor for density compensation in SD AHU defective"	38
2.9.7.	Alarm no. 10:7 "Extract air duct temperature sensor defective"	38
2.9.8.	Alarm no. 10:10 "Outdoor temperature sensor defective"	38
2.10.	Alarm group 11: AHU MIN/MAX/MEDIUM TEMPERATURE SENSORS	39
2.10.1.	Alarm no. 11:1-4 "Room temperature sensors nos. 1 – 4 defective"	39
2.10.2.	Alarm no. 11:5-8 "Xzone, room temperature sensors nos. 5 - 8 defective"	40
2.10.3.	Alarm nos. 11:9 – 12 "Outdoor temperature sensors A – D defective"	40
2.10.4.	Alarm no. 11:13 "Room temperature via communication, communication error"	40
2.10.5.	Alarm no. 11:14 "Xzone, room temperature via communication, communication error"	40
2.10.6.	Alarm no 11:15 "Outdoor temperature via communication, communication error"	40
2.11.	Alarm group 12: AHU TEMPERATURE DEVIATION	41
2.11.1.	Alarm no. 12:1 "Supply air temperature below set point"	41
2.11.2.	Alarm no. 12:2 "Supply air temperature above set point"	41
2.11.3.	Alarm no. 12:6 "Extract air temperature below alarm limit"	41
2.11.4.	Alarm no. 12:11 "Temperature monitor below alarm limit"	41
2.12.	Alarm group 13: HUMIDITY / VOC	41
2.12.1.	Alarm no. 13:1 "Humidification, I/O module no. 4 communication error"	41
2.12.2.	Alarm no. 13:12 "VOC sensor internal communication error"	42
2.12.3.	Alarm no. 13:13 "VOC sensor, internal error"	42
2.12.4.	Alarm no. 13:14 "VOC sensor, level below/above set point alarm limit"	42
2.12.5.	Alarm no. 13:2 "Supply air humidity sensor defective"	42
2.12.6.	Alarm no. 13:3 "Extract air humidity sensor defective"	43
2.12.7.	Alarm no. 13:9 "Humidifier, alarm output tripped"	43
2.12.8.	Alarm no. 13:11 "VOC sensor communication error"	44
2.12.9.	Alarm no. 13:12 "VOC sensor defective"	44
2.13.	Alarm group 15: PLATE HEAT EXCHANGER	45
2.13.1.	Alarm no. 15:1 "Plate heat exchanger, I/O module no. 2 communication error"	45
2.13.2.	Alarm no. 15:2-3 "Plate heat exchanger temp. sensor no. 1-2 defective"	47
2.13.3.	Alarm no. 15:4 "Plate heat exchanger, damper monitoring tripped"	48
2.13.4.	Alarm no. 15:7 "Plate heat exchanger, I/O module no. 3 communication error"	51
2.13.5.	Alarm no. 15:8 "Plate heat exchanger, Bypass damper monitoring tripped"	51
2.13.6.	Alarm no. 15:9 "Plate heat exchanger, Damper no. 1 monitoring tripped"	51
2.13.7.	Alarm no. 15:10 "Plate heat exchanger, Damper no. 2 monitoring tripped"	51

Fault tracing tripped alarm GOLD E			Document no.	Revision	Page
					3 (146)
			Date released	Supersedes	
Type of document	Drawn up by	Revised by	Released and published by		
Instruktion	Bertil Sjunnesson	Magnus Hallén			

2.13.8.	Alarm no. 15:11 "Plate heat exchanger, I/O module no. 3 communication error"	51
2.13.9.	Alarm no. 15:12 "Plate heat exchanger, Bypass damper monitoring tripped"	52
2.13.10.	Alarm no. 15:14 "Plate heat exchanger, defrost pressure sensor no. C communication error"	53
2.13.11.	Alarm no. 15:15 "Plate heat exchanger, defrost pressure above alarm limit"	55
Alarm group 16: COIL HEAT EXCHANGER		55
2.13.12.	Alarm no. 16:1 "Coil heat exchanger, I/O module no. 1 communication error"	55
2.13.13.	Alarm no. 16:2 "Coil heat exchanger, temperature sensor defective"	55
2.13.14.	Alarm no. 16:3 "Coil heat exchanger, valve monitoring tripped"	57
2.13.15.	Alarm no. 16:4 "Coil heat exchanger, pump monitoring tripped"	57
2.14.	Alarm group 17: ROTARY HEAT EXCHANGER	58
2.14.1.	Alarm no. 17:1 "Rotary heat exchanger, communication error, motor controller"	58
2.14.2.	Alarm 17:2 "Rotary heat exchanger, communication error, pressure sensor 7 defrost"	62
2.14.3.	Alarm no. 17:3 "Rotary heat exchanger, defrost pressure above alarm limit"	64
2.14.4.	Alarm no. 17:4 "Rotary heat exchanger, rotation monitor tripped"	65
2.14.5.	Alarm no. 17:5 "Rotary heat exchanger, over current to HX control system"	70
2.14.6.	Alarm no. 17:6 "Rotary heat exchanger, undercurrent to HX control system"	71
2.14.7.	Alarm no. 17:7 "Rotary heat exchanger, over voltage to HX control system"	72
2.14.8.	Alarm no. 17:8 "Rotary heat exchanger, over temperature to HX control system"	72
2.14.9.	Alarm no. 17:9 "Rotary heat exchanger, HX control system start error"	74
2.15.	Alarm group 18: AYC	75
2.15.1.	Alarm no. 18:1 "AYC, I/O module no. 7 communication error"	75
2.15.2.	Alarm no. 18:2 "AYC Heat, temperature sensor defective"	76
2.15.3.	Alarm no. 18:3 "AYC Heat, pump monitoring tripped"	77
2.15.4.	Alarm no. 18:4 "AYC heat, pump monitoring tripped"	79
2.15.5.	Alarm no. 18:5 "AYC Heat, below set point alarm limit"	80
2.15.6.	Alarm no. 18:6 "AYC Heat, above set point alarm limit"	81
2.15.7.	Alarm no. 18:9 "AYC Cool, temperature sensor defective"	82
2.15.8.	Alarm no. 18:10 "AYC Cool, valve monitoring tripped"	83
2.15.9.	Alarm no. 18:11 "AYC Cool, pump monitoring tripped"	85
2.15.10.	Alarm 18:12 "AYC Cool, below set point alarm limit"	86
2.15.11.	Alarm no. 18:13 "AYC Heat, above set point alarm limit"	87
2.16.	Alarm group 21: COOL DX	87
2.16.1.	Alarm no. 21:1 "COOL DX, I/O module no. 2 communication error"	87
2.16.2.	Alarm no. 21:2 "COOL DX, compressor 1, low pressure sensor defective"	90
2.16.3.	Alarm no. 21:3 "COOL DX, compressor 1, low pressure sensor below alarm limit"	91
2.16.4.	Alarm no. 21:4 "COOL DX, compressor 1, high pressure sensor defective"	92
2.16.5.	Alarm no. 21:5 "COOL DX, compressor 1, high pressure sensor above alarm limit"	92
2.16.6.	Alarm no. 21:6 "COOL DX, compressor 1, monitoring tripped"	93
2.16.7.	Alarm no. 21:7 "COOL DX, compressor 1, restart error"	95
2.16.8.	Alarm no. 21:8 "COOL DX, compressor 2, low pressure sensor defective"	96
2.16.9.	Alarm no. 21:9 "COOL DX, compressor 2, low pressure sensor below alarm limit"	96
2.16.10.	Alarm no. 21:10 "COOL DX, compressor 2, high pressure sensor defective"	96
2.16.11.	Alarm no. 21:11 "COOL DX, compressor 2, high pressure sensor above alarm limit"	96
2.16.12.	Alarm no. 21:12 "COOL DX, compressor 2, monitoring tripped"	96
2.16.13.	Alarm no. 21:13 "COOL DX, compressor 2, restart error"	96
2.16.14.	Alarm no. 21:14 "COOL DX, outdoor temperature sensor defective"	97
2.16.15.	Alarm no. 21:15 "COOL DX, phase sequence monitor tripped"	97
2.17.	Alarm group 23: SMART LINK	98
2.17.1.	Alarm 23:1 "SMART Link, communication error"	98
2.17.2.	Alarm no. 23:2-4 "SMART Link, alarm levels 1-3 tripped"	100
2.17.3.	Alarm no. 23:10 "AQUA Link, I/O module no. 5 communication error"	100

Fault tracing tripped alarm GOLD E			Document no.	Revision	Page
					4 (146)
			Date released	Supersedes	
Type of document	Drawn up by	Revised by	Released and published by		
Instruktion	Bertil Sjunnesson	Magnus Hallén			

2.17.4.	Alarm no. 23:10 "AQUA Link, I/O module no. 5 communication error"	100
2.17.5.	Alarm no. 23:11 "AQUA Link, pump monitoring tripped"	100
2.18.	Alarm group 24: SMART LINK, DX	101
2.18.1.	Alarm no. 24:1 "SMART Link, no. 1 communication error"	101
2.18.2.	Alarm no. 24:2 "SMART Link, no. 1 tripped"	101
2.18.3.	Alarm no. 24:4 "SMART Link, no. 2 communication error"	102
2.18.4.	Alarm no. 24:5 "SMART Link, no. 2 tripped"	102
2.18.5.	Alarm no. 24:7 "SMART Link, no. 3 communication error"	102
2.18.6.	Alarm no. 24:8 "SMART Link, no. 3 tripped"	102
2.18.7.	Alarm no. 24:10 "SMART Link, no. 4 communication error"	102
2.18.8.	Alarm no. 24:8 "SMART Link, no. 4 tripped"	102
2.19.	Alarm group 26: PRE-FILTERS	103
2.19.1.	Alarm no. 26:1 "Pre-filter, supply air pressure sensor no. 8 communication error"	103
2.19.2.	Alarm no. 26:2 "Pre-filter, supply air, dirty"	105
2.19.3.	Alarm no. 26:7 "Pre-filter, extract air pressure sensor no. 9 communication error"	107
2.19.4.	Alarm no. 26:8 "Pre-filter, extract air, dirty"	107
2.20.	Alarm group 27: AIR HANDLING UNIT FILTERS	108
2.20.1.	Alarm no. 27:1 "Air handling unit filter, supply air pressure sensor no. 3/4, communication error"	108
2.20.2.	Alarm no. 27:2 "Air handling unit filter, supply air, dirty"	108
2.20.3.	Alarm no. 27:7 "Air handling unit filter, extract air pressure sensor no. 3/4, communication error"	108
2.20.4.	Alarm no. 27:8 "Air handling unit filter, extract air, dirty"	108
2.21.	Alarm group 28: END FILTERS	109
2.21.1.	Alarm no. 28:1 "End filter, supply air pressure sensor no. A communication error"	109
2.21.2.	Alarm no. 28:2 "End filter, supply air, dirty"	110
2.22.	Alarm group 30: FLOW MEASUREMENT	110
2.22.1.	Alarm no. 30:1 "Flow measurement, supply air pressure sensor no. 1/2, communication error"	110
2.22.2.	Alarm no. 30:2 "Flow measurement, supply airflow below set point"	111
2.22.3.	Alarm no. 30:3 "Flow measurement, supply airflow above set point"	113
2.22.4.	Alarm no. 30:6 "Flow measurement, extract air pressure sensor no. 1/2, communication error"	115
2.22.5.	Alarm no. 30:7 "Flow measurement, extract airflow below set point"	115
2.22.6.	Alarm no. 30:8 "Flow measurement, extract airflow above set point"	115
2.22.7.	Alarm no 30:11 "Flow measurement, carry over control, pressure sensor no. B communication error"	116
2.23.	Alarm group 31: PRESSURE REGULATION	116
2.23.1.	Alarm no. 31:1 "Pressure regulation, supply air pressure sensor no. 5 communication error"	116
2.23.2.	Alarm no. 31:2 "Pressure regulation, supply air pressure below set point"	116
2.23.3.	Alarm no. 31:3 "Pressure regulation, supply air pressure above set point"	119
2.23.4.	Alarm no. 31:6 "Pressure regulation, extract air pressure sensor no. 6 communication error"	122
2.23.5.	Alarm no. 31:7 "Pressure regulation, extract air pressure below set point"	122
2.23.6.	Alarm no. 31:8 "Pressure regulation, extract air pressure above set point"	122
2.24.	Alarm group 32: ReCO2	122
2.24.1.	Alarm no. 32:1 "ReCO2, I/O- module no. 0 communication error"	122
2.24.2.	Alarm no. 32:2 "ReCO2, supply air pressure sensor no. 0 communication error"	122
2.24.3.	Alarm no. 32:3 "ReCO2, recirculation damper monitoring tripped"	123
2.24.4.	Alarm no. 32:4 "ReCO2, outdoor air damper monitoring tripped"	123
2.25.	Alarm group 33: SERVICE	123

Fault tracing tripped alarm GOLD E			<i>Document no.</i>	<i>Revision</i>	<i>Page</i>
					5 (146)
			<i>Date released</i>	<i>Supersedes</i>	
<i>Type of document</i>	<i>Drawn up by</i>	<i>Revised by</i>	<i>Released and published by</i>		
Instruktion	Bertil Sjunnesson	Magnus Hallén			

2.25.1.	Alarm no. 33:1 "Service period over alarm limit"	123
2.25.2.	Alarm no. 33:15 "Lock function tripped"	123
2.26.	Alarm group 34: EXTERNAL CONTROLS.....	124
2.26.1.	Alarm no. 34:1 "External control, I/O module no. 3 communication error"	124
2.26.2.	Alarm no. 34:2 "External control, I/O module no. 6 communication error"	124
2.27.	Alarm group 35: BOOSTER AIR TERMINALS.....	124
2.27.1.	Alarm no. 35:1 "Booster air terminals, I/O module no. 8 communication error"	124
2.28.	Alarm groups 38 – 47: MIRU CONTROL NOS. 1 – 10.....	124
2.28.1.	Alarm nos. 38.1 – 47:1 "MIRU Control nos. 1 – 10, communication error"	125
2.28.2.	Alarm nos. 38.2 – 47:2 "MIRU Control nos. 1 – 10, fan motor controller tripped"	127
2.28.3.	Alarm nos. 38.3 – 47:3 "MIRU Control nos. 1 – 10, motor controller communication error"	127
2.28.4.	Alarm nos. 38.4 – 47:4 "MIRU Control nos. 1 – 10, flow pressure sensor no. 0 com. error"	127
2.28.5.	Alarm nos. 38.5 – 47:5 "MIRU Control nos. 1 – 10, duct pressure sensor no. 1 com. error"	127
2.28.6.	Alarm nos. 38.6 – 47:6 "MIRU Control nos. 1 – 10, temperature sensor defective"	127
2.28.7.	Alarm nos. 38.7 – 47:7 "MIRU Control nos. 1 – 10, flow/pressure deviates from set point"	128
2.29.	Alarm groups 49 – 51: SUPPLY AIR FAN nos. 1A, 2A and 3A.	129
2.29.1.	Alarm nos. 49.1 – 51:1 "Supply air fan nos. 1A – 3A, communication error"	129
2.29.2.	Alarm nos. 49.2 – 51:2 "Supply air fan nos. 1A – 3A over current"	132
2.29.3.	Alarm nos. 49.3 – 51:3 "Supply air fan nos. 1A – 3A under voltage"	133
2.29.4.	Alarm nos. 49.4 – 51:4 "Supply air fan nos. 1A – 3A over voltage"	134
2.29.5.	Alarm nos. 49.5 – 51:5 "Supply air fan nos. 1A – 3A over temperature"	134
2.29.6.	Alarm nos. 49.6 – 51:6 "Supply air fan nos. 1A – 3A fan motor blocked"	135
2.29.7.	Alarm nos. 49.7 – 51:7 "Supply air fan nos. 1A – 3A ripple error"	135
2.29.8.	Alarm nos. 49.8 – 51:8 "Supply air fan nos. 1A – 3A phase error"	135
2.29.9.	Alarm nos. 49.9 – 51:9 "Supply air fan nos. 1A – 3A EEprom error"	135
2.29.10.	Alarm nos. 49.10 – 51:10 "Supply air fan nos. 1A – 3A current limitation"	135
2.30.	Alarm groups 52 – 54: SUPPLY AIR FAN nos. 1B, 2B and 3B.	136
2.30.1.	Alarm nos. 52.1 – 54:1 "Supply air fan nos. 1B – 3B, communication error"	136
2.30.2.	Alarm nos. 52.2 – 54:2 "Supply air fan nos. 1B – 3B over current"	139
2.30.3.	Alarm nos. 52.3 – 54:3 "Supply air fan nos. 1B – 3B under voltage"	139
2.30.4.	Alarm nos. 52.4 – 54:4 "Supply air fan nos. 1B – 3B over voltage"	139
2.30.5.	Alarm nos. 52.5 – 54:5 "Supply air fan nos. 1B – 3B over temperature"	140
2.30.6.	Alarm nos. 52.6 – 54:6 "Supply air fan nos. 1B – 3B fan motor blocked"	140
2.30.7.	Alarm nos. 52.7 – 54:7 "Supply air fan nos. 1B – 3B ripple error"	140
2.30.8.	Alarm nos. 52.8 – 54:8 "Supply air fan nos. 1B – 3B phase error"	140
2.30.9.	Alarm nos. 52.9 – 54:9 "Supply air fan nos. 1B – 3B EEprom error"	141
2.30.10.	Alarm nos. 52.10 – 54:10 "Supply air fan nos. 1B – 3B current limitation"	141
2.31.	Alarm groups 55 – 57: EXTRACT AIR FAN no. 1A, 2A and 3A.	141
2.31.1.	Alarm nos. 55.1 – 57:1 "Extract air fan no. 1A – 3A, communication error"	141
2.31.2.	Alarm nos. 55.2 – 57:2 "Extract air fan no. 1A – 3A over current"	141
2.31.3.	Alarm nos. 55.3 – 57:3 "Extract air fan no. 1A – 3A under voltage"	141
2.31.4.	Alarm nos. 55.4 – 57:4 "Extract air fan no. 1A – 3A over voltage"	142
2.31.5.	Alarm nos. 55.5 – 57:5 "Extract air fan no. 1A – 3A over temperature"	142
2.31.6.	Alarm nos. 55.6 – 57:6 "Extract air fan no. 1A – 3A fan motor blocked"	142
2.31.7.	Alarm nos. 55.7 – 57:7 "Extract air fan no. 1A – 3A ripple error"	142
2.31.8.	Alarm nos. 55.8 – 57:8 "Extract air fan no. 1A – 3A phase error"	143
2.31.9.	Alarm nos. 55.9 – 57:9 "Extract air fan no. 1A – 3A EEprom error"	143
2.31.10.	Alarm nos. 55.10 – 57:10 "Extract air fan no. 1A – 3A current limitation"	143

Fault tracing tripped alarm GOLD E			<i>Document no.</i>	<i>Revision</i>	<i>Page</i>
					6 (146)
			<i>Date released</i>	<i>Supersedes</i>	
<i>Type of document</i>	<i>Drawn up by</i>	<i>Revised by</i>	<i>Released and published by</i>		
Instruktion	Bertil Sjunnesson	Magnus Hallén			

2.32.	Alarm groups 58 – 60: EXTRACT AIR FAN no. 1B, 2B and 3B.	143
2.32.1.	Alarm nos. 58.1 – 60:1 "Extract air fan no. 1B – 3B, communication error"	143
2.32.2.	Alarm nos. 58.2 – 60:2 "Extract air fan no. 1B – 3B over current"	144
2.32.3.	Alarm nos. 58.3 – 60:3 "Extract air fan no. 1B – 3B under voltage"	144
2.32.4.	Alarm nos. 58.4 – 60:4 "Extract air fan no. 1B – 3B over voltage"	144
2.32.5.	Alarm nos. 58.5 – 60:5 "Extract air fan no. 1B – 3B over temperature"	144
2.32.6.	Alarm nos. 58.6 – 60:6 "Extract air fan no. 1B – 3B fan motor blocked"	144
2.32.7.	Alarm nos. 58.7 – 60:7 "Extract air fan no. 1B – 3B ripple error"	145
2.32.8.	Alarm nos. 58.8 – 60:8 "Extract air fan no. 1B – 3B phase error"	145
2.32.9.	Alarm nos. 58.9 – 60:9 "Extract air fan no. 1B – 3B EEprom error"	145
2.32.10.	Alarm nos. 58.10 – 60:10 "Extract air fan no. 1B – 3B current limitation"	145

1. General

The layout for the instructions for troubleshooting is based on the alarm list in the GOLD version E.

Find the current tripped alarm in the list and follow the instructions in the rectangles.
The instruction is followed by a question, which has Yes or No as possible response.

Follow the arrow for the correct response to the next instruction. Disregard all instructions that come after incorrect response options.

1.1 Authorisation

Only instructed personnel who are trained and have been informed of the risks involved and the correct way to handle components shall be allowed to carry out tests and troubleshoot while the air handling unit is energised.

The technicians who will be taking measurements of the equipment while it is energised, shall have been trained in electro technology, shall have information about the functions of the air handling unit and shall have sufficient experience enabling them to avoid the hazards which electricity and moving parts can involve.

Fault tracing tripped alarm GOLD E			Document no.	Revision	Page
					7 (146)
Date released		Supersedes			
Type of document	Drawn up by	Revised by	Released and published by		
Instruktion	Bertil Sjunnesson	Magnus Hallén			

2. Tripped alarms

2.1. Alarm group 1: FIRE ALARMS

2.1.1. Alarm no. 1:1 – 1:2 "External fire alarm no. 1/2 tripped" The alarm trips when the external connection between Terminals 6-7 or Terminals 8-9 on the IQLogic control unit is broken.

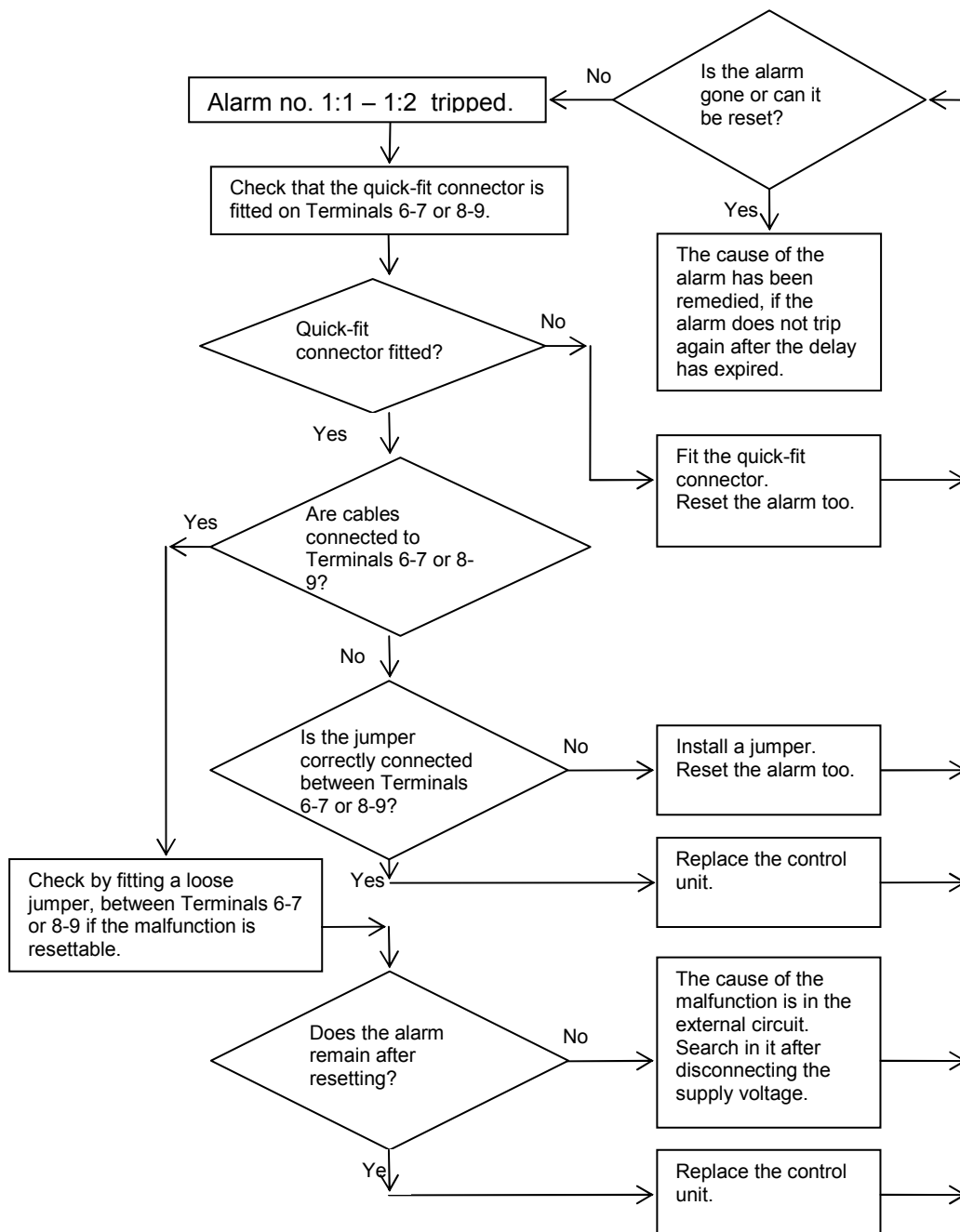

Fault tracing tripped alarm GOLD E			Document no.	Revision	Page
					8 (146)
			Date released	Supersedes	
Type of document	Drawn up by	Revised by	Released and published by		
Instruktion	Bertil Sjunnesson	Magnus Hallén			

2.1.2. Alarm no. 1:3 "Internal fire alarm tripped"

The alarm is only enabled when the "Internal fire alarm" function is enabled in the hand-held terminal under "Settings" – "Installation" – "Alarm priority". The alarm trips when the SA temp. sensor measures a temperature above 70°C or the EA temp. sensor measures a temperature above 50°C.

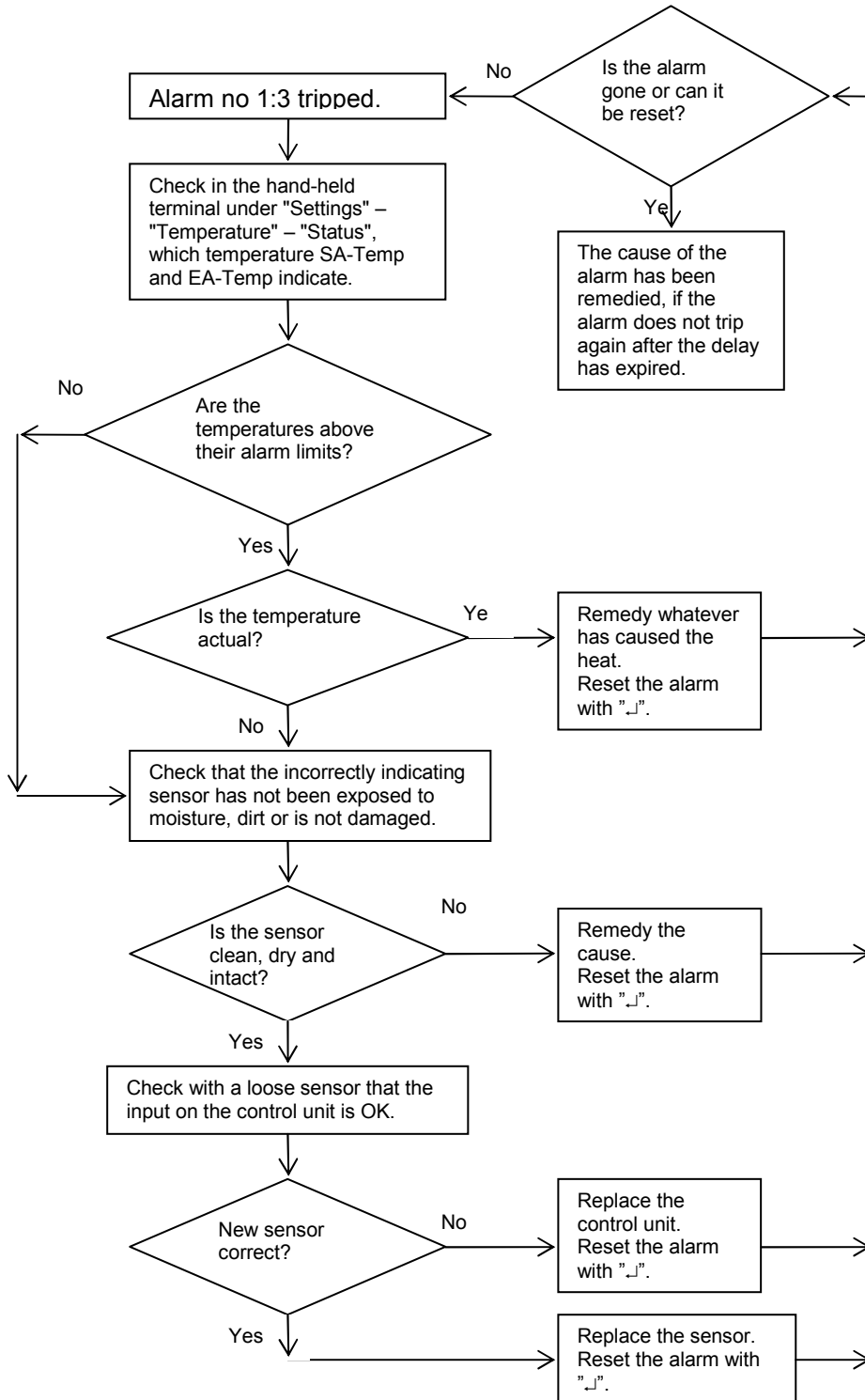

Fault tracing tripped alarm GOLD E			<i>Document no.</i>	<i>Revision</i>	<i>Page</i>
					9 (146)
			<i>Date released</i>	<i>Supersedes</i>	
<i>Type of document</i>	<i>Drawn up by</i>	<i>Revised by</i>	<i>Released and published by</i>		
Instruktion	Bertil Sjunnesson	Magnus Hallén			

2.2. Alarm group 2: EXTERNAL ALARMS

2.2.1. Alarm no. 2:1 – 2:2 "External alarm no. 1/2 tripped"

The alarms are always enabled.

The alarms trip when the relevant terminal input has the preset function for alarms.

The corresponding input for "External Alarm 1/2, input" can, under "Alarm priority" in the HMI, be set to initiate alarms in the event of a "Closed circuit" or an "Open circuit".

External Alarm 1 should be connected to Terminals 10 – 11 on the IQLogic control unit.

External Alarm 2 should be connected to Terminals 12 – 13 on the IQLogic control unit.

Check the external alarm circuits.

Fault tracing tripped alarm GOLD E			Document no.	Revision	Page
					10 (146)
			Date released	Supersedes	
Type of document	Drawn up by	Revised by	Released and published by		
Instruktion	Bertil Sjunnesson	Magnus Hallén			

2.3. Alarm group 3: PRE-HEAT ALARMS

2.3.1. Alarm no. 3:1 "Pre-heat, I/O module no. 9 communication error"

The alarm of the IQLogic+ module is enabled when some Pre-heat function is activated.
The alarm trips if the control unit does not achieve correct communication with the module.

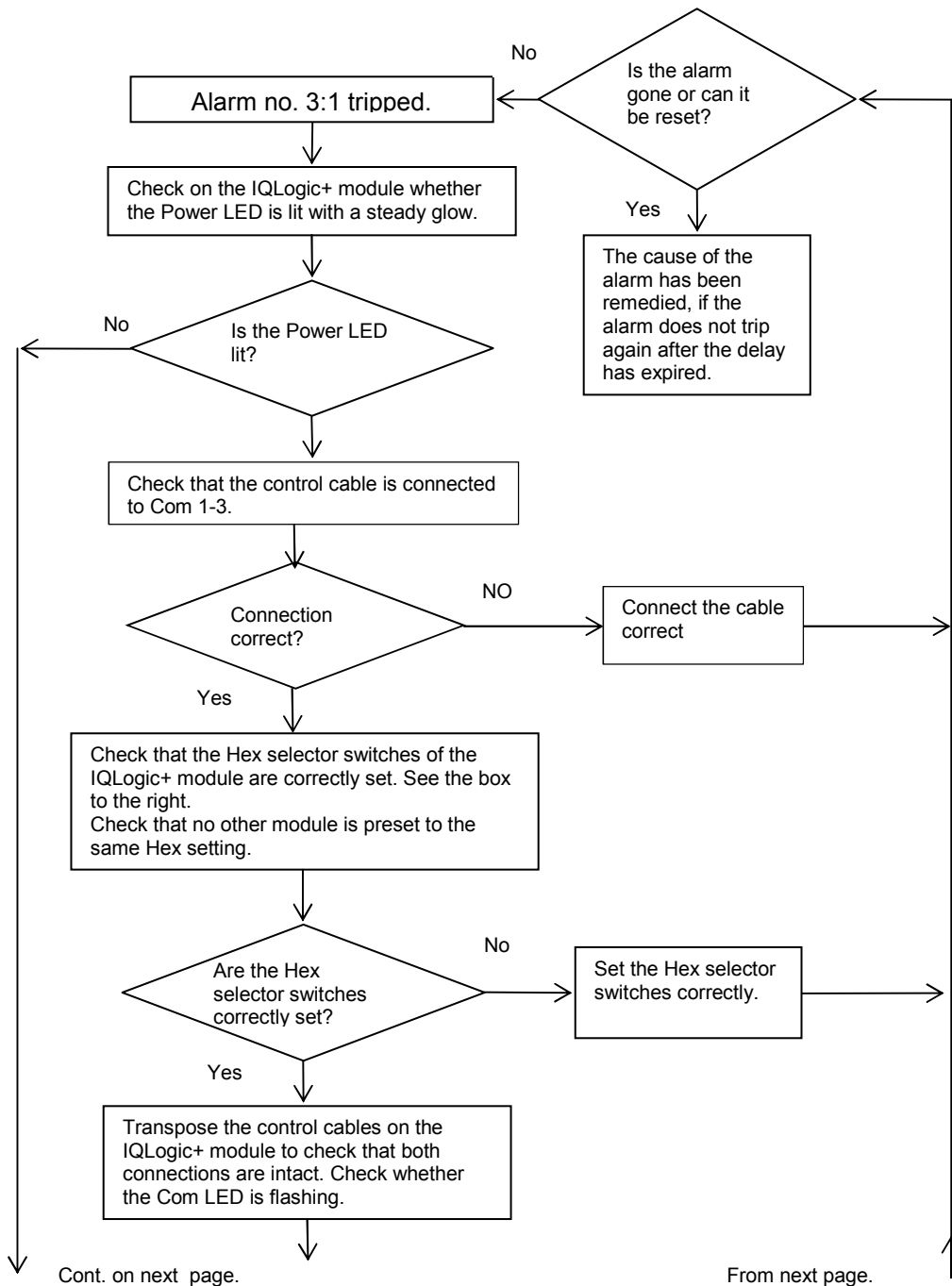

Fault tracing tripped alarm GOLD E			Document no.	Revision	Page
					11 (146)
			Date released	Supersedes	
Type of document	Drawn up by	Revised by	Released and published by		
Instruktion	Bertil Sjunnesson	Magnus Hallén			

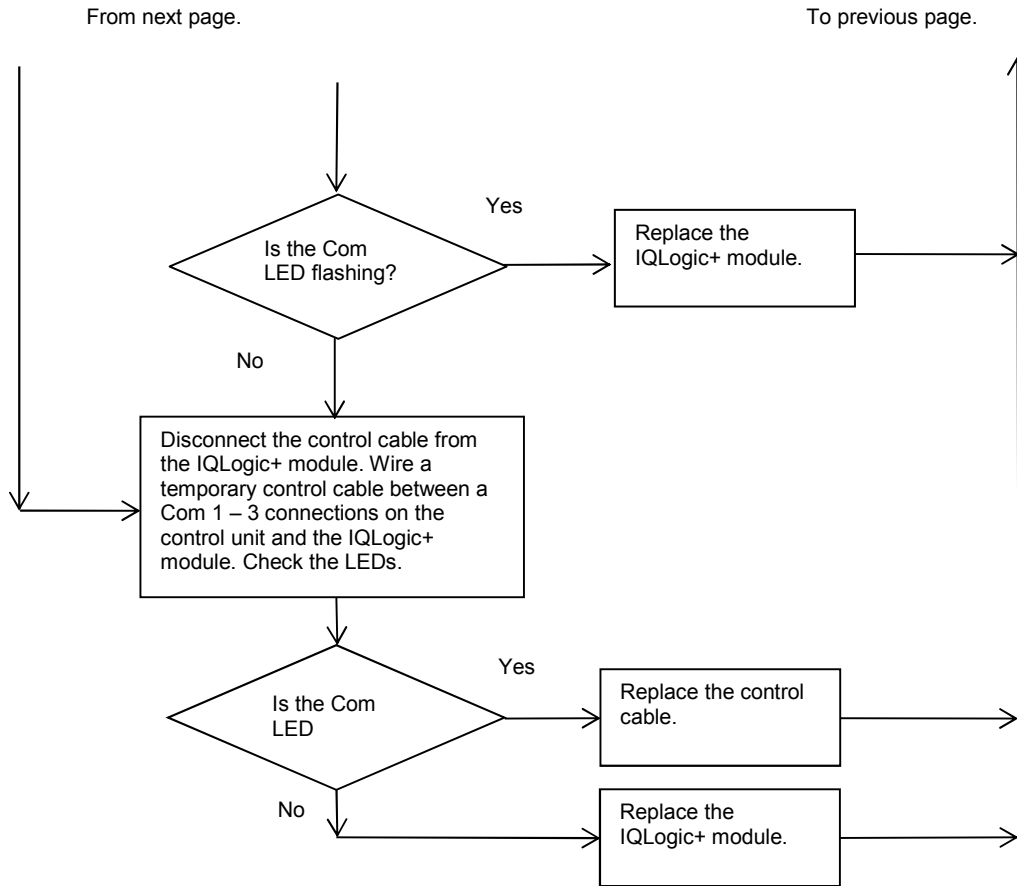

Hex settings:	IQLogic
External monitoring = 3.	Medium
Humidification = 4.	Small
SMART / AQUA Link = 5.	Small
External monitoring = 6.	Medium
AYC = 7.	Medium
Booster diffusers = 8.	Medium
Pre-heat = 9.	Medium
Xzone = A.	Medium
Xzone = B.	Medium
Extra regulation sequence = E	Medium

Fault tracing tripped alarm GOLD E			Document no.	Revision	Page
					12 (146)
			Date released	Supersedes	
Type of document	Drawn up by	Revised by	Released and published by		
Instruktion	Bertil Sjunnesson	Magnus Hallén			

2.3.2. Alarm no. 3:2 "Pre-heat, overheated electric air heater tripped"

The alarm is only enabled when pre-heat with electric air heater is activated.

The alarms trip when there is no connection between the wires for alarms in the communication cable from the electric air heater. Contactor K1 is not energised.

The modular cable should be connected to the RJ45 connection marked "Heat/Cool".

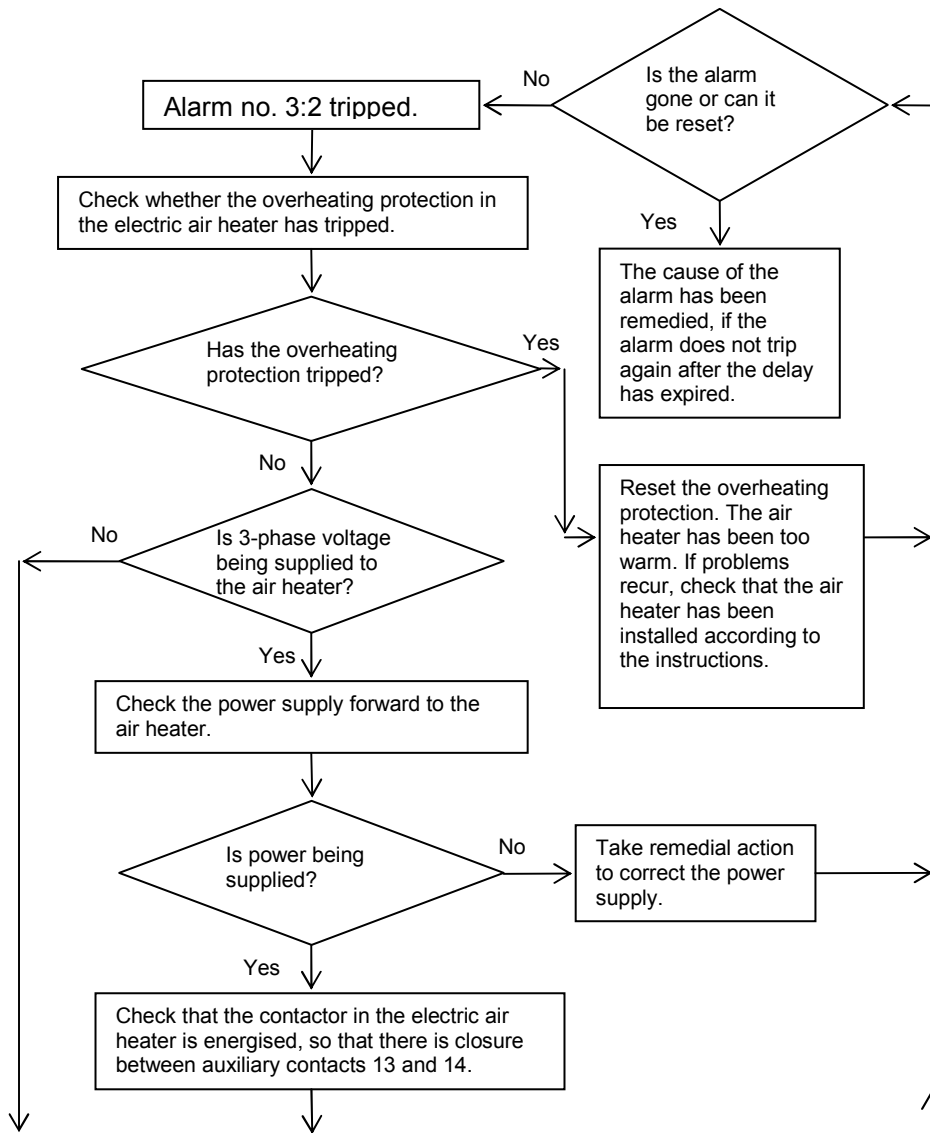

Contd. on next page.

From next page.

Fault tracing tripped alarm GOLD E			<i>Document no.</i>	<i>Revision</i>	<i>Page</i>
					13 (146)
			<i>Date released</i>	<i>Supersedes</i>	
<i>Type of document</i> Instruktion	<i>Drawn up by</i> Bertil Sjunnesson	<i>Revised by</i> Magnus Hallén	<i>Released and published by</i>		

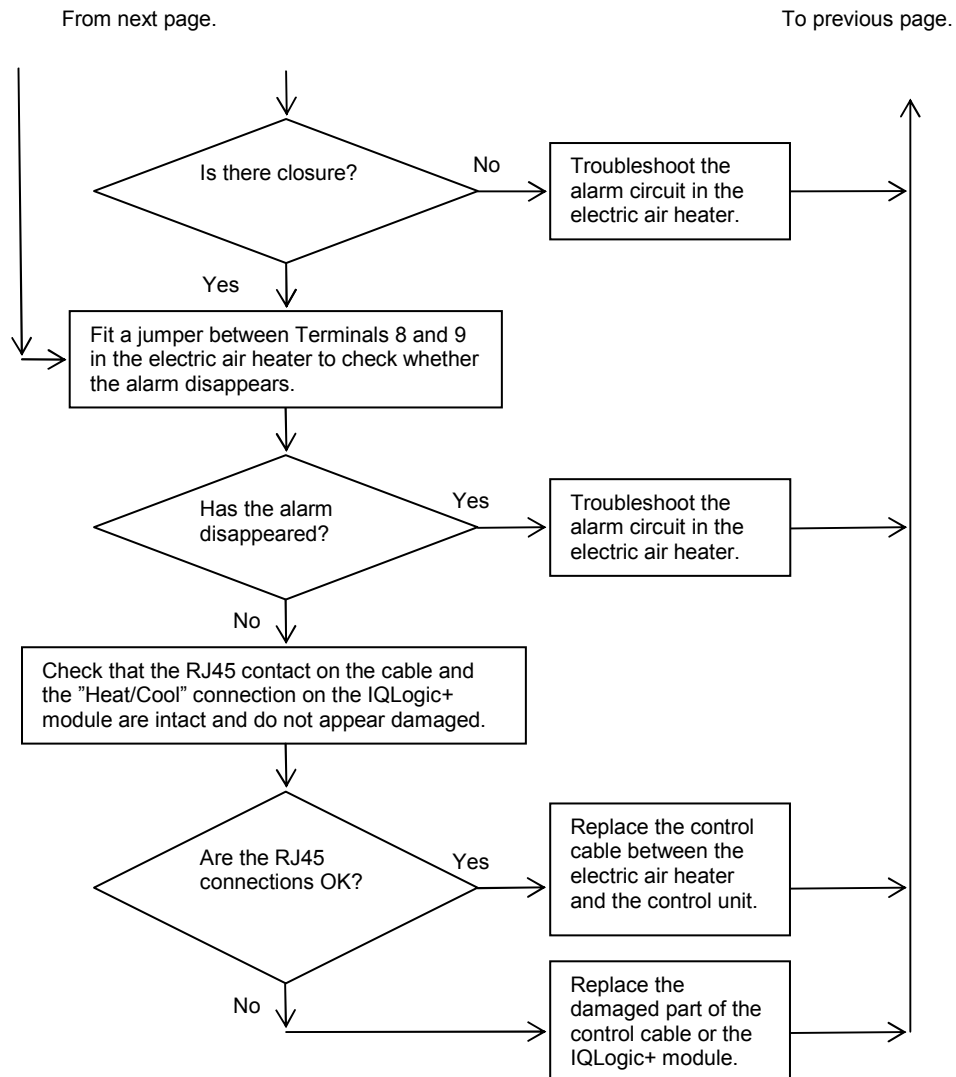

Fault tracing tripped alarm GOLD E			Document no.	Revision	Page
					14 (146)
			Date released	Supersedes	
Type of document	Drawn up by	Revised by	Released and published by		
Instruktion	Bertil Sjunnesson	Magnus Hallén			

2.3.3. Alarm no. 3:3 "Pre-heat, frost guard alarm tripped"

The alarm is only enabled when Pre-heat is activated and a type10 water coil is connected.
 The alarm trips when the frost guard temp. sensor measures a temperature below the preset alarm limit.
 The alarm limit is factory preset to 7°C.

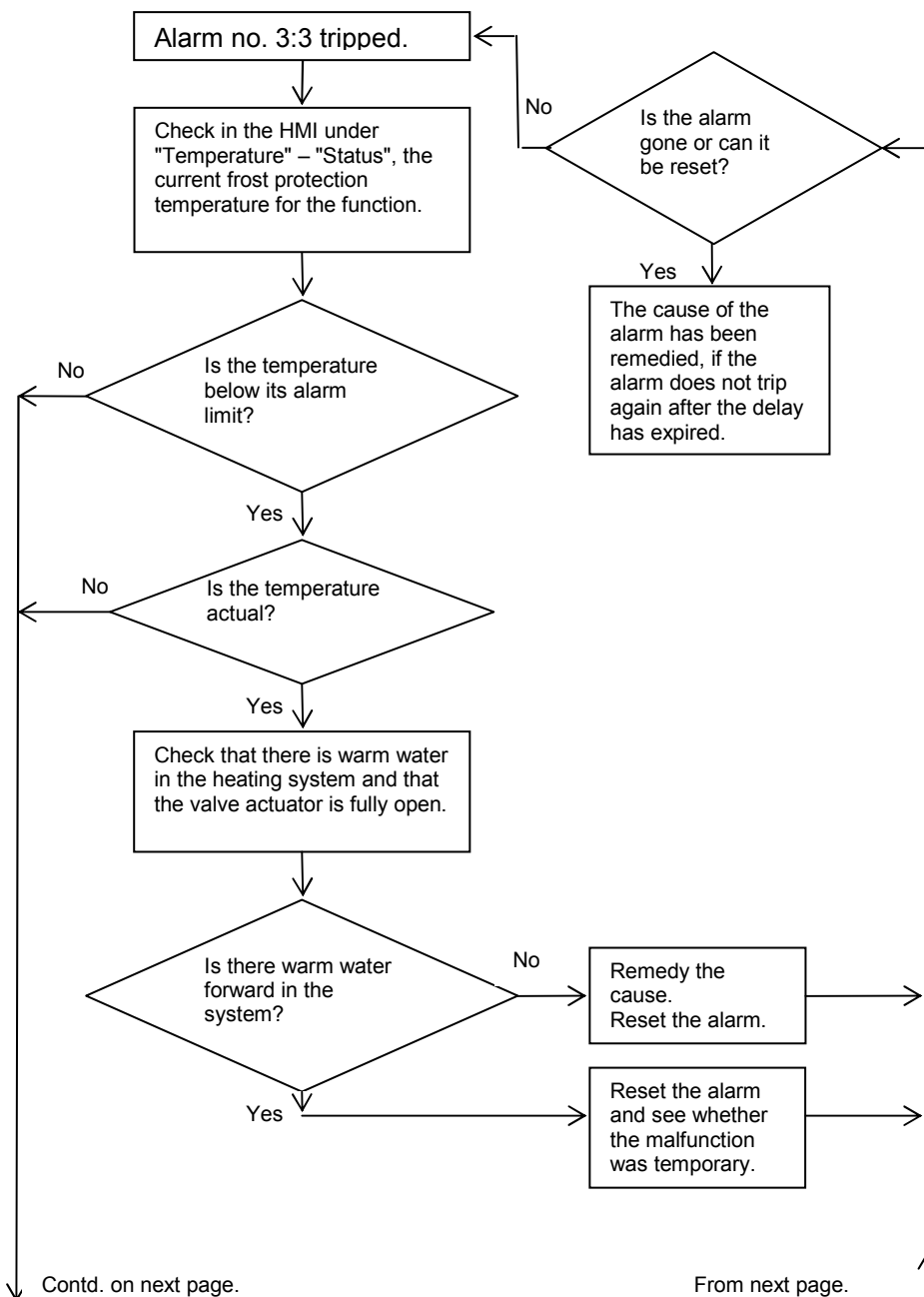

Fault tracing tripped alarm GOLD E			<i>Document no.</i>	<i>Revision</i>	<i>Page</i>
					15 (146)
			<i>Date released</i>	<i>Supersedes</i>	
<i>Type of document</i> Instruktion	<i>Drawn up by</i> Bertil Sjunnesson	<i>Revised by</i> Magnus Hallén	<i>Released and published by</i>		

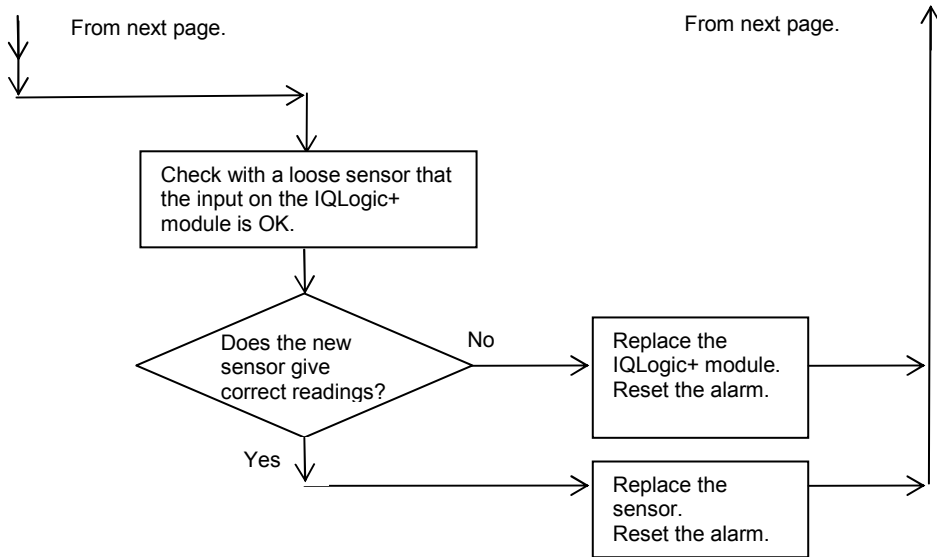

Fault tracing tripped alarm GOLD E			Document no.	Revision	Page
					16 (146)
			Date released	Supersedes	
Type of document Instruktion	Drawn up by Bertil Sjunnesson	Revised by Magnus Hallén	Released and published by		

2.3.4. Alarm no. 3:4 "Pre-heat, frost guard sensor defective"

The alarm is only enabled when Pre-heat is activated and a type10 water coil is connected.
The alarm trips when the control unit does not have communication with the frost guard temperature sensor or when the sensor measures temperatures outside the range of measurement (-55°C – 125°C).

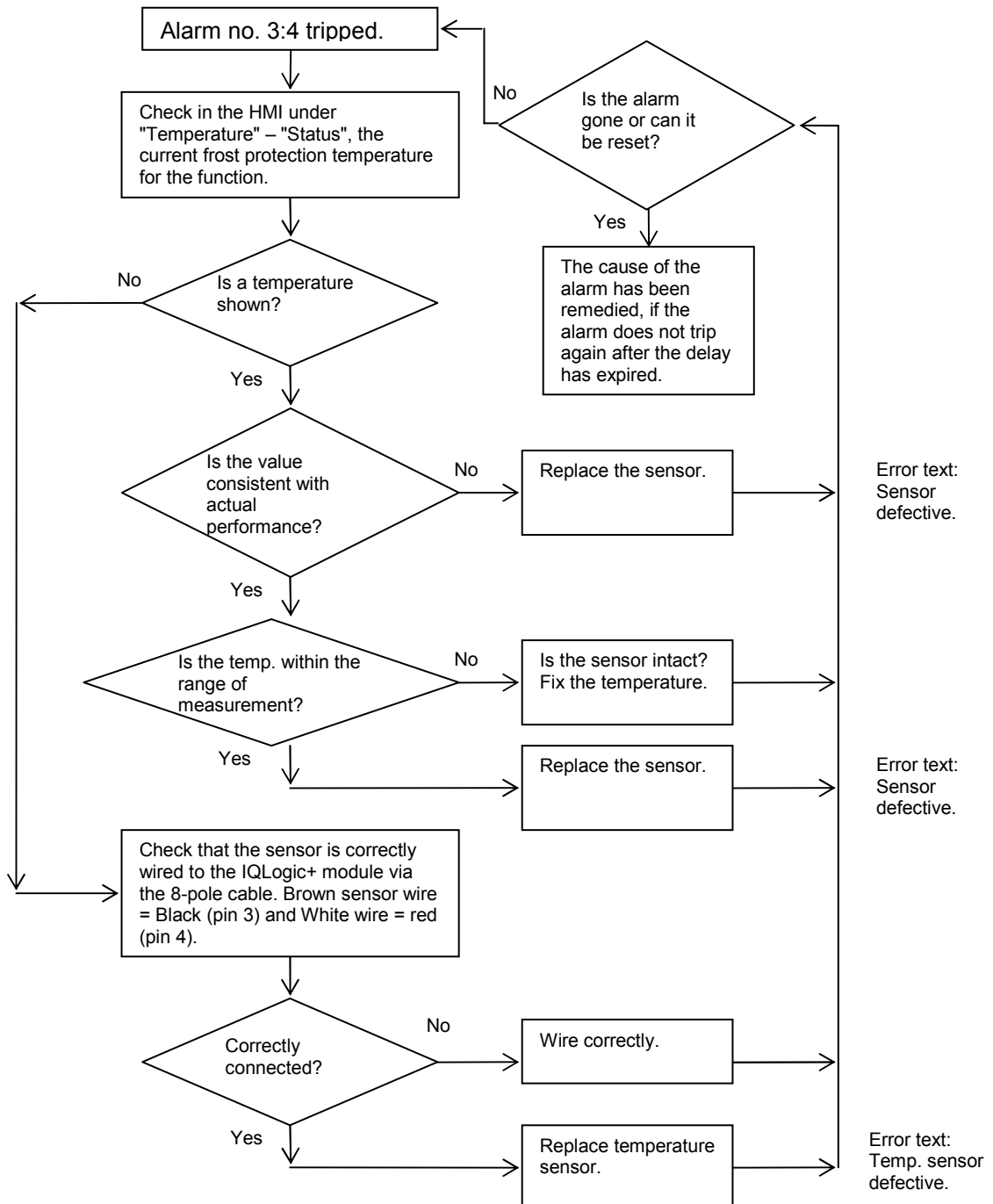

2.3.5. Alarm no. 3:5 "Pre-heat, frost guard sensor defective"

The alarm is enabled when the Pre-heat function is activated. The sensors are assumed to always be connected to the IQLogic+ module.

Fault tracing tripped alarm GOLD E			Document no.	Revision	Page
					17 (146)
			Date released	Supersedes	
Type of document	Drawn up by	Revised by	Released and published by		
Instruktion	Bertil Sjunnesson	Magnus Hallén			

The alarms trip when the control unit does not have communication with the temperature sensor or when the sensor measures temperatures outside the range of measurement (-55°C – 125°C).

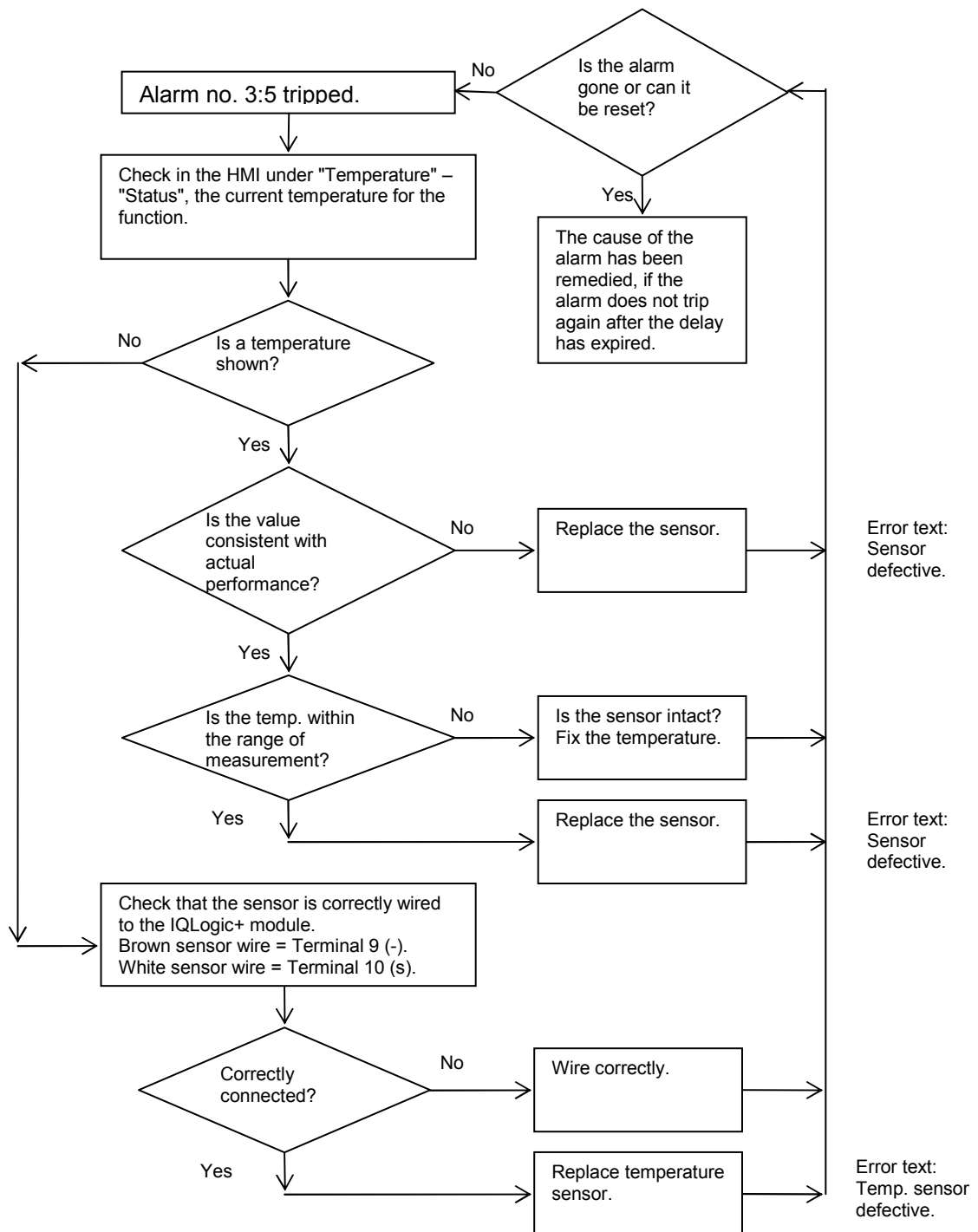

2.3.6. Alarm no. 3:6 "Pre-heat, valve monitoring tripped"

The alarm is only enabled when Pre-heat is activated, the type 9 or 10 water coil is connected and Valve monitoring has been manually activated. The alarm trips when the feedback signal (input signal) from the valve

Fault tracing tripped alarm GOLD E			Document no.	Revision	Page
					18 (146)
			Date released	Supersedes	
Type of document	Drawn up by	Revised by	Released and published by		
Instruktion	Bertil Sjunnesson	Magnus Hallén			

actuator does not agree with the control signal. For a 0% output signal the feedback must be < 8% and for a 100% output signal >92% so that the alarm will not trip.

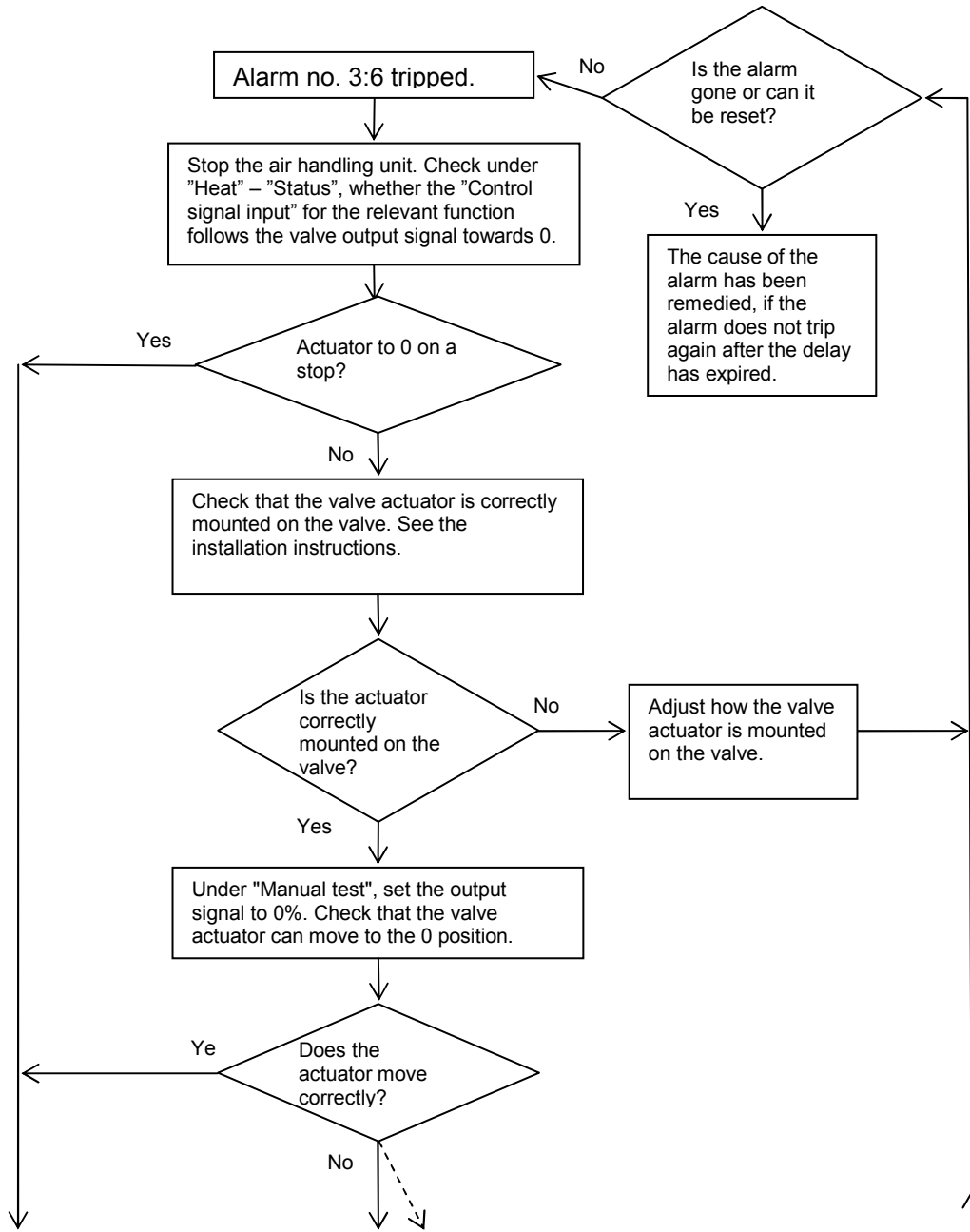

Contd. on next page.

From next page.

Fault tracing tripped alarm GOLD E			Document no.	Revision	Page
					19 (146)
			Date released	Supersedes	
Type of document	Drawn up by	Revised by	Released and published by		
Instruktion	Bertil Sjunnesson	Magnus Hallén			

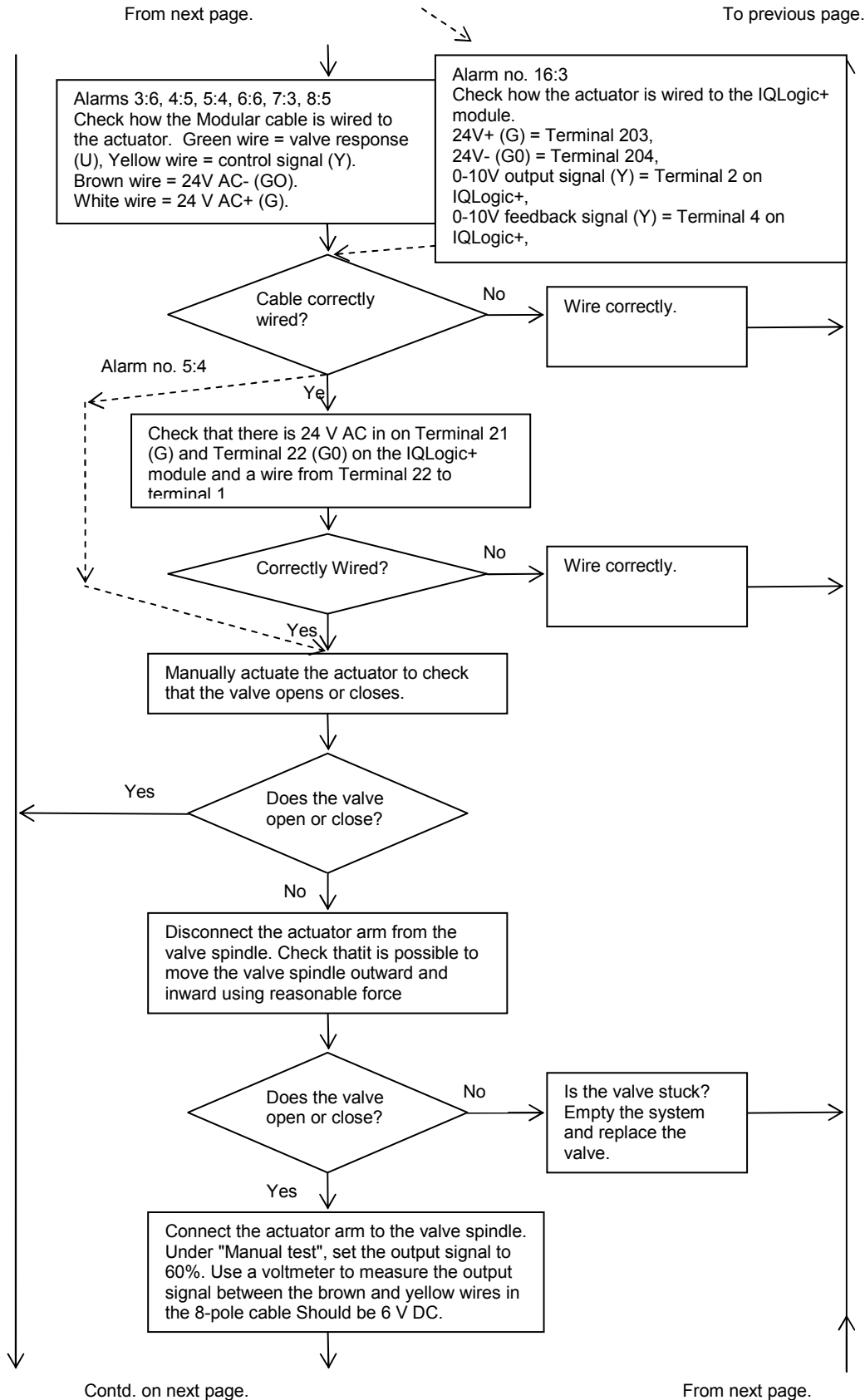

Fault tracing tripped alarm GOLD E			Document no.	Revision	Page
					20 (146)
			Date released	Supersedes	
Type of document	Drawn up by	Revised by	Released and published by		
Instruktion	Bertil Sjunnesson	Magnus Hallén			

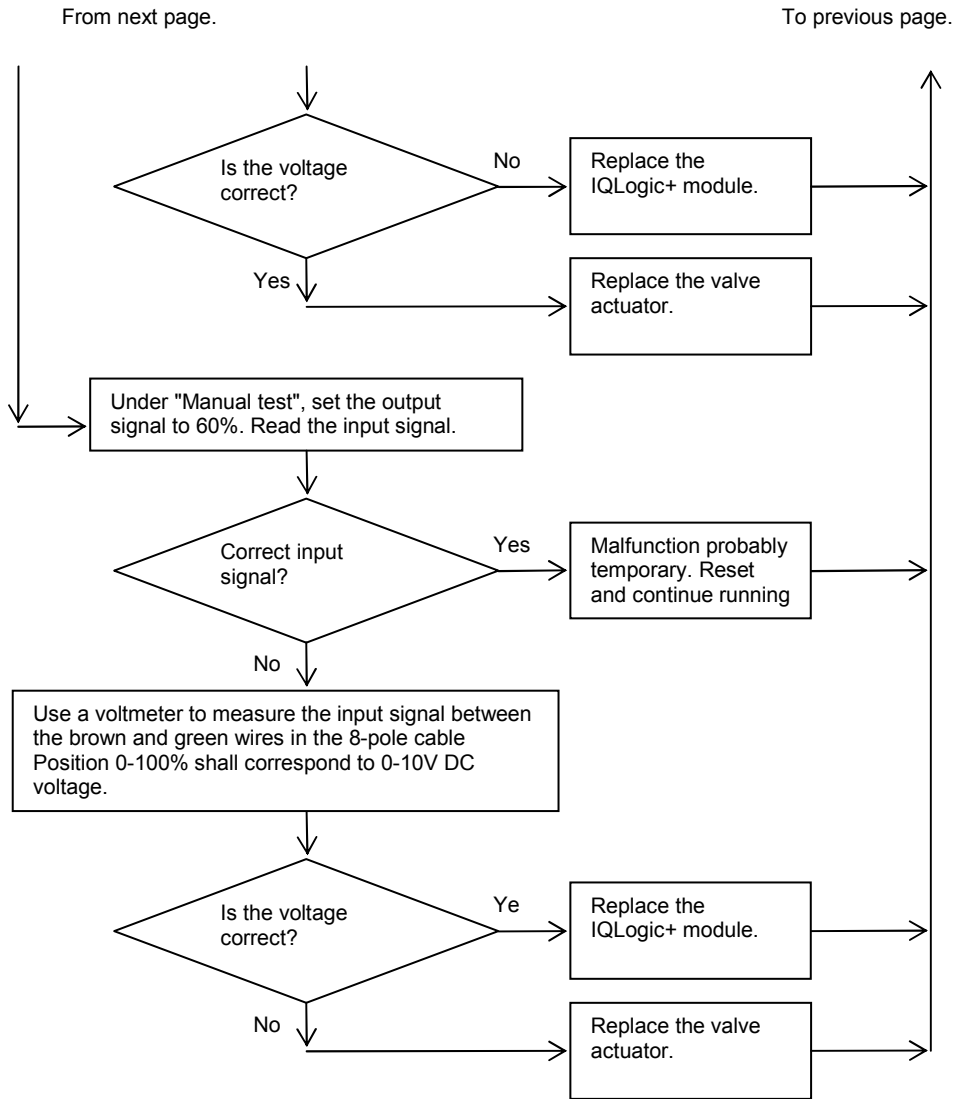

Fault tracing tripped alarm GOLD E			Document no.	Revision	Page
					21 (146)
			Date released	Supersedes	
Type of document Instruktion	Drawn up by Bertil Sjunnesson	Revised by Magnus Hallén	Released and published by		

2.3.7. Alarm no. 3:7 "Pre-heat, temperature below set point"

The alarm is enabled when the Pre-heat function is activated.

The alarms trip when the temperature downstream of the pre-heat coil is below the relevant set point for more than 20 minutes. Check that the preset alarm limit is appropriate.

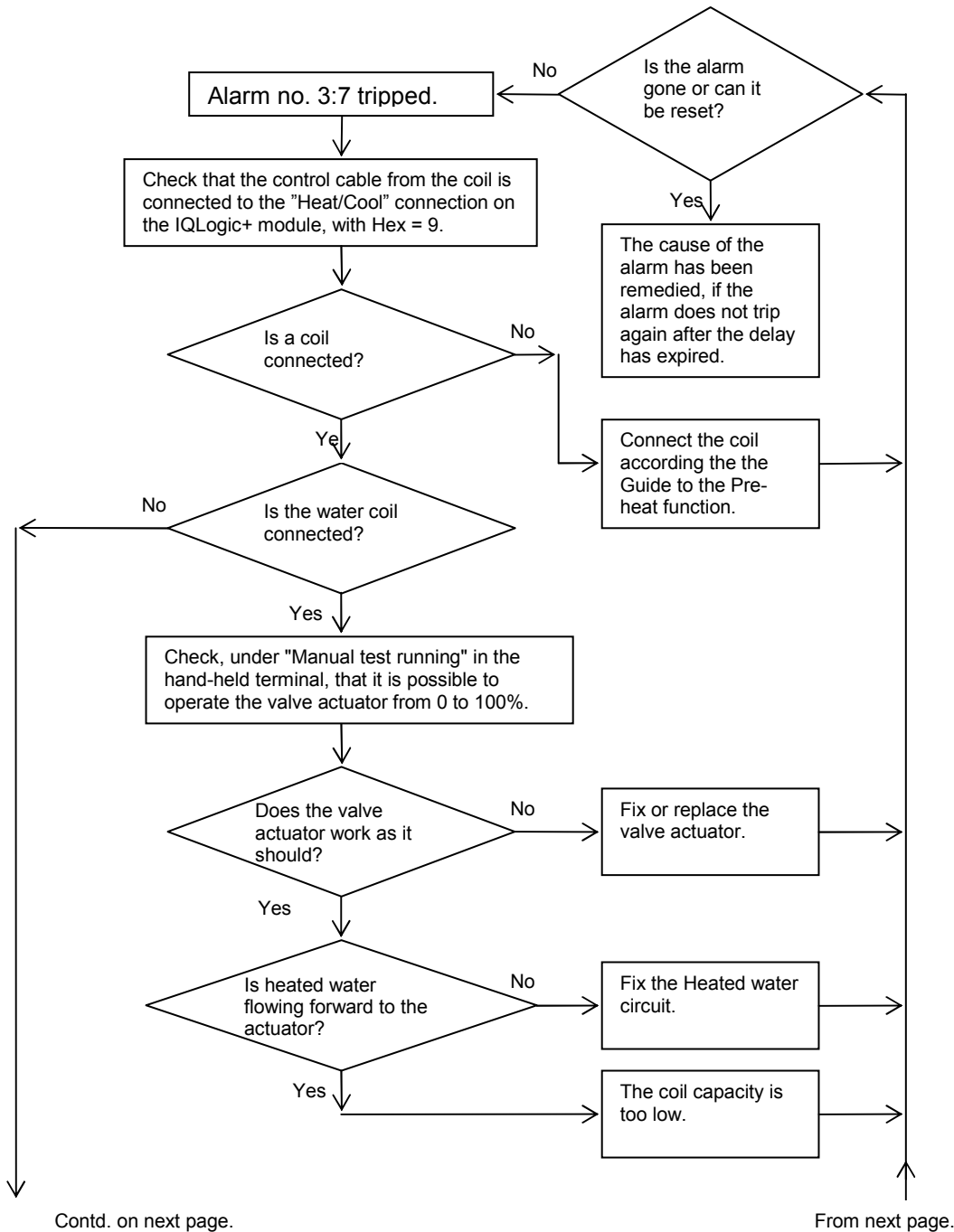

Fault tracing tripped alarm GOLD E			Document no.	Revision	Page
					22 (146)
			Date released	Supersedes	
Type of document	Drawn up by	Revised by	Released and published by		
Instruktion	Bertil Sjunnesson	Magnus Hallén			

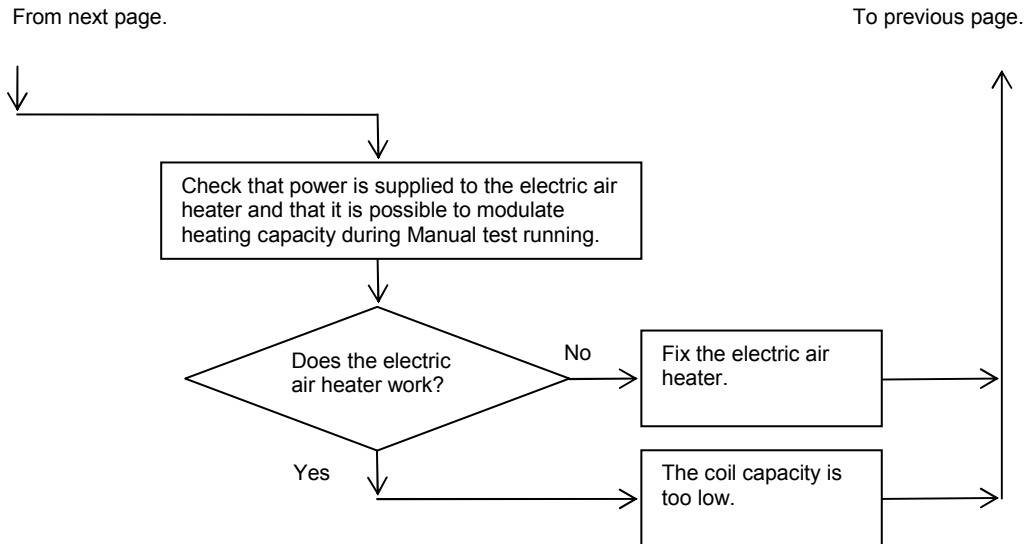

2.3.8. Alarm no. 3:8 "Pre-heat, alarm input tripped"

The alarm trips if the pre-heat function is activated and, depending on which function is selected, alarm is obtained on receiving a fault indication on the input.

Optional functions: "Alarm at open contact", "Alarm at closed contact" and "Contactor function".
 Contactor function means that the alarm input must close within 3 seconds after the Pump output has been energised. The function is used when a contactor is used for controlling the pump. An alarm is also initiated if the alarm input is closed when the pump should not be in operation.

Check the Pre-heat output and input under "Heat – Status".

Fault tracing tripped alarm GOLD E			<i>Document no.</i>	<i>Revision</i>	<i>Page</i>
					23 (146)
			<i>Date released</i>	<i>Supersedes</i>	
<i>Type of document</i>	<i>Drawn up by</i>	<i>Revised by</i>	<i>Released and published by</i>		
Instruktion	Bertil Sjunnesson	Magnus Hallén			

2.4. Alarm group 4: EXTRA REGULATION SEQUENCE

2.4.1. Alarm no. 4:1 "Extra regulation sequence, module no. E communication error"

The alarm for IQLogic+ module E is enabled when some Extra regulation sequence function is activated for heat or cooling.

The alarm trips if the control unit does not achieve correct communication with the module.

For troubleshooting see Alarm no. 3:1 above.

2.4.2. Alarm no. 4:2 "Extra regulation sequence, overheat, electric air heater tripped"

The alarm is only enabled when the Extra regulation sequence with electric air heater is activated.

The alarms trip when there is no connection between the wires for alarms in the communication cable from the electric air heater.

Contactors K1 is not energised.

The modular cable should be connected to the RJ45 connection marked "Heat/Cool".

For troubleshooting see Alarm no. 3:2 above.

2.4.3. Alarm no. 4:3 "Extra regulation sequence, frost guard alarm tripped"

The alarm is only enabled when Extra regulation sequence is activated and a type10 water coil is connected.

The alarm trips when the frost guard temp. sensor measures a temperature below the preset alarm limit.

The alarm limit is factory preset to 7°C.

For troubleshooting see Alarm no. 3:3 above.

2.4.4. Alarm no. 4:4 "Extra regulation sequence, frost guard sensor defective"

The alarm is only enabled when Extra regulation sequence is activated and a type10 water coil is connected.

The alarm trips when the control unit does not have communication with the frost guard temperature sensor or when the sensor measures temperatures outside the range of measurement (-55°C – 125°C).

For troubleshooting see Alarm no. 3:4 above.

2.4.5. Alarm no. 4:5 "Extra regulation sequence, valve monitoring tripped"

The alarm is only enabled when Extra regulation sequence is activated. a type 9 or 10 water coil is connected and Valve monitoring has been manually activated. The alarm trips when the feedback signal (input signal) from the valve actuator does not agree with the control signal. For a 0% output signal the feedback must be < 8% and for a 100% output signal >92% so that the alarm will not trip.

For troubleshooting see Alarm no. 3:6 above.

Fault tracing tripped alarm GOLD E			Document no.	Revision	Page 24 (146)
			Date released	Supersedes	
Type of document Instruktion	Drawn up by Bertil Sjunnesson	Revised by Magnus Hallén	Released and published by		

2.4.6. Alarm no. 4:6 "Extra regulation sequence 1, Alarm input tripped"

The alarm trips if extra regulation sequence 1 is activated and, depending on which alarm function is activated, alarm is obtained on receiving a fault indication on the input.

Optional functions: "Alarm at open contact", "Alarm at closed contact" and "Contactor function".
Contactor function means that the alarm input must close within 3 seconds after the Pump output has been energised. The function is used when a contactor is used for controlling the pump. An alarm is also initiated if the alarm input is closed when the pump should not be in operation.

2.4.7. Alarm no. 4:7 "Extra regulation sequence 1, temperature protection from communication error"

The alarm trips if the GOLD does not obtain inlet flow temperature in the chilled/heated water circuit from Nestor.

Check that the Nestor is correctly connected and that the temperature is displayed correctly in Nestor.

2.4.8. Alarm no. 4:9 "Extra regulation sequence 2, Communication error I/O module no. F"

The alarm trips if the control unit does not achieve correct communication with the IQlogic+ module.
The alarm is enabled only if the function is selected.

For troubleshooting see Alarm no. 3:1 above.

2.4.9. Alarm no. 4:10 "Extra regulation sequence 2, electrical heater over heat protection tripped"

The alarm trips if the function is activated, the electric air heater is connected and the overheat protection has tripped. The alarm trips if there is no connection between pins 3 and 4 in the 8-pin air heater cable (contactor K1 is not energised)

The modular cable should be connected to the RJ45 connection marked "Heat/Cool".

For troubleshooting. see Alarm no. 3:2 above.

2.4.10. Alarm no. 4:11 "Extra regulation sequence 2, Frost protection tripped"

The alarm trips if the function is activated and when Coil type 10 (water coil with frost protection sensor) is connected and the frost protection sensor measures a temperature below the preset alarm limit.

For troubleshooting, see Alarm no. 3:3 above.

2.4.11. Alarm no. 4:12 "Extra regulation sequence 2, Frost protection temperature sensor defective"

The alarm is only enabled when the function is activated and a type10 water coil is connected.
The alarm trips when the control unit does not have communication with the frost protection temperature sensor or when the sensor measures temperatures outside the range of measurement (-55°C – 125°C).

Fault tracing tripped alarm GOLD E			<i>Document no.</i>	<i>Revision</i>	<i>Page</i>
					25 (146)
			<i>Date released</i>	<i>Supersedes</i>	
<i>Type of document</i>	<i>Drawn up by</i>	<i>Revised by</i>	<i>Released and published by</i>		
Instruktion	Bertil Sjunnesson	Magnus Hallén			

For troubleshooting, see Alarm no. 3:4 above.

2.4.12. Alarm no. 4:13 "Extra regulation sequence 2, valve monitoring tripped"

The alarm trips if cable with 2.2 kohms resistance is connected, the valve monitoring function is activated and the feedback signal from the valve actuator deviates from the output signal.

The alarm trips if the output signal is less than 3% and the feedback is more than 8% or if the output signal is more than 97% and the feedback is less than 92%.

For troubleshooting, see Alarm no. 3:6 above.

2.4.13. Alarm no. 4:14 "Extra regulation sequence 2, alarm input tripped"

The alarm trips if Extra regulation sequence 2 is selected and, depending on which alarm function is activated, alarm is obtained on receiving a fault indication on the input.

Optional functions: "Alarm at open contact", "Alarm at closed contact" and "Contactor function".

Contactor function means that the alarm input must close within 3 seconds after the Pump output has been energised. The function is used when a contactor is used for controlling the pump. An alarm is also initiated if the alarm input is closed when the pump should not be in operation.

2.5. Alarm group 5: RE-HEAT

2.5.1. Alarm no. 5:1 "Re-heat, overheated electric air heater tripped"

The alarm is only enabled when Re-heat with a type 1-6 or 11-15 coil, electric air heater is connected to the "Heat" connection on the IQLogic control unit.

The alarms trip when there is no connection between the wires for alarms in the communication cable from the electric air heater.

Contactor K1 is not energised.

For troubleshooting see Alarm no. 3:2 above.

2.5.2. Alarm no. 5:2 "Re-heat, frost guard alarm tripped"

The alarm is only enabled when Re-heat with a type 10 water coil with frost guard is connected to the "Heat" connection on the IQLogic control unit.

The alarm trips when the frost guard temp. sensor measures a temperature below the preset alarm limit.

The alarm limit is factory preset to 7°C.

For troubleshooting see Alarm no. 3:3 above.

2.5.3. Alarm no. 5:3 "Re-heat, frost guard sensor defective"

The alarm is only enabled when Re-heat with a type 10 water coil with frost guard is connected to the "Heat" connection on the IQLogic control unit.

The alarm trips when the control unit does not have communication with the frost guard temperature sensor or when the sensor measures temperatures outside the range of measurement (-55°C – 125°C).

For troubleshooting see Alarm no. 3:4 above.

Fault tracing tripped alarm GOLD E			<i>Document no.</i>	<i>Revision</i>	<i>Page</i>
					26 (146)
			<i>Date released</i>	<i>Supersedes</i>	
<i>Type of document</i>	<i>Drawn up by</i>	<i>Revised by</i>	<i>Released and published by</i>		
Instruktion	Bertil Sjunnesson	Magnus Hallén			

2.5.4. Alarm no. 5:4 "Re-heat, valve monitoring tripped"

The alarm is only enabled when Re-heat with a type 10 water coil with frost guard is connected to the "Heat" connection on the IQLogic control unit and Valve monitoring has been manually activated. The alarm trips when the feedback signal (input signal) from the valve actuator does not agree with the control signal. For a 0% output signal the feedback must be < 8% and for a 100% output signal >92% so that the alarm will not trip.

For troubleshooting see Alarm no. 3:6 above.

Fault tracing tripped alarm GOLD E			<i>Document no.</i>	<i>Revision</i>	<i>Page</i>
					27 (146)
			<i>Date released</i>	<i>Supersedes</i>	
<i>Type of document</i>	<i>Drawn up by</i>	<i>Revised by</i>	<i>Released and published by</i>		
Instruktion	Bertil Sjunnesson	Magnus Hallén			

2.6. Alarm group 6: XZONE MODULE NO. A

2.6.1. Alarm no. 6:1 "Xzone, I/O module no. A communication error"

The alarm for IQLogic+ module A is enabled when some Xzone function is activated for heat or cooling. The alarm trips if the control unit does not achieve correct communication with the module. For troubleshooting see Alarm no. 3:1 above.

2.6.2. Alarm no. 6:2 "Xzone, overheat, electric air heater tripped"

The alarm for IQLogic+ module A is enabled when some Xzone function is activated for heat or cooling. The alarms trip when there is no connection between the wires for alarms in the communication cable from the electric air heater. Contactor K1 is not energised. The modular cable should be connected to the RJ45 connection marked "Heat/Cool". For troubleshooting see Alarm no. 3:2 above.

2.6.3. Alarm no. 6:3 "Xzone, frost guard alarm tripped"

The alarm is only enabled when Xzone, heat is activated and a type 10 water coil is connected. The alarm trips when the frost guard temp. sensor measures a temperature below the preset alarm limit. The alarm limit is factory preset to 7°C. For troubleshooting see Alarm no. 3:3 above.

2.6.4. Alarm no. 6:4 "Xzone, frost protection temp. sensor defective"

The alarm is only enabled when Xzone, heat is activated and a type 10 water coil is connected. The alarm trips when the control unit does not have communication with the frost guard temperature sensor or when the sensor measures temperatures outside the range of measurement (-55°C – 125°C). For troubleshooting see Alarm no. 3:4 above.

2.6.5. Alarm no. 6:5 "Xzone, SA temperature sensor defective"

The alarm is enabled when the Xzone function is activated. The sensors are assumed to always be connected to the IQLogic+ module. The alarms trip when the control unit does not have communication with the temperature sensor or when the sensor measures temperatures outside the range of measurement (-55°C – 125°C). For troubleshooting see Alarm no. 3:5 above.

2.6.6. Alarm no. 6:6 "Xzone, heat valve monitoring tripped"

The alarm is only enabled when Xzone, Heat is activated, a type 10 water coil is connected and manual valve monitoring is activated. The alarm trips when the feedback signal (input signal) from the valve actuator does not agree with the control signal. For a 0% output signal the feedback must be < 8% and for a 100% output signal >92% so that the alarm will not trip. For troubleshooting see Alarm no. 3:6 above.

Fault tracing tripped alarm GOLD E			Document no.	Revision	Page
					28 (146)
			Date released	Supersedes	
Type of document Instruktion	Drawn up by Bertil Sjunnesson	Revised by Magnus Hallén	Released and published by		

2.6.7. Alarm no. 6:7 "Xzone, SA temperature below set point"

The alarm is enabled when the Xzone function is activated.

The alarms trip when the temperature downstream of the pre-heat coil is below the relevant set point for more than 20 minutes. Check that the preset alarm limit is appropriate.

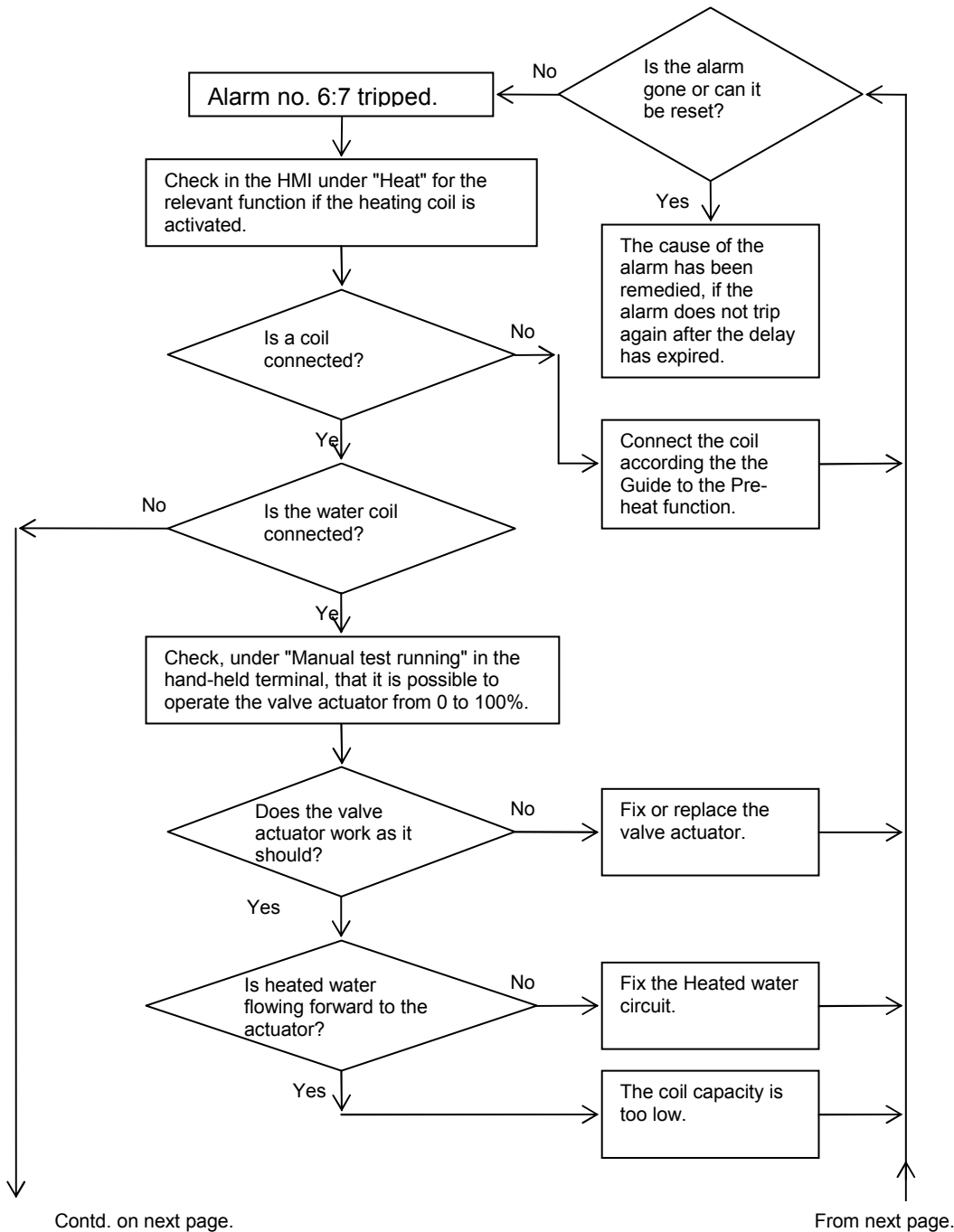

Fault tracing tripped alarm GOLD E			<i>Document no.</i>	<i>Revision</i>	<i>Page</i>
					29 (146)
			<i>Date released</i>	<i>Supersedes</i>	
<i>Type of document</i> Instruktion	<i>Drawn up by</i> Bertil Sjunnesson	<i>Revised by</i> Magnus Hallén	<i>Released and published by</i>		

From next page.

To previous page.

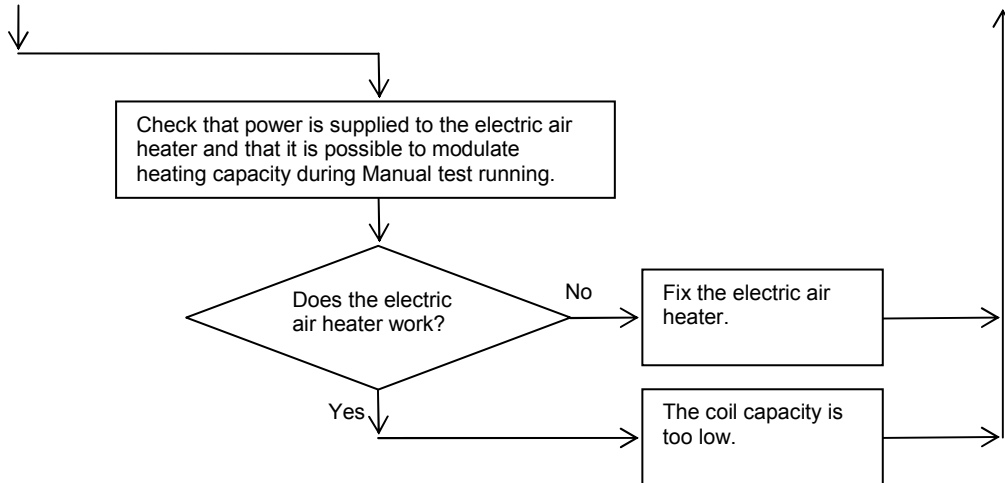

Fault tracing tripped alarm GOLD E			Document no.	Revision	Page
					30 (146)
			Date released	Supersedes	
Type of document	Drawn up by	Revised by	Released and published by		
Instruktion	Bertil Sjunnesson	Magnus Hallén			

2.6.8. Alarm no. 6:8 "Xzone, SA temperature above set point"

The alarm is enabled when the Xzone function is activated.

The alarms trip when the temperature downstream of the pre-heat coil is above the relevant set point for more than 20 minutes. Check that the preset alarm limit is appropriate.

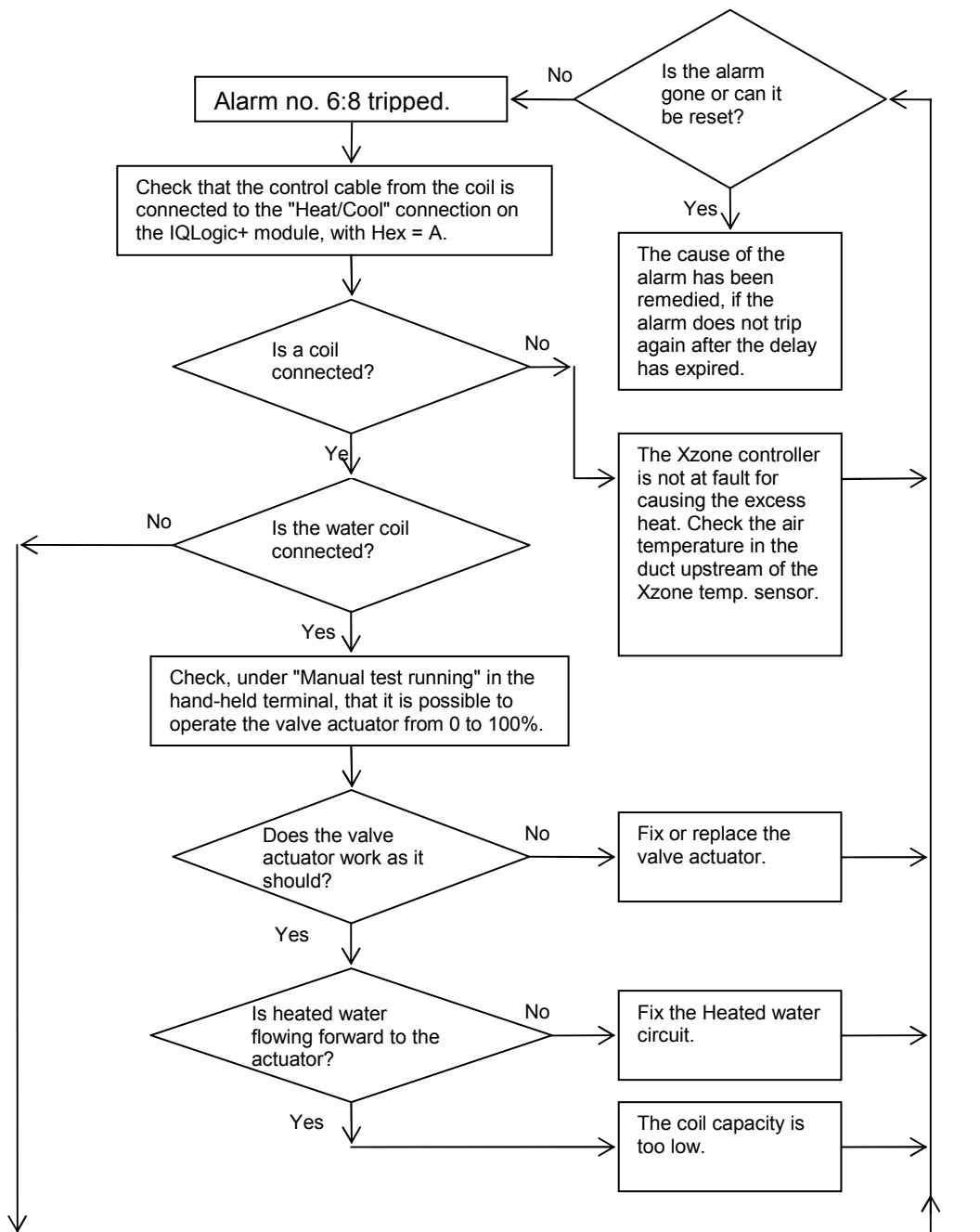

Contd. on next page.

From next page.

Fault tracing tripped alarm GOLD E			Document no.	Revision	Page 31 (146)
			Date released		Supersedes
Type of document Instruktion	Drawn up by Bertil Sjunnesson	Revised by Magnus Hallén	Released and published by		

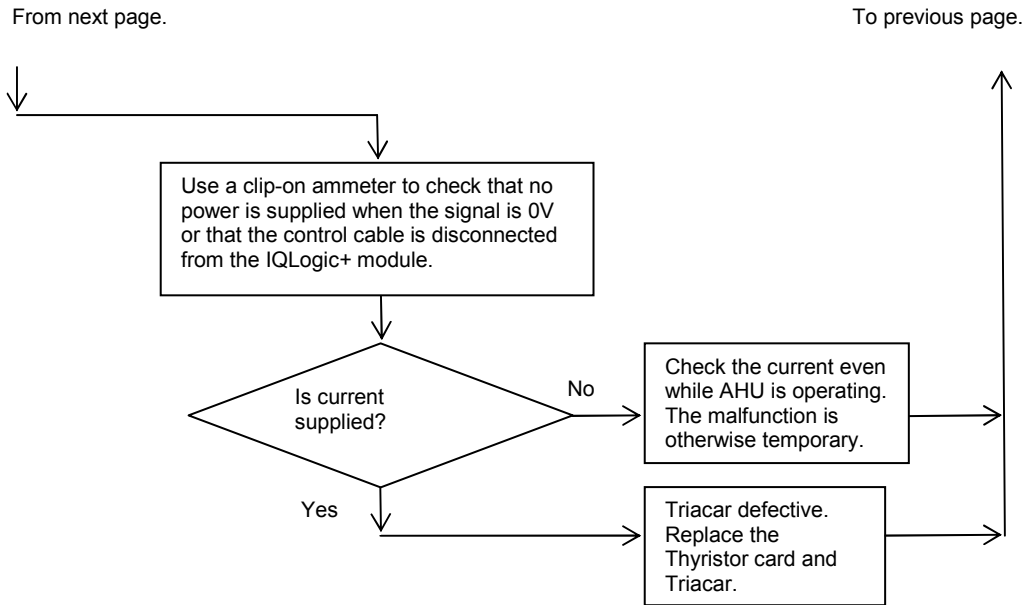

2.6.9. Alarm no. 6:9 "Xzone, heat alarm input tripped"

The alarm is enabled when the Xzone function is activated and, depending on which alarm function is activated, alarm is obtained on receiving a fault indication on the input.

Optional functions: "Alarm at open contact", "Alarm at closed contact" and "Contactor function".
 Contactor function means that the alarm input must close within 3 seconds after the Pump output has been energised. The function is used when a contactor is used for controlling the pump. An alarm is also initiated if the alarm input is closed when the pump should not be in operation.

Fault tracing tripped alarm GOLD E			<i>Document no.</i>	<i>Revision</i>	<i>Page</i>
					32 (146)
			<i>Date released</i>	<i>Supersedes</i>	
<i>Type of document</i>	<i>Drawn up by</i>	<i>Revised by</i>	<i>Released and published by</i>		
Instruktion	Bertil Sjunnesson	Magnus Hallén			

2.7. Alarm group 7: XZONE MODULE NO. B

2.7.1. Alarm 7:1 "Xzone, I/O module no. B communication error"

The alarm for IQLogic+ module B is enabled when some Xzone function is activated for heat or cooling. The alarm trips if the control unit does not achieve correct communication with the module.

For troubleshooting see Alarm no. 3:1 above.

2.7.2. Alarm no. 7:2 "Xzone, EA temperature sensor defective"

The alarm is enabled when the Xzone function is activated, ERS or Extract air regulation for the Xzone has been selected and no External room temperature sensor, communication, is connected. The EA sensors shall be connected to IQLogic+ module B.

The alarms trip when the control unit does not have communication with the temperature sensor or when the sensor measures temperatures outside the range of measurement (-55°C – 125°C).

For troubleshooting see Alarm no. 3:5 above.

2.7.3. Alarm no. 7:3 "Xzone, cool valve monitoring tripped"

The alarm is only enabled when Xzone,cool is activated, a type 9-10 water coil is connected and manual valve monitoring has been activated. The alarm trips when the feedback signal (input signal) from the valve actuator does not agree with the control signal. For a 0% output signal the feedback must be < 8% and for a 100% output signal >92% so that the alarm will not trip.

For troubleshooting see Alarm no. 3:6 above.

2.7.4. Alarm no. 7:4 "Xzone, EA temperature below set point"

The alarm is enabled when the Xzone function is activated.

The alarms trip when the temperature by an active extract air/room air sensor is below the relevant set point for more than 20 minutes. Check that the preset alarm limit is appropriate.

For troubleshooting see Alarm no. 6:7 above.

2.7.5. Alarm no. 7:5 "Xzone, cool alarm input 1 tripped"

The alarm is enabled when the Xzone function is activated and, depending on which alarm function is activated for alarm input 1, alarm is obtained on receiving a fault indication on the alarm input.

Optional functions: "Alarm at open contact", "Alarm at closed contact" and "Contactor function".
Contactor function means that the alarm input must close within 3 seconds after the Pump output has been energised. The function is used when a contactor is used for controlling the pump. An alarm is also initiated if the alarm input is closed when the pump should not be in operation.

2.7.6. Alarm no. 7:6 "Xzone, cool alarm input 2 tripped"

The alarm is enabled when the Xzone function is activated and, depending on which alarm function is activated for alarm input 2, alarm is obtained on receiving a fault indication on the alarm input.

Optional functions: "Alarm at open contact", "Alarm at closed contact" and "Contactor function".

Fault tracing tripped alarm GOLD E			<i>Document no.</i>	<i>Revision</i>	<i>Page</i> 33 (146)
			<i>Date released</i>		<i>Supersedes</i>
<i>Type of document</i> Instruktion	<i>Drawn up by</i> Bertil Sjunnesson	<i>Revised by</i> Magnus Hallén	<i>Released and published by</i>		

Contactor function means that the alarm input must close within 3 seconds after the Pump output has been energised. The function is used when a contactor is used for controlling the pump. An alarm is also initiated if the alarm input is closed when the pump should not be in operation.

2.8. Alarm group 8: COOLING

2.8.1. Alarm no. 8:5 "Cool, valve monitoring tripped"

The alarm is only enabled when a type 9-10 chilled water coil is connected to the "Cool" connection on the IQLogic control unit and Valve monitoring has been manually activated. The alarm trips when the feedback signal (input signal) from the valve actuator does not agree with the control signal. For a 0% output signal the feedback must be < 8% and for a 100% output signal >92% so that the alarm will not trip.

For troubleshooting see Alarm no. 3:6 above.

Fault tracing tripped alarm GOLD E			Document no.	Revision	Page 34 (146)
			Date released	Supersedes	
Type of document Instruktion	Drawn up by Bertil Sjunnesson	Revised by Magnus Hallén	Released and published by		

2.9. Alarm group 10: AHU TEMPERATURE SENSOR

2.9.1. Alarm no. 10:1 "Supply air temperature sensor defective"

The alarm is always enabled. The alarms trip when the control unit does not have communication with the temperature sensor or when the sensor measures temperatures outside the range of measurement (-55°C – 125°C).

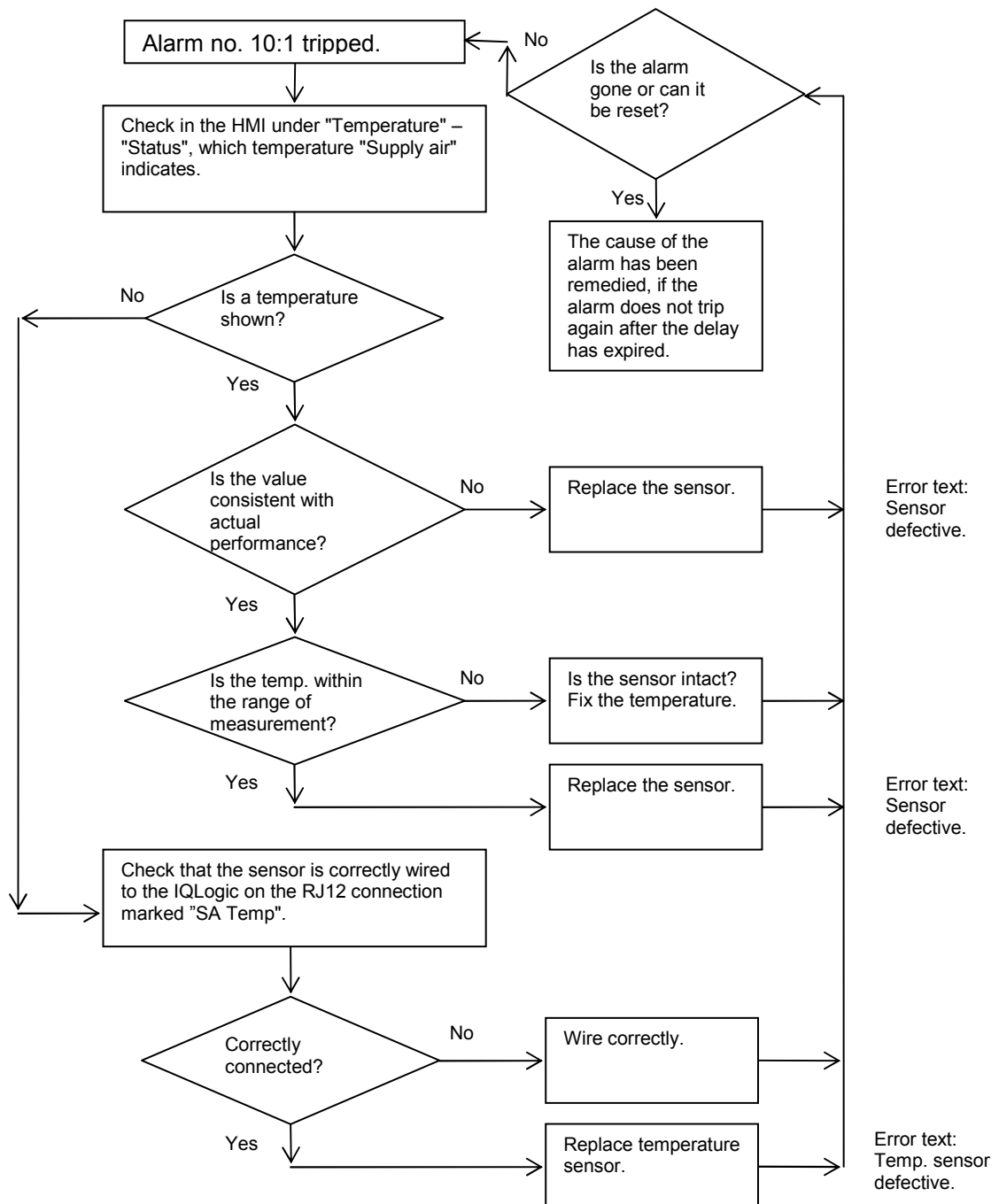

Fault tracing tripped alarm GOLD E			Document no.	Revision	Page 35 (146)
			Date released		Supersedes
Type of document Instruktion	Drawn up by Bertil Sjunnesson	Revised by Magnus Hallén	Released and published by		

2.9.2. Alarm no. 10:2 "Supply air temperature sensor for density compensation defective"

The alarm is enabled in the GOLD PX and CX, which presupposes that the sensors are connected. The alarm trips when the control unit does not have communication with the temperature sensor or when the sensor measures temperatures outside the range of measurement (-55°C – 125°C).

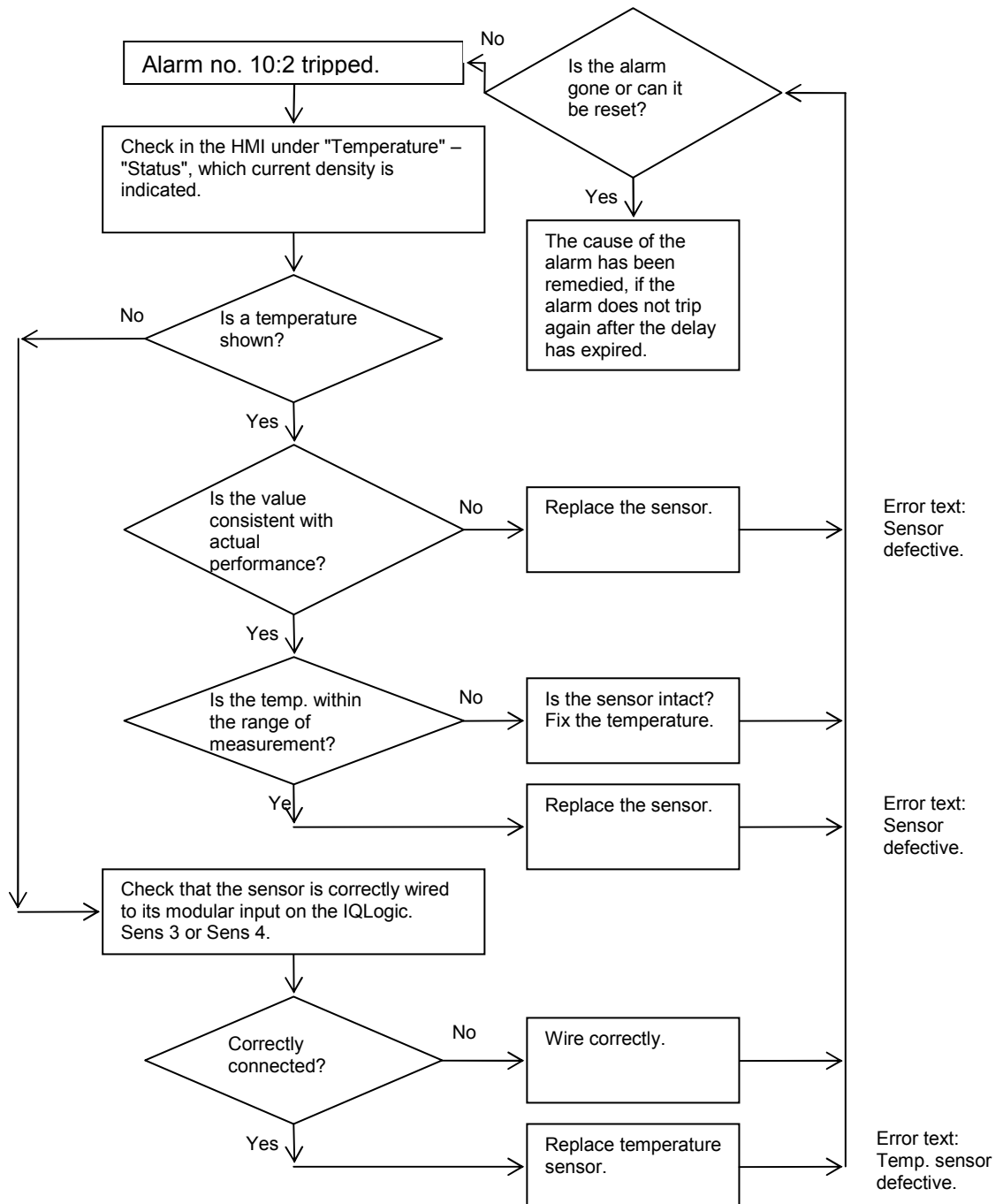

Fault tracing tripped alarm GOLD E			Document no.	Revision	Page
					36 (146)
			Date released	Supersedes	
Type of document Instruktion	Drawn up by Bertil Sjunnesson	Revised by Magnus Hallén	Released and published by		

2.9.3. Alarm no. 10:3 "Extract air temperature sensor defective"

The alarm is enabled when ERS, ORE or Extract air temperature regulation is selected. The alarms trip when the control unit does not have communication with the extract air temperature sensor in the air handling unit or when the sensor measures temperatures outside the range of measurement (-55°C – 125°C).

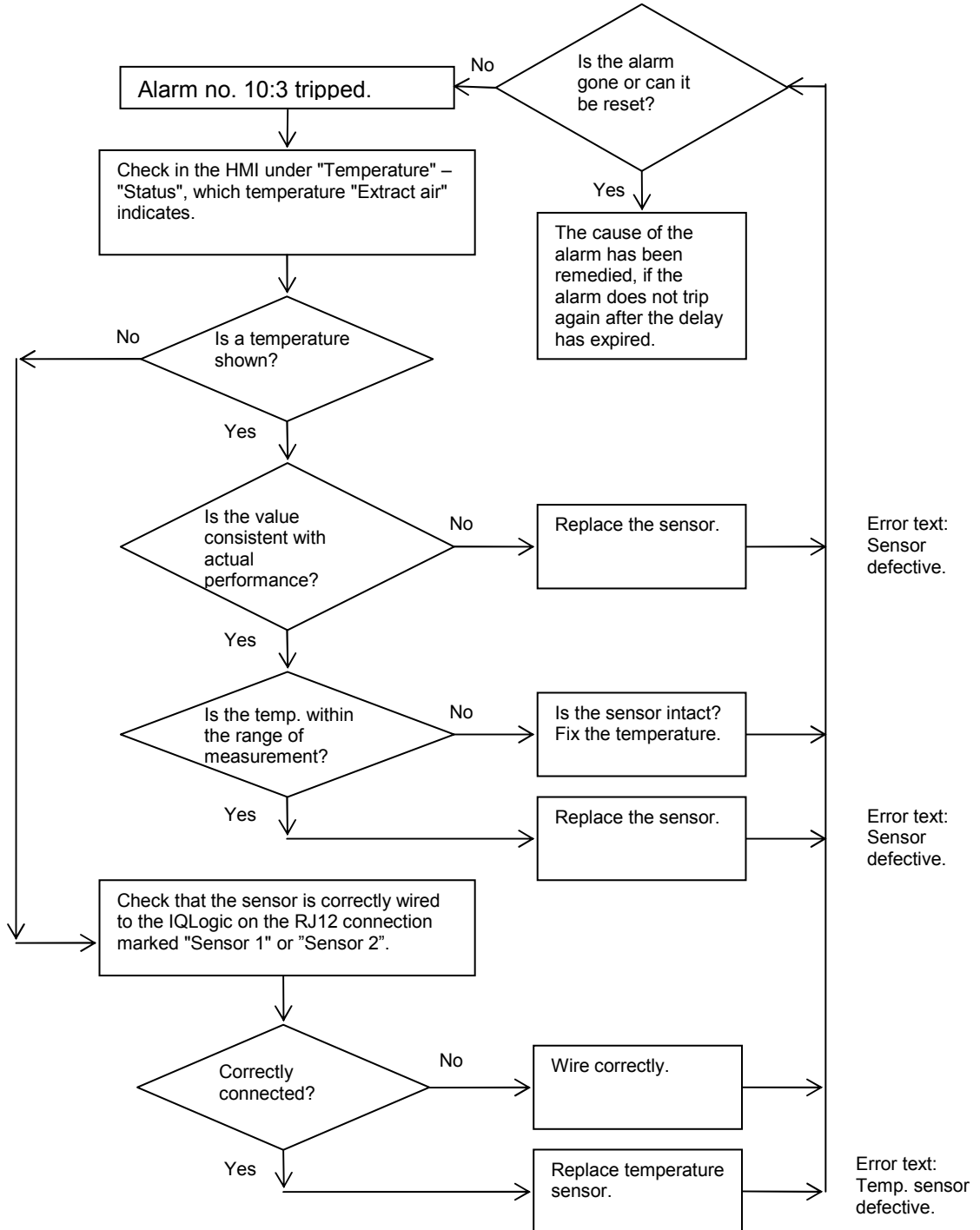

Fault tracing tripped alarm GOLD E			Document no.	Revision	Page
					37 (146)
			Date released	Supersedes	
Type of document	Drawn up by	Revised by	Released and published by		
Instruktion	Bertil Sjunnesson	Magnus Hallén			

2.9.4. Alarm no. 10:4 "Extract air temperature sensor for density compensation defective"

The alarm is enabled in the GOLD PX and CX, which presupposes that the sensors are connected. The alarm trips when the control unit does not have communication with the temperature sensor or when the sensor measures temperatures outside the range of measurement (-55°C – 125°C).

For troubleshooting see Alarm no. 10:2 above.

2.9.5. Alarm no. 10:5 "Extract air temperature sensor for defrost defective"

The alarm is enabled in the GOLD PX and CX, which presupposes that the combined Humidity/temperature sensor is connected.

The alarms trip when the control unit does not have communication with the humidity/temperature sensor in the air handling unit or when the sensor measures temperatures outside the range of measurement (-55°C – 125°C).

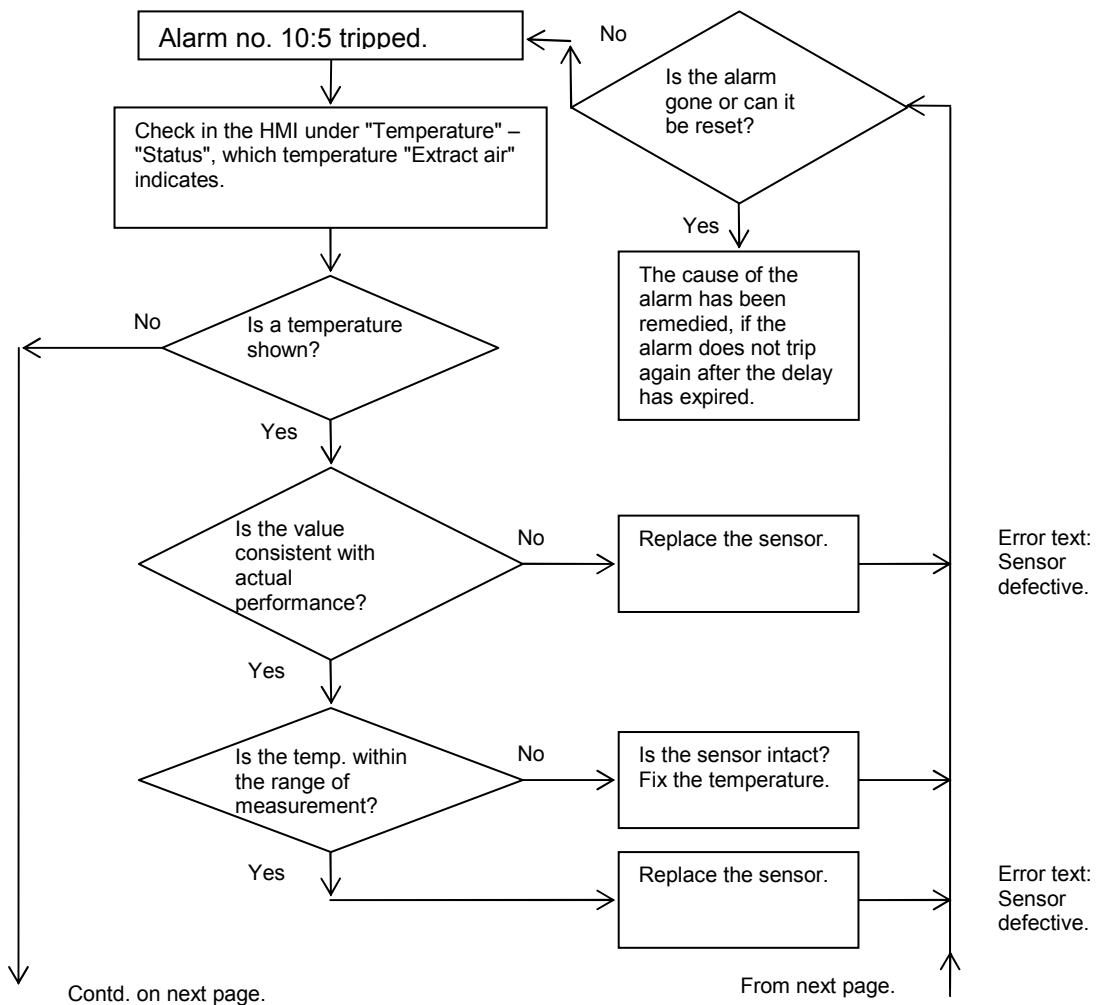

Fault tracing tripped alarm GOLD E			<i>Document no.</i>	<i>Revision</i>	<i>Page</i>
					38 (146)
			<i>Date released</i>	<i>Supersedes</i>	
<i>Type of document</i> Instruktion	<i>Drawn up by</i> Bertil Sjunnesson	<i>Revised by</i> Magnus Hallén	<i>Released and published by</i>		

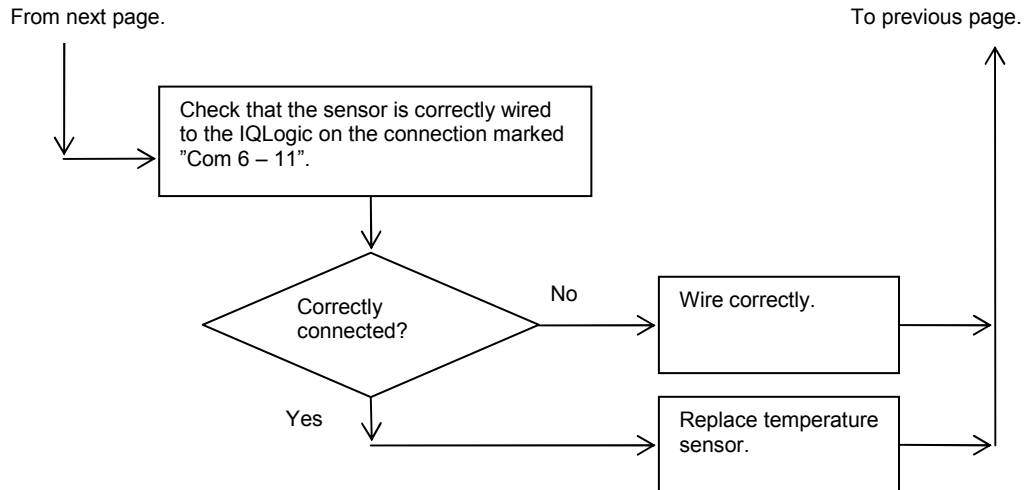

2.9.6. Alarm no. 10:6 "Extract air temperature sensor for density compensation in SD AHU defective"

The alarm is enabled for GOLD SD SA+EA air handling units, which presupposes that the extract air temperature sensor for density compensation is connected. The alarms trip when the control unit does not have communication with the humidity/temperature sensor in the air handling unit or when the sensor measures temperatures outside the range of measurement (-55°C – 125°C).

For troubleshooting see Alarm no. 10:5 above.

2.9.7. Alarm no. 10:7 "Extract air duct temperature sensor defective"

The alarm trips if the IQLogic control unit does not achieve correct communication with the extract air duct sensor.

For troubleshooting, see Alarm no. 10:5

2.9.8. Alarm no. 10:10 "Outdoor temperature sensor defective"

The alarm is always enabled. The alarms trip when the control unit does not have communication with the temperature sensor or when the sensor measures temperatures outside the range of measurement (-55°C – 125°C).

For troubleshooting see Alarm no. 10:3 above.

Fault tracing tripped alarm GOLD E			Document no.	Revision	Page
					39 (146)
			Date released	Supersedes	
Type of document	Drawn up by	Revised by	Released and published by		
Instruktion	Bertil Sjunnesson	Magnus Hallén			

2.10. Alarm group 11: AHU MIN/MAX/MEDIUM TEMPERATURE SENSORS

2.10.1. Alarm no. 11:1-4 "Room temperature sensors nos. 1 – 4 defective"

The alarms are enabled when corresponding External room sensor 1 to 4 is selected ON. The alarms trip when the control unit does not have communication with the selected room sensor or when the sensor measures temperatures outside the range of measurement (-55°C – 125°C). The room sensor's address selector switch must be set to the corresponding number 1-4.

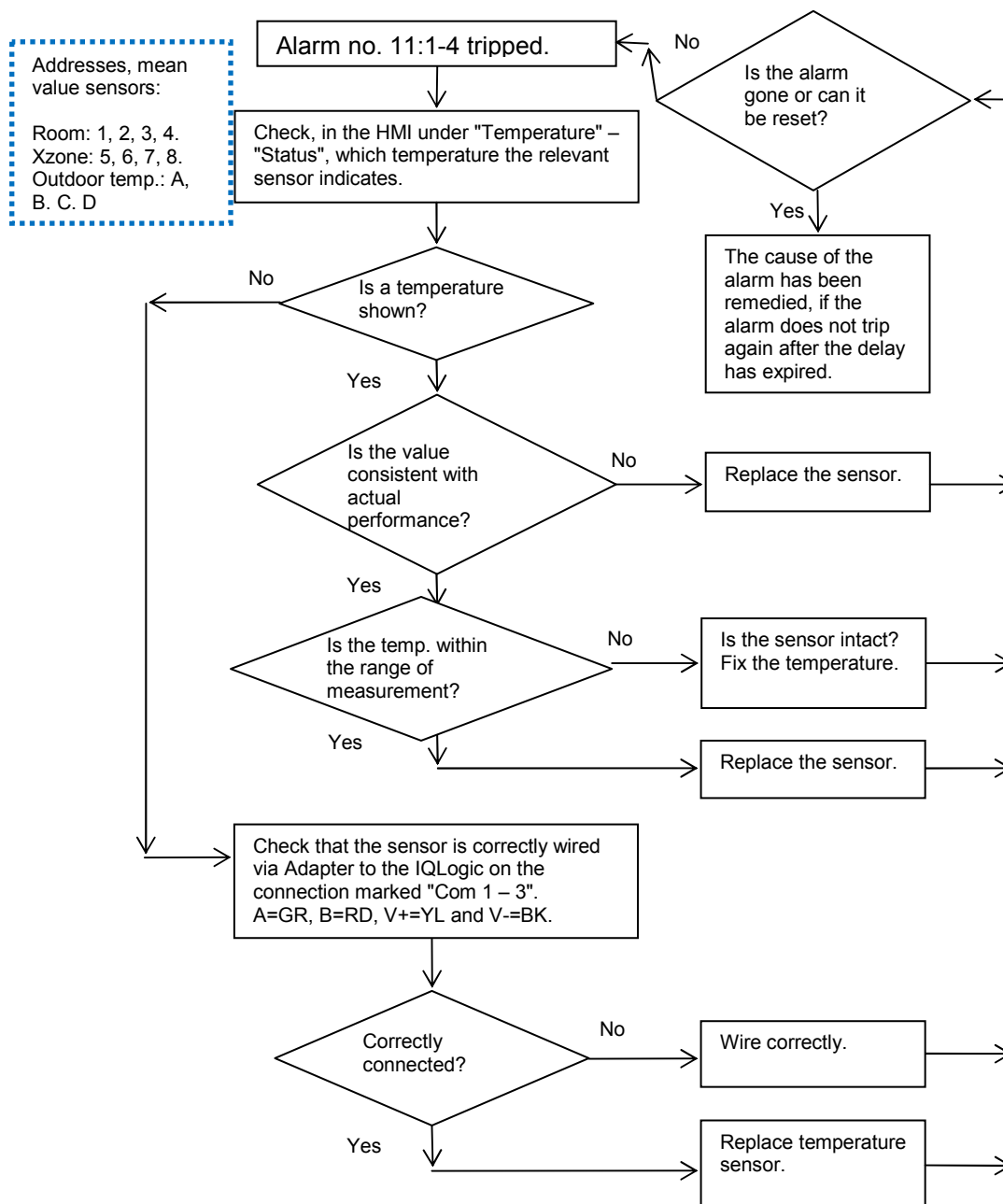

Fault tracing tripped alarm GOLD E			<i>Document no.</i>	<i>Revision</i>	<i>Page</i>
					40 (146)
			<i>Date released</i>	<i>Supersedes</i>	
<i>Type of document</i>	<i>Drawn up by</i>	<i>Revised by</i>	<i>Released and published by</i>		
Instruktion	Bertil Sjunnesson	Magnus Hallén			

2.10.2. Alarm no. 11:5-8 "Xzone, room temperature sensors nos. 5 - 8 defective"

The alarms are enabled when corresponding Xzone room sensors 5 to 8 are selected On. The alarms trip when the control unit does not have communication with the selected Xzone room sensor or when the sensor measures temperatures outside the range of measurement (-55°C – 125°C). The Xzone room sensor's address selector switch must be set to the corresponding number 5-8.

For troubleshooting see Alarm nos. 11:1-4 above.

2.10.3. Alarm nos. 11:9 – 12 "Outdoor temperature sensors A – D defective"

The alarms are enabled when corresponding External outdoor air sensor A to D is selected ON. The alarms trip when the control unit does not have communication with the selected outdoor air sensor or when the sensor measures temperatures outside the range of measurement (-55°C – 125°C). The External outdoor sensor's address selector switch must be set to the corresponding number 5-8.

For troubleshooting see Alarm nos. 11:1-4 above.

2.10.4. Alarm no. 11:13 "Room temperature via communication, communication error"

The alarm is enabled when the External temperature sensor, Room temperature from communication, is selected ON. The alarm trips when the control unit does not receive new room temperature readings via communication or when the transmitted temperature readings are outside the range of measurement (-55°C – 125°C). A new value via communication must be received within 300 seconds, otherwise the alarm will trip.

Check in the HMI under "Temperature" – "Status", that a correct "Regulation summation, extract air" reading is shown.

If 0.0°C is shown, there is probably a problem with communication so that no value is transmitted.

2.10.5. Alarm no. 11:14 "Xzone, room temperature via communication, communication error"

The alarm is enabled when the External temperature sensor, Xzone, room temperature from communication, is selected ON.

The alarm trips when the control unit does not receive new room temperature readings via communication or when the transmitted temperature readings are outside the range of measurement (-55°C – 125°C).

A new value via communication must be received within 300 seconds, otherwise the alarm will trip.

Check in the HMI under "Temperature" – "Status", that a correct "Regulation summation, Xzone, extract air" reading is shown.

If 0.0°C is shown, there is probably a problem with communication so that no value is transmitted.

2.10.6. Alarm no 11:15 "Outdoor temperature via communication, communication error"

The alarm is enabled when the External temperature sensor, Outdoor temperature from communication, is selected On. The alarm trips when the control unit does not receive new room temperature readings via communication or when the transmitted temperature readings are outside the range of measurement (-55°C – 125°C). A new value via communication must be received within 300 seconds, otherwise the alarm will trip.

Fault tracing tripped alarm GOLD E			<i>Document no.</i>	<i>Revision</i>	<i>Page</i>
					41 (146)
			<i>Date released</i>	<i>Supersedes</i>	
<i>Type of document</i>	<i>Drawn up by</i>	<i>Revised by</i>	<i>Released and published by</i>		
Instruktion	Bertil Sjunnesson	Magnus Hallén			

Check in the HMI under "Temperature" – "Status", that a correct "Regulation summation, outdoor air" reading is shown.

If 0.0°C is shown, there is probably a problem with communication so that no value is transmitted.

2.11. Alarm group 12: AHU TEMPERATURE DEVIATION

2.11.1. Alarm no. 12:1 "Supply air temperature below set point".

The alarm is always enabled.

The alarms trip when the supply air temperature is below the relevant set point for more than 20 minutes.

Check in the HMI under "Alarm priority", that the temperature alarm limit is appropriate.

For troubleshooting see Alarm no. 6:7 above.

2.11.2. Alarm no. 12:2 "Supply air temperature above set point".

The alarm is always enabled.

The alarms trip when the supply air temperature is above the relevant set point for more than 20 minutes.

Check in the HMI under "Alarm priority", that the temperature alarm limit is appropriate.

For troubleshooting see Alarm no. 6:8 above.

2.11.3. Alarm no. 12:6 "Extract air temperature below alarm limit"

The alarm is always enabled.

The alarms trip when the extract air temperature is below the preset alarm limit for more than 20 minutes.

Check in the HMI, under "Alarm priority" – "Temperature, alarm limits" that "Extract air below alarm limit" is preset to the appropriate alarm limit.

Check the reason why the extract air temperature is too low.

2.11.4. Alarm no. 12:11 "Temperature monitor below alarm limit"

The alarm is enabled when the Temperature monitor function is activated under "Alarm priority".

The alarms trip when the "Supply air, density" temperature is below the preset alarm limit for more than the preset delay.

Check in the HMI under "Alarm priority" – "Temperature monitor", which alarm limit is preset.

Check the reason why the extract air temperature is too low.

2.12. Alarm group 13: HUMIDITY / VOC

2.12.1. Alarm no. 13:1 "Humidification, I/O module no. 4 communication error"

The alarm for IQLogic+ module 4 is enabled when some Humidification function is activated.

The alarm trips if the control unit does not achieve correct communication with the module.

For troubleshooting see Alarm no. 3:1 above.

Fault tracing tripped alarm GOLD E			<i>Document no.</i>	<i>Revision</i>	<i>Page</i>
					42 (146)
			<i>Date released</i>	<i>Supersedes</i>	
<i>Type of document</i>	<i>Drawn up by</i>	<i>Revised by</i>	<i>Released and published by</i>		
Instruktion	Bertil Sjunnesson	Magnus Hallén			

2.12.2. Alarm no. 13:12 "VOC sensor internal communication error"

The alarm of the VOC sensor is enabled when the "VOC sensor" function is activated.

The alarm trips if the VOC sensor does not achieve correct communication with the VOC measurement element via its internal communication.

Replace the sensor.

2.12.3. Alarm no. 13:13 "VOC sensor, internal error"

The alarm is enabled when the "VOC sensor" function is activated and the sensor reports, via communication, that it has an internal error.

Disconnect the VOC sensor for 1 minute to reset the internal alarm.

If the alarm remains, replace the VOC sensor.

2.12.4. Alarm no. 13:14 "VOC sensor, level below/above set point alarm limit"

The alarm is enabled when the "VOC sensor" function is activated and the VOC level (ppm) exceeds or is below the preset limits in the HMI under "air handing – VOC".

2.12.5. Alarm no. 13:2 "Supply air humidity sensor defective"

The alarm is enabled when the Humidification 0-10V, Dehumidification or "SA sensor only" is selected active. The alarms trip when the control unit does not obtain communication with the supply air humidity sensor.

Fault tracing tripped alarm GOLD E			Document no.	Revision	Page
					43 (146)
			Date released	Supersedes	
Type of document Instruktion	Drawn up by Bertil Sjunnesson	Revised by Magnus Hallén	Released and published by		

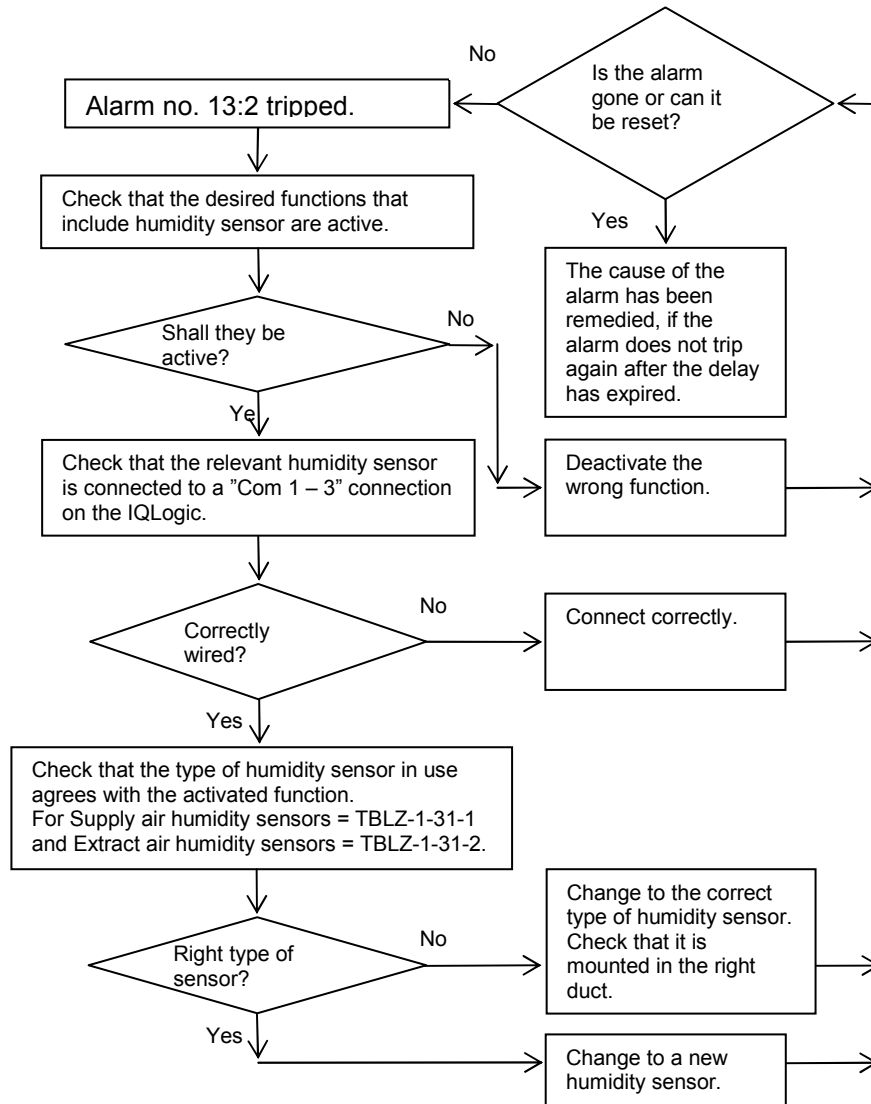

2.12.6. Alarm no. 13:3 "Extract air humidity sensor defective"

The alarms are enabled when the "EA Humidification", "AYC Cool, dew point compensation" or "EA sensor only" is selected active.

The alarms trip when the control unit does not obtain communication with the extract air humidity sensor.

For troubleshooting see Alarm no. 13:2 above.

2.12.7. Alarm no. 13:9 "Humidifier, alarm output tripped"

The alarm is enabled when the Humidification alarm functions are selected for any of the "Alarm on open circuit", "Alarm on closed circuit" or "Contactor function" functions.

The humidification alarm becomes optional when the Humidification function is selected as On/off or 0-10V.

Fault tracing tripped alarm GOLD E			<i>Document no.</i>	<i>Revision</i>	<i>Page</i>
					44 (146)
			<i>Date released</i>	<i>Supersedes</i>	
<i>Type of document</i>	<i>Drawn up by</i>	<i>Revised by</i>	<i>Released and published by</i>		
Instruktion	Bertil Sjunnesson	Magnus Hallén			

The alarms trip when the input on IQLogic+ module 4, is "Open", "Closed" or when contactor feedback is not received.

Check the function on the external connection.

2.12.8. Alarm no. 13:11 "VOC sensor communication error"

The alarm of the VOC sensor is enabled when the "VOC sensor" function is activated.
The alarm trips if the control unit does not achieve correct communication with the module.

The VOC sensor shall be connected to "Com 1 – 3" on the IQLogic control unit.
If the malfunction remains, with correctly connected sensor, replace the VOC sensor

2.12.9. Alarm no. 13:12 "VOC sensor defective"

The alarm is enabled when the "VOC sensor" function is activated and the sensor reports, via communication, that it has an internal malfunction.

Disconnect the VOC sensor for one minute to reset the internal alarm.
If the alarm remains, replace the VOC sensor.

Fault tracing tripped alarm GOLD E			Document no.	Revision	Page 45 (146)
			Date released	Supersedes	
Type of document Instruktion	Drawn up by Bertil Sjunnesson	Revised by Magnus Hallén	Released and published by		

2.13. Alarm group 15: PLATE HEAT EXCHANGER

2.13.1. Alarm no. 15:1 "Plate heat exchanger, I/O module no. 2 communication error"

The alarm of IQLogic+ module 2 (S) is enabled when the GOLD PX unit is selected. The alarm trips if the control unit does not achieve correct communication with the module.

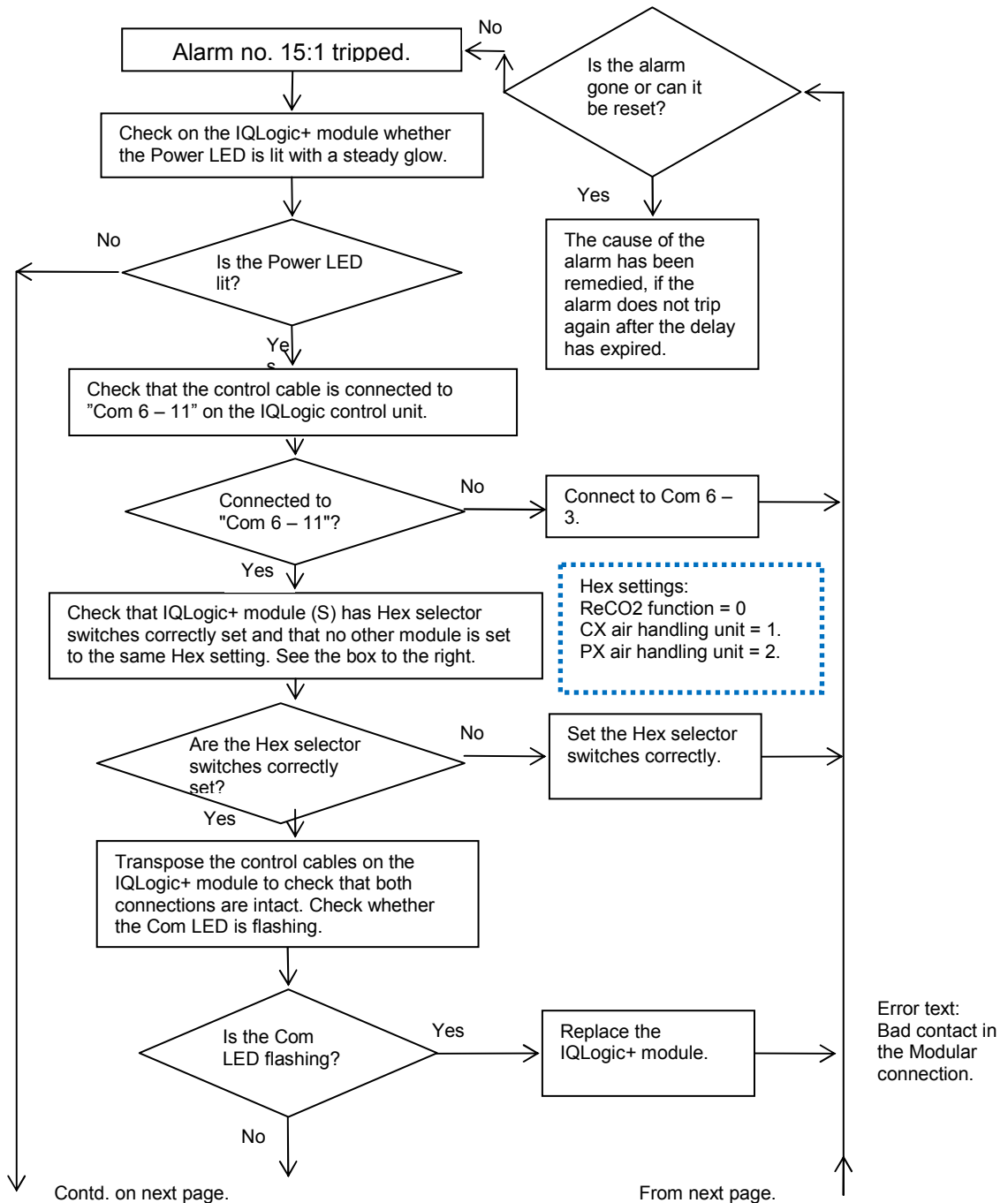

Fault tracing tripped alarm GOLD E			<i>Document no.</i>	<i>Revision</i>	<i>Page</i>
					46 (146)
			<i>Date released</i>	<i>Supersedes</i>	
<i>Type of document</i> Instruktion	<i>Drawn up by</i> Bertil Sjunnesson	<i>Revised by</i> Magnus Hallén	<i>Released and published by</i>		

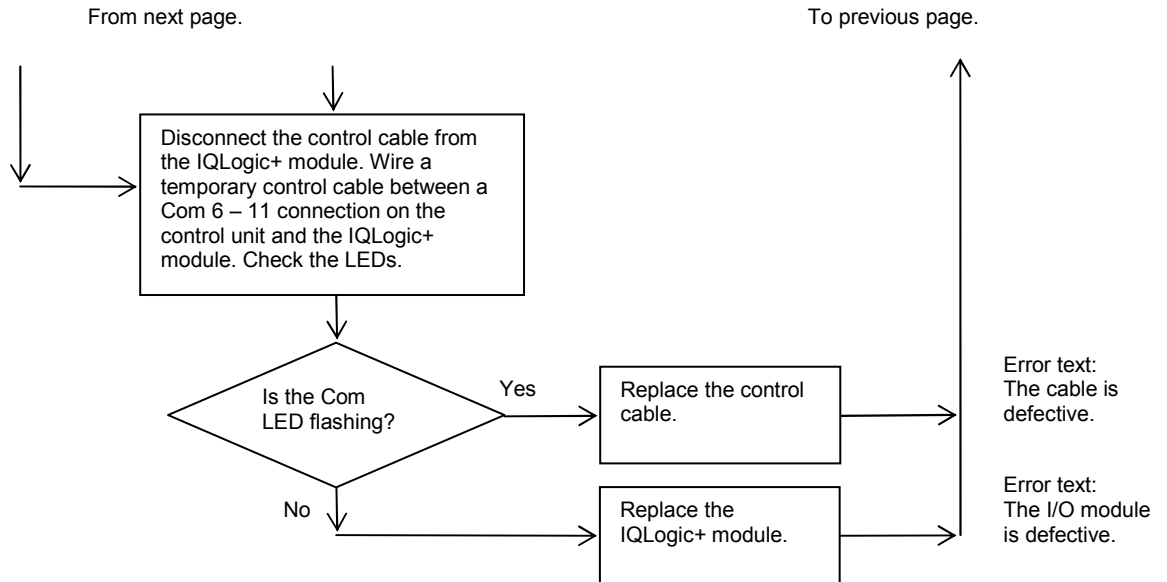

Fault tracing tripped alarm GOLD E			Document no.	Revision	Page
					47 (146)
			Date released	Supersedes	
Type of document	Drawn up by	Revised by	Released and published by		
Instruktion	Bertil Sjunnesson	Magnus Hallén			

2.13.2. Alarm no. 15:2-3 "Plate heat exchanger temp. sensor no. 1-2 defective"

The alarms are enabled when a GOLD PX unit is selected.

The alarms trip when the control unit does not have communication with the corresponding frost guard temperature sensor in the heat exchanger cube or when the sensor measures temperatures outside the range of measurement (-55°C – 125°C).

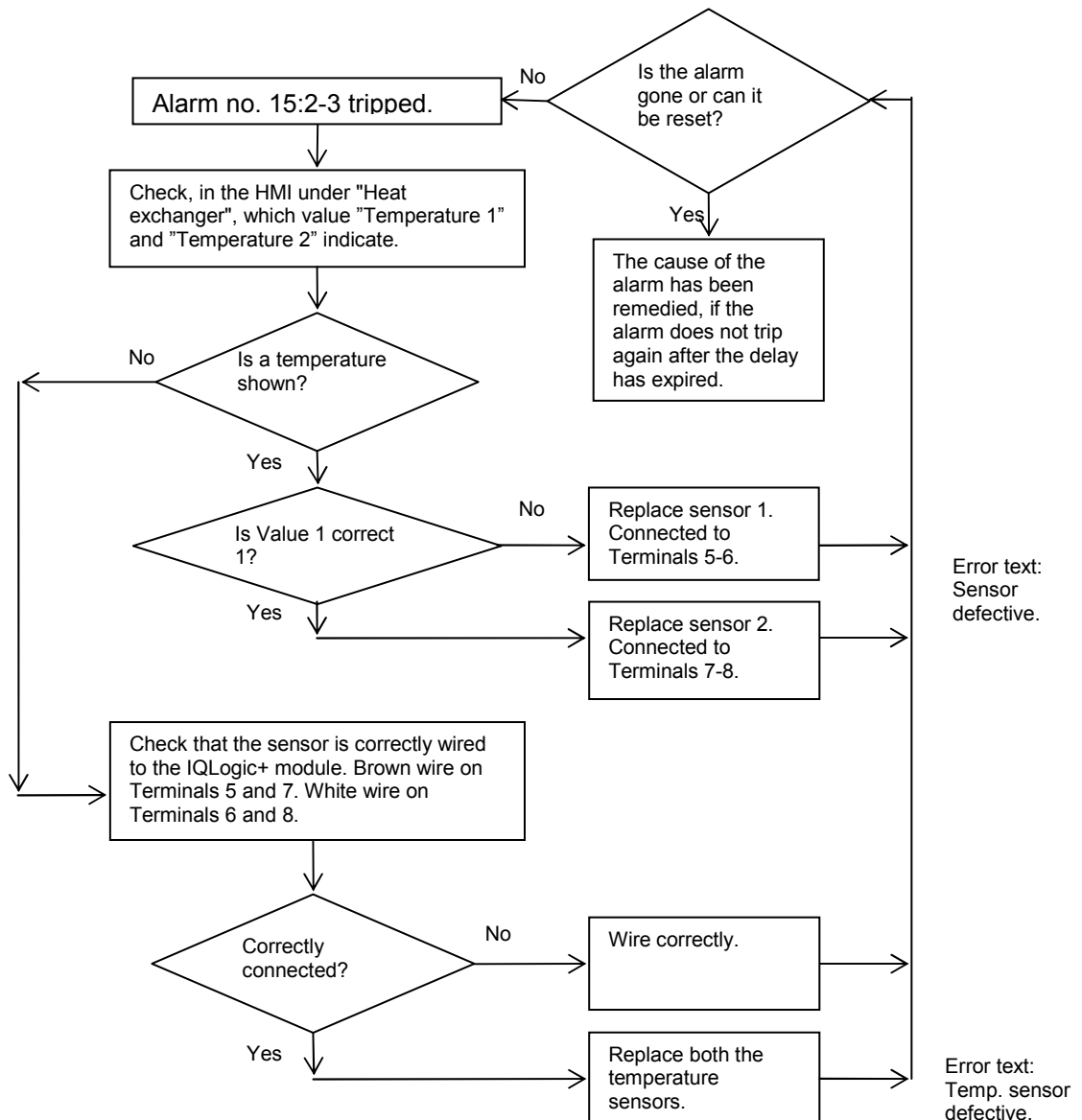

Fault tracing tripped alarm GOLD E			Document no.	Revision	Page 48 (146)
			Date released	Supersedes	
Type of document Instruktion	Drawn up by Bertil Sjunnesson	Revised by Magnus Hallén	Released and published by		

2.13.3. Alarm no. 15:4 "Plate heat exchanger, damper monitoring tripped"

The alarms are enabled when a GOLD PX unit is selected.

The alarm trips when the feedback signal (input signal) from the bypass damper motor does not agree with the control signal.

The alarm trips If the control signal is 0-2% and the feedback signal is > 8% and if the control signal is 97-100% and the feedback signal is < 92%.

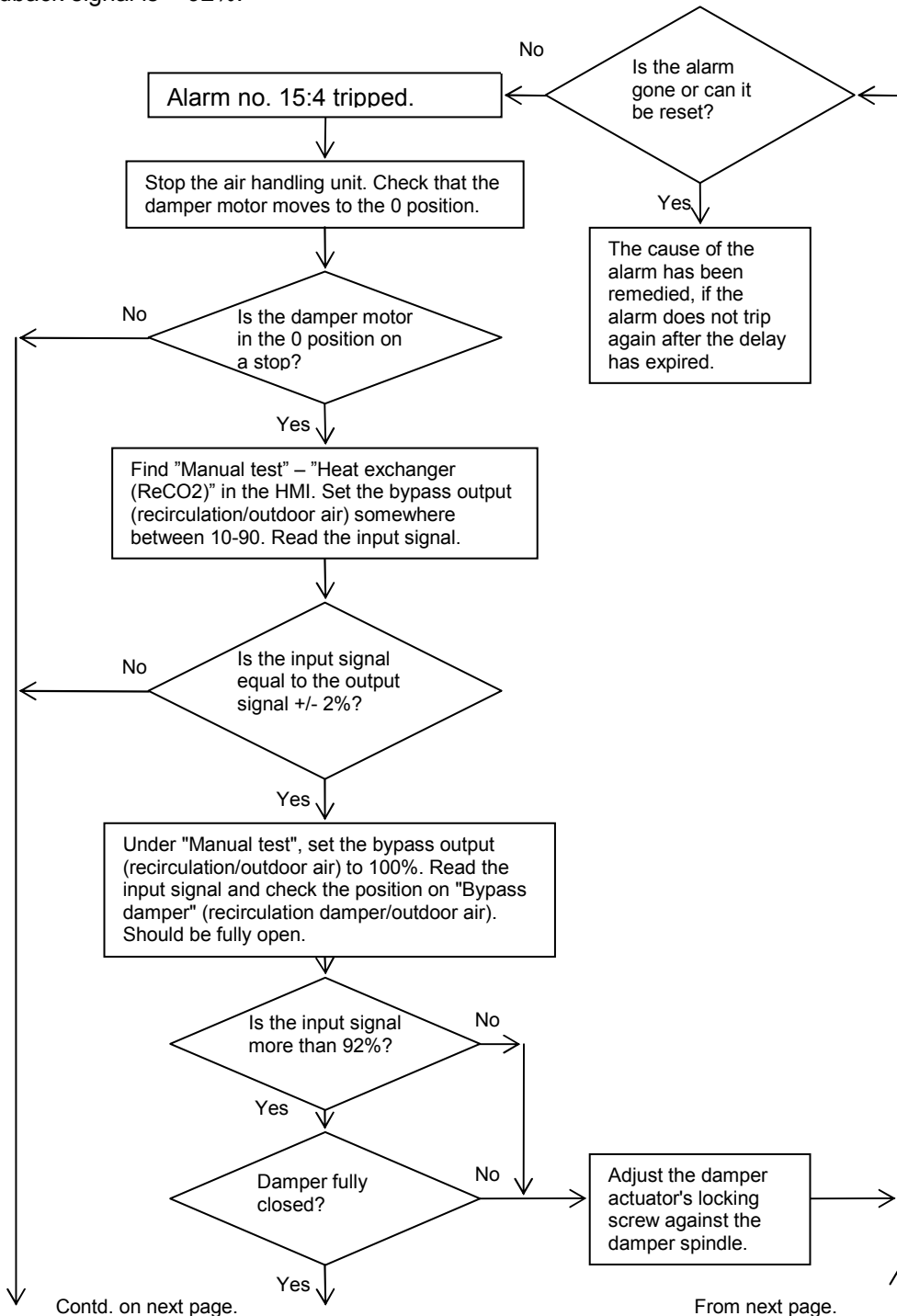

Fault tracing tripped alarm GOLD E			Document no.	Revision	Page
					49 (146)
			Date released	Supersedes	
Type of document Instruktion	Drawn up by Bertil Sjunnesson	Revised by Magnus Hallén	Released and published by		

From next page.

To previous page.

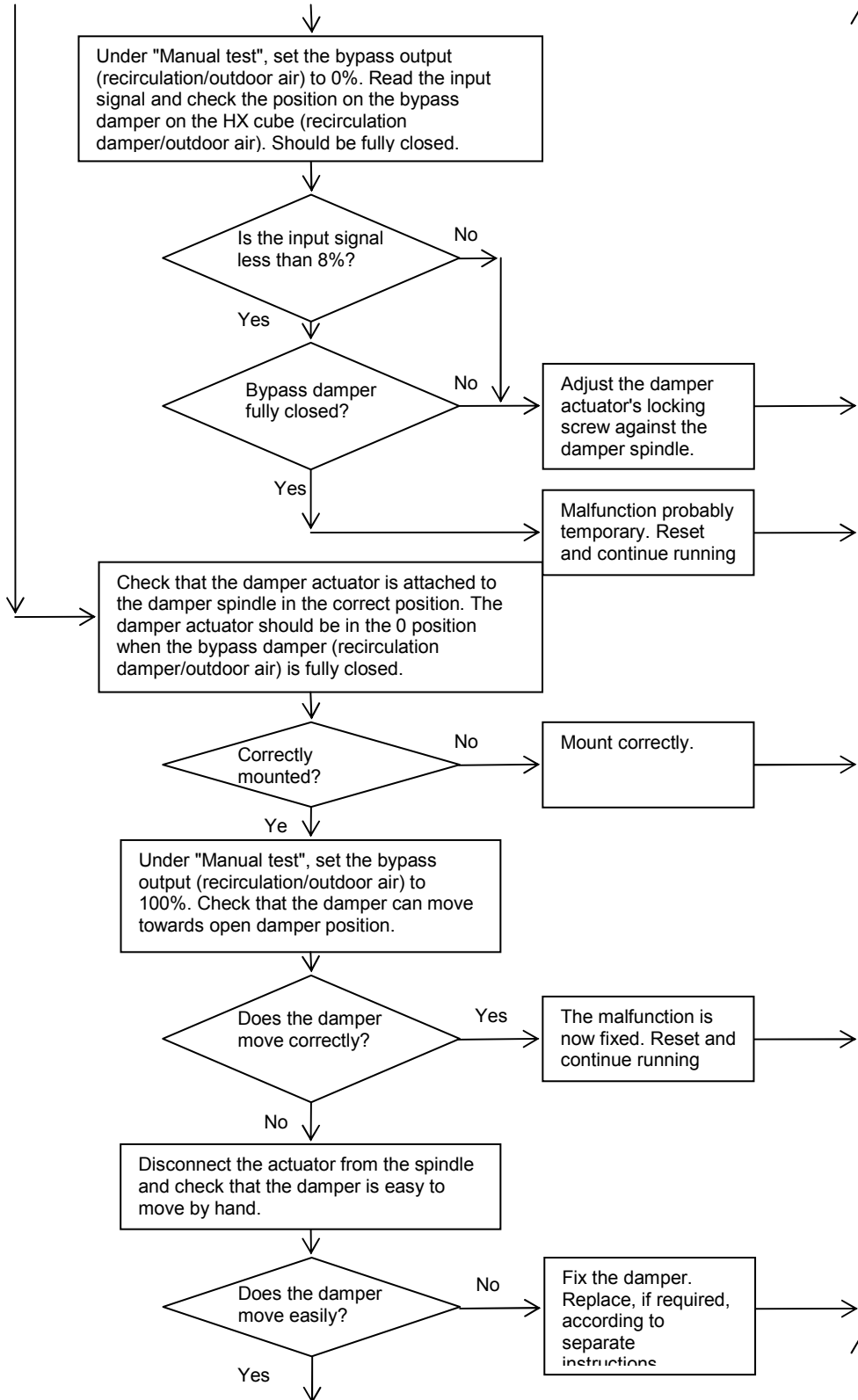

Contd. on next page.

From next page.

Fault tracing tripped alarm GOLD E			Document no.	Revision	Page
					50 (146)
Type of document		Drawn up by	Revised by	Released and published by	
Instruktion		Bertil Sjunnesson	Magnus Hallén		
Date released			Supersedes		

From next page.

To previous page.

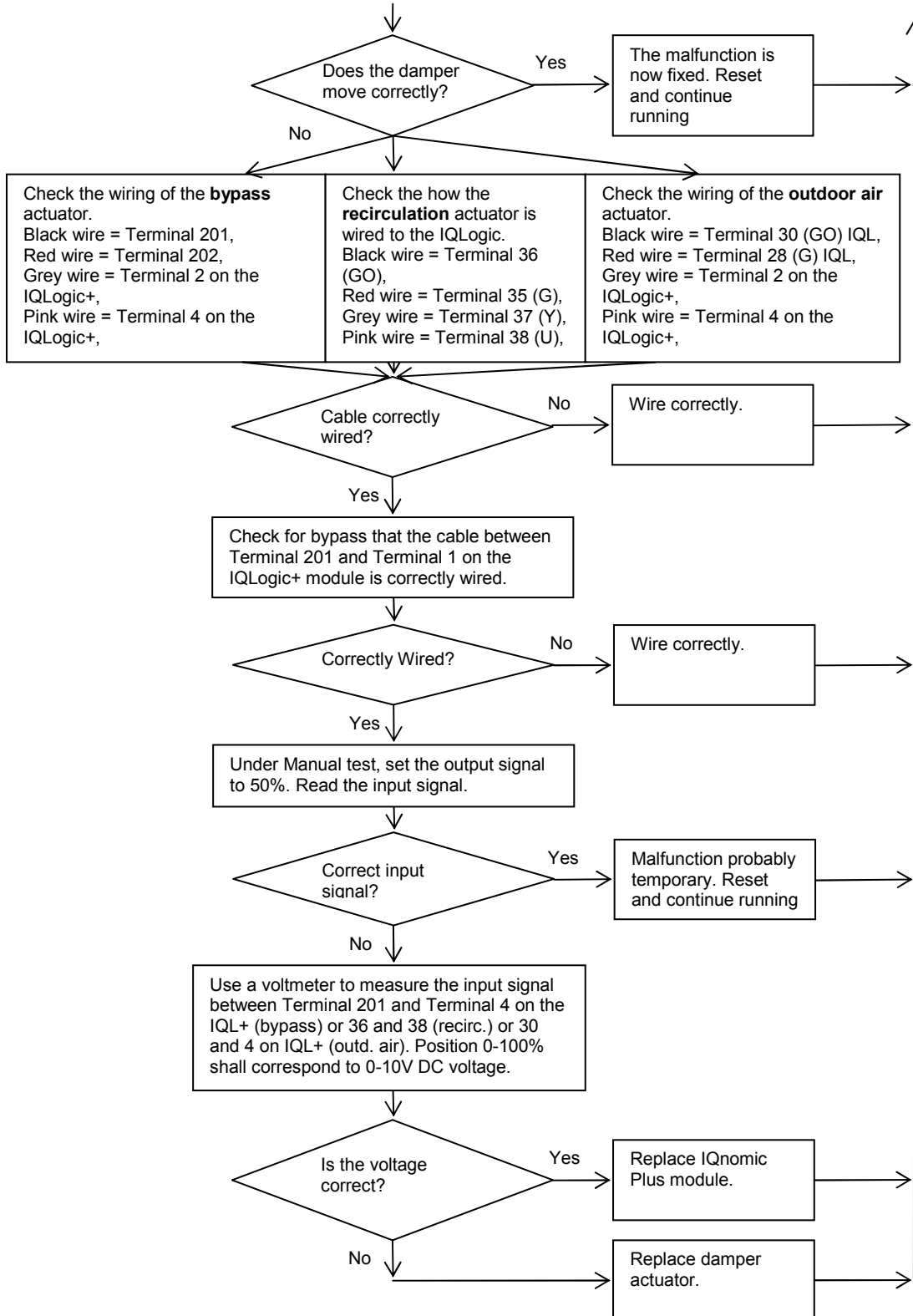

Fault tracing tripped alarm GOLD E			<i>Document no.</i>	<i>Revision</i>	<i>Page</i>
					51 (146)
			<i>Date released</i>	<i>Supersedes</i>	
<i>Type of document</i>	<i>Drawn up by</i>	<i>Revised by</i>	<i>Released and published by</i>		
Instruktion	Bertil Sjunnesson	Magnus Hallén			

2.13.4. Alarm no. 15:7 "Plate heat exchanger, I/O module no. 3 communication error"

The alarm is enabled when a GOLD PX unit with RECO Frost defrosting function is selected.
The alarm trips if the control unit does not achieve correct communication with IQlogic+ module no. 3.

For troubleshooting, see Alarm no. 15:1

2.13.5. Alarm no. 15:8 "Plate heat exchanger, Bypass damper monitoring tripped"

The alarm is enabled when a GOLD PX unit with RECO Frost defrost function is selected, damper monitoring is selected as active and the signal feedback does not indicate correct position.
The alarm trips if the output signal is less than 3% and the feedback is more than 15% or if the output signal is more than 97% and the feedback is less than 85%.

On an output signal of 10Vdc on Terminal 4 on the IQlogic+ module the bypass damper is fully open.

For troubleshooting, see Alarm no. 15:4

2.13.6. Alarm no. 15:9 "Plate heat exchanger, Damper no. 1 monitoring tripped"

The alarm is enabled when a GOLD PX unit with RECO Frost defrost function is selected, damper monitoring is selected as active and the signal feedback does not indicate correct position.
The alarm trips if the output signal is less than 3% and the feedback is more than 15% or if the output signal is more than 97% and the feedback is less than 85%.

On an output signal of 10Vdc on Terminal 8 on the IQlogic+ module the damper is fully closed.

For troubleshooting, see Alarm no. 15:4

2.13.7. Alarm no. 15:10 "Plate heat exchanger, Damper no. 2 monitoring tripped"

The alarm is enabled when a GOLD PX unit with RECO Frost defrost function is selected, damper monitoring is selected as active and the signal feedback does not indicate correct position.
The alarm trips if the output signal is less than 3% and the feedback is more than 15% or if the output signal is more than 97% and the feedback is less than 85%.

On an output signal of 10Vdc on Terminal 6 on the IQlogic+ module the damper is fully closed.

For troubleshooting, see Alarm no. 15:4

2.13.8. Alarm no. 15:11 "Plate heat exchanger, I/O module no. 3 communication error"

The alarm is enabled when a GOLD PX unit with "standard pressure" defrost function is selected.
The alarm trips if the control unit does not achieve correct contact with IQlogic+ module no. 3.

For troubleshooting, see Alarm no. 3:1

Fault tracing tripped alarm GOLD E			<i>Document no.</i>	<i>Revision</i>	<i>Page</i> 52 (146)
			<i>Date released</i>		<i>Supersedes</i>
<i>Type of document</i> Instruktion	<i>Drawn up by</i> Bertil Sjunnesson	<i>Revised by</i> Magnus Hallén	<i>Released and published by</i>		

2.13.9. Alarm no. 15:12 "Plate heat exchanger, Bypass damper monitoring tripped"

The alarm is enabled when the GOLD PX unit with Standard pressure defrost function is selected, damper monitoring is selected as active and the signal feedback does not indicate correct position.

The alarm trips if the output signal is less than 3% and the feedback is more than 15% or if the output signal is more than 97% and the feedback is less than 85%.

For troubleshooting, see Alarm no. 15:4

Fault tracing tripped alarm GOLD E			Document no.	Revision	Page
					53 (146)
Type of document		Drawn up by	Revised by	Released and published by	
Instruktion		Bertil Sjunnesson	Magnus Hallén		

2.13.10. Alarm no. 15:14 "Plate heat exchanger, defrost pressure sensor no. C communication error"

The alarm is enabled when a GOLD PX unit with RECO Frost or Standard pressure defrost function is selected. The alarm trips if the control unit does not achieve correct communication with the HEX C pressure sensor.

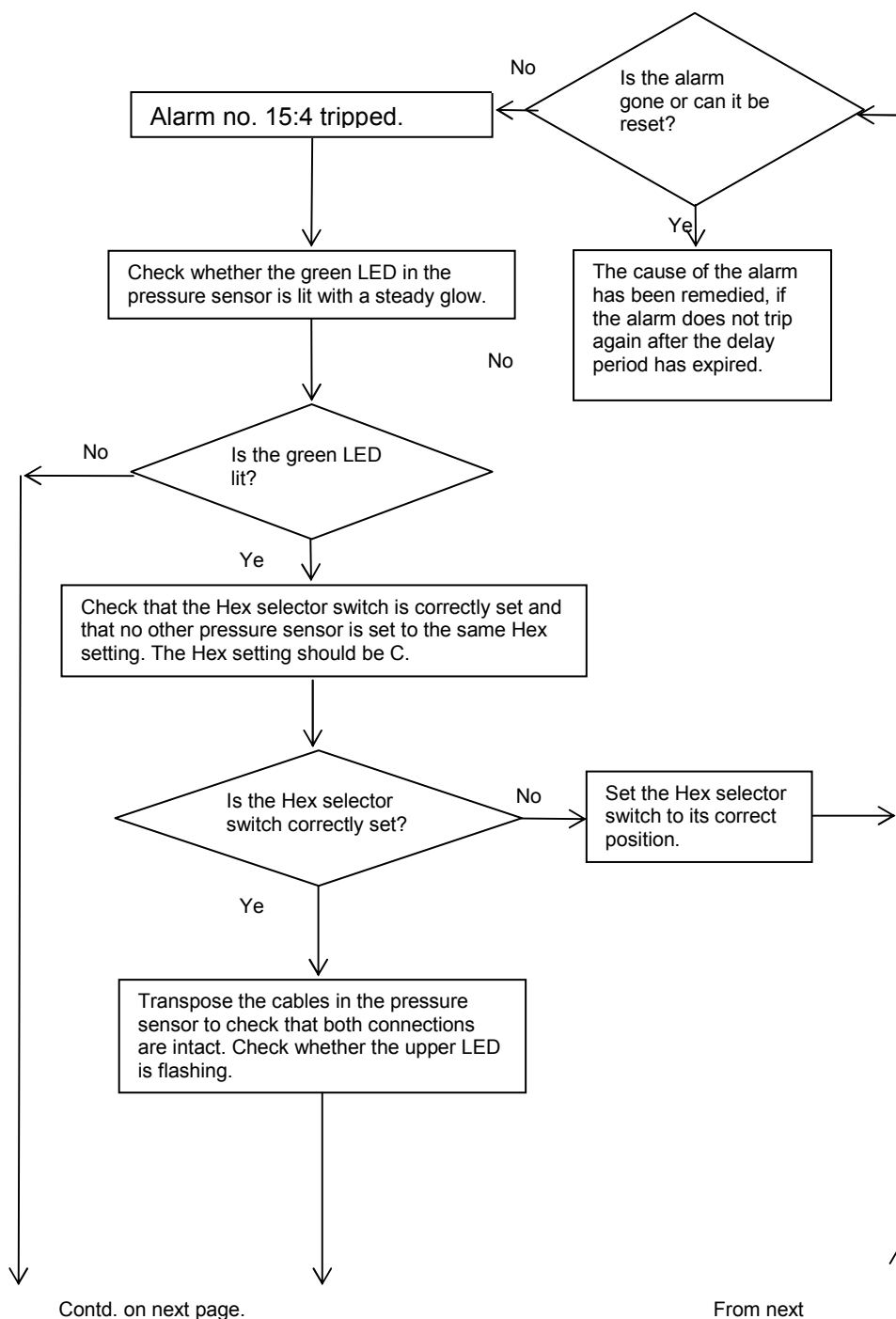

Fault tracing tripped alarm GOLD E			<i>Document no.</i>	<i>Revision</i>	<i>Page</i>
					54 (146)
			<i>Date released</i>	<i>Supersedes</i>	
<i>Type of document</i> Instruktion	<i>Drawn up by</i> Bertil Sjunnesson	<i>Revised by</i> Magnus Hallén	<i>Released and published by</i>		

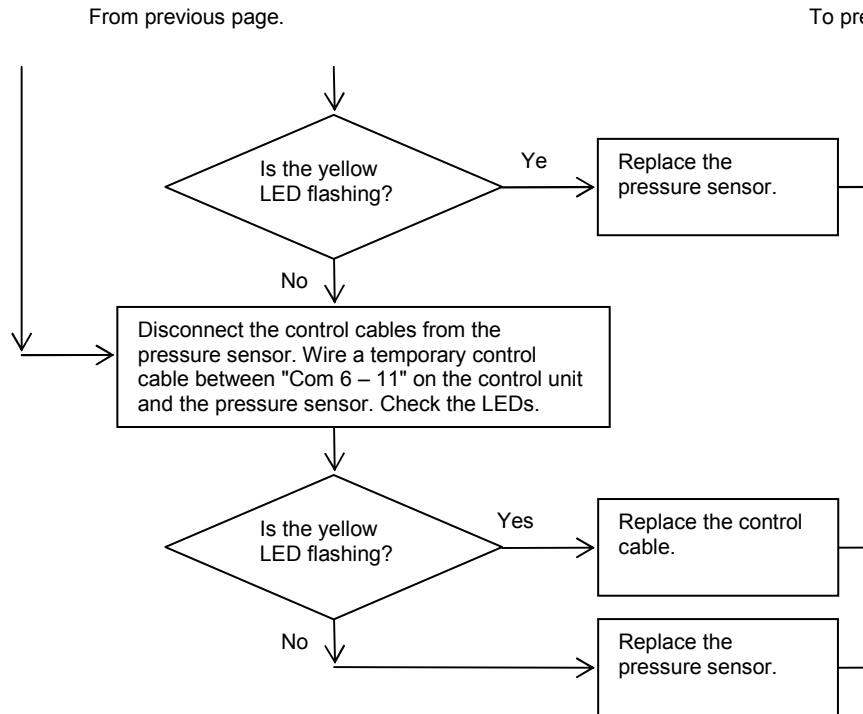

Fault tracing tripped alarm GOLD E			<i>Document no.</i>	<i>Revision</i>	<i>Page</i>
					55 (146)
			<i>Date released</i>	<i>Supersedes</i>	
<i>Type of document</i>	<i>Drawn up by</i>	<i>Revised by</i>	<i>Released and published by</i>		
Instruktion	Bertil Sjunnesson	Magnus Hallén			

2.13.11. Alarm no. 15:15 "Plate heat exchanger, defrost pressure above alarm limit"

The alarm is enabled when a GOLD PX unit with RECO Frost or Standard pressure defrost function is selected. The alarm trips if the defrost pressure exceeds the preset value in the HMI under "Heat exchanger – bypass – defrost".

For troubleshooting, see Alarm no. 17:3

Alarm group 16: COIL HEAT EXCHANGER

2.13.12. Alarm no. 16:1 "Coil heat exchanger, I/O module no. 1 communication error"

The alarm of IQLogic+ module 1 (S) is enabled when the GOLD CX unit is selected. The alarm trips if the control unit does not achieve correct communication with the module. For troubleshooting see Alarm no. 15:1 above.

2.13.13. Alarm no. 16:2 "Coil heat exchanger, temperature sensor defective"

The alarm is enabled when a GOLD CX unit is selected. The alarms trip when the control unit does not have communication with the frost protection temp. sensor on the return pipe or when the sensor measures temperatures outside the range of measurement (-55°C – 125°C).

Fault tracing tripped alarm GOLD E			Document no.	Revision	Page
					56 (146)
			Date released	Supersedes	
Type of document Instruktion	Drawn up by Bertil Sjunnesson	Revised by Magnus Hallén	Released and published by		

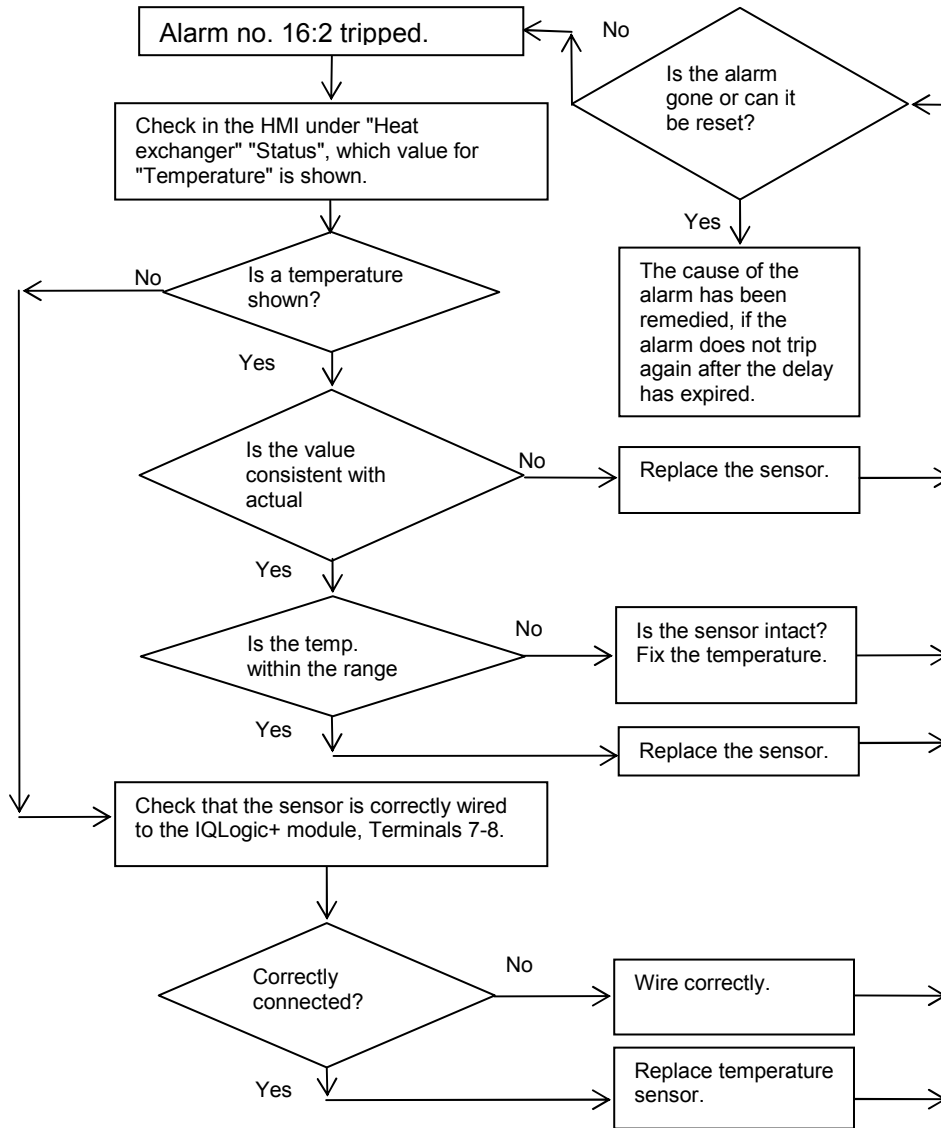

Fault tracing tripped alarm GOLD E			<i>Document no.</i>	<i>Revision</i>	<i>Page</i> 57 (146)
			<i>Date released</i>		<i>Supersedes</i>
<i>Type of document</i> Instruktion	<i>Drawn up by</i> Bertil Sjunnesson	<i>Revised by</i> Magnus Hallén	<i>Released and published by</i>		

2.13.14. Alarm no. 16:3 "Coil heat exchanger, valve monitoring tripped"

The alarm is enabled when a GOLD CX unit is selected and valve monitoring is activated..

The alarm trips when the feedback signal (input signal) from the valve actuator does not agree with the control signal.

For a 0-2% output signal the feedback must be < 8% and for a 97-100% output signal >92% so that the alarm will not trip.

For troubleshooting see Alarm no. 3:6 above.

2.13.15. Alarm no. 16:4 "Coil heat exchanger, pump monitoring tripped"

The alarm is enabled when a GOLD CX unit is selected and pump alarm is activated.

The following alarm functions are available: "Alarm on closed contact" (factory setting), "Alarm on open contact" and "Contactor function".

The alarm trips when the alarm input on Terminals 11-12 on the IQLogic+ module meet the necessary conditions for the selected alarm.

For GOLD CX units with **DAB pump**, controlled with an On/off signal transmitted directly to the pump, from Terminals 9-10 on the IQLogic+ module.

The pump has an internal common fault alarm wired to Terminals 11-12 on the IQLogic+ module.

- Check that the safety switch of the circulation pump is in switched on.
- Check that the alarm function is selected to "Alarm on closed contact".
- Check whether it is possible to reset the alarm by switching off the pump safety switch for 1 minute.
- Check the pump display to ensure that the pump is correctly preset. See separate instructions for the pump.

For GOLD CX units with **Grundfos pump**, controlled by means of a contactor.

The contactor is controlled with an On/off signal from Terminals 9-10 on the IQLogic+ module.

The pump is protected by the protective motor switch in the electrical cubicle.

The contactor's On/off signal is interlocked by the protective motor switch.

The in-operation feedback input on Terminals 11-12 on the IQLogic+ module is wired to normally-open auxiliary contacts on the contactor.

- Check that the protective motor switch of the circulation pump is switched On.
- Check that "Contactor function".is selected as the alarm function.
- Check after resetting the alarm that the contactor is energised on a start in the "Manual text" mode.
- If the alarm repeats itself, check that the motor protection is preset for the correct current in relation to the pump.

Fault tracing tripped alarm GOLD E			Document no.	Revision	Page
					58 (146)
			Date released	Supersedes	
Type of document	Drawn up by	Revised by	Released and published by		
Instruktion	Bertil Sjunnesson	Magnus Hallén			

2.14. Alarm group 17: ROTARY HEAT EXCHANGER

2.14.1. Alarm no. 17:1 "Rotary heat exchanger, communication error, motor controller"

The alarm is enabled when a GOLD RX unit is selected.

The alarm trips if the control unit does not achieve correct communication with the heat exchanger's motor controller.

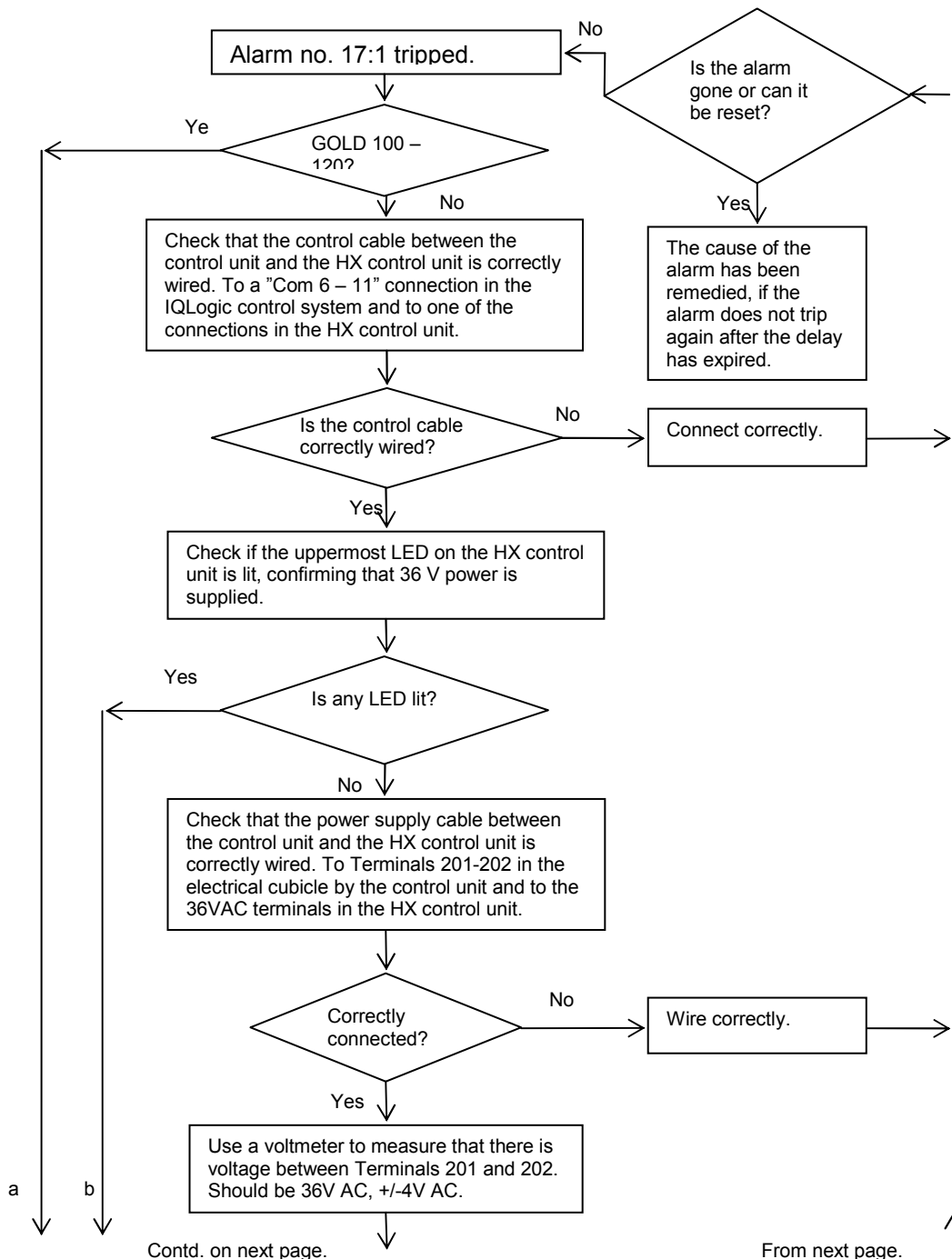

Fault tracing tripped alarm GOLD E			Document no.	Revision	Page
					59 (146)
			Date released	Supersedes	
Type of document	Drawn up by	Revised by	Released and published by		
Instruktion	Bertil Sjunnesson	Magnus Hallén			

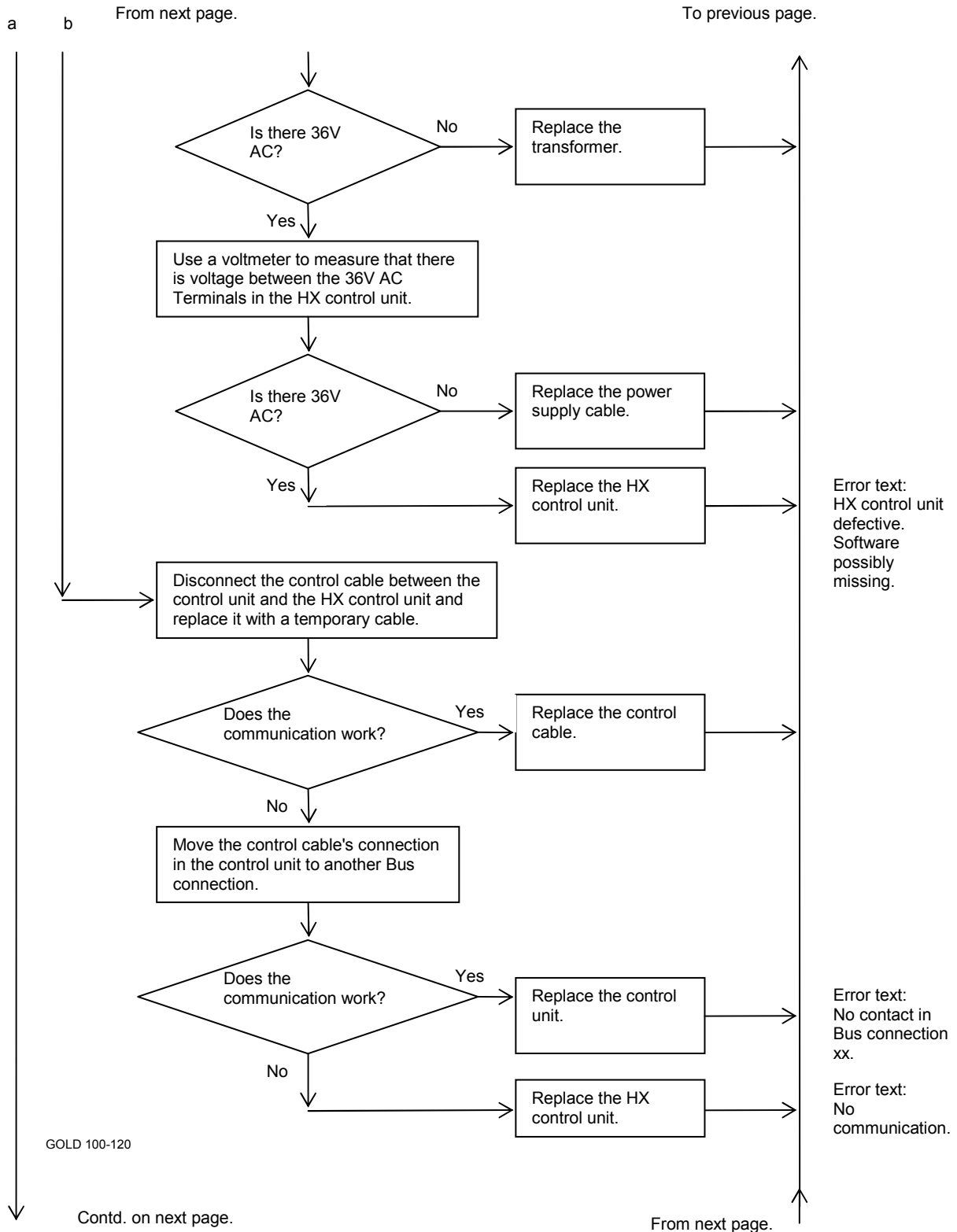

Fault tracing tripped alarm GOLD E			Document no.	Revision	Page
					60 (146)
			Date released	Supersedes	
Type of document	Drawn up by	Revised by	Released and published by		
Instruktion	Bertil Sjunnesson	Magnus Hallén			

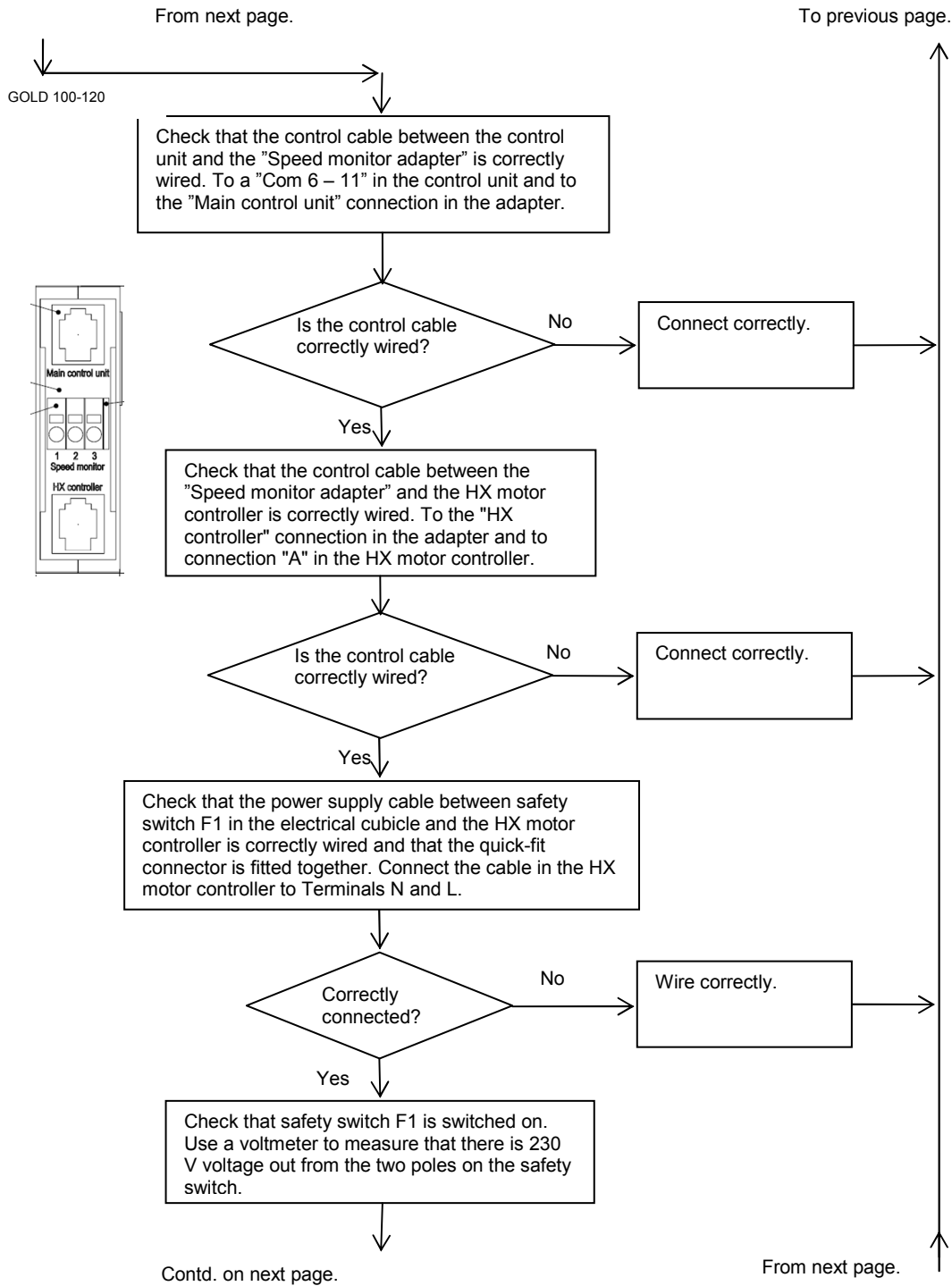

Fault tracing tripped alarm GOLD E			<i>Document no.</i>	<i>Revision</i>	<i>Page</i>
					61 (146)
			<i>Date released</i>	<i>Supersedes</i>	
<i>Type of document</i> Instruktion	<i>Drawn up by</i> Bertil Sjunnesson	<i>Revised by</i> Magnus Hallén	<i>Released and published by</i>		

From next page.

To previous page.

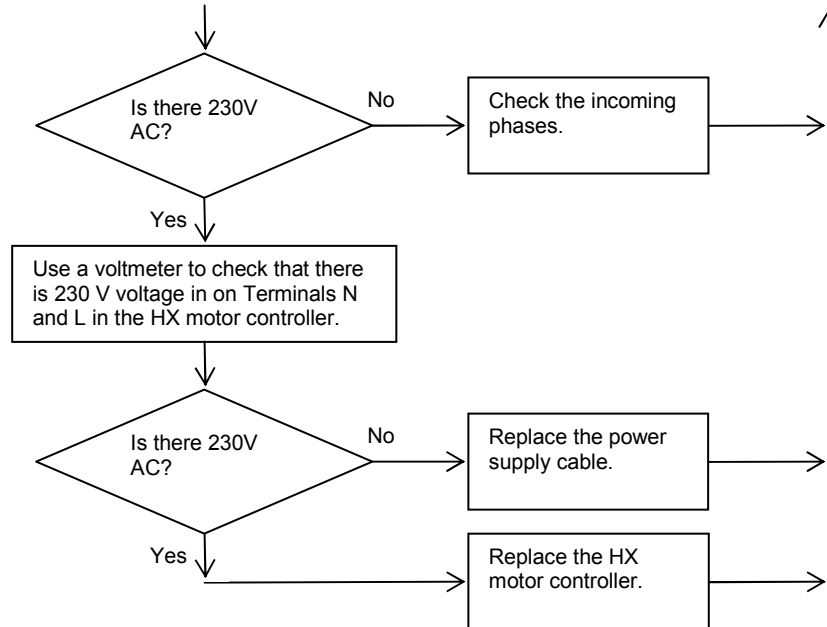

Fault tracing tripped alarm GOLD E			Document no.	Revision	Page
					62 (146)
Date released		Supersedes			
Type of document	Drawn up by	Revised by	Released and published by		
Instruktion	Bertil Sjunnesson	Magnus Hallén			

2.14.2. Alarm 17:2 "Rotary heat exchanger, communication error, pressure sensor 7 defrost"

The alarm is enabled when the Heat exchanger, Defrost function is activated.
The alarm trips when the control unit does not obtain communication with the relevant pressure sensor.

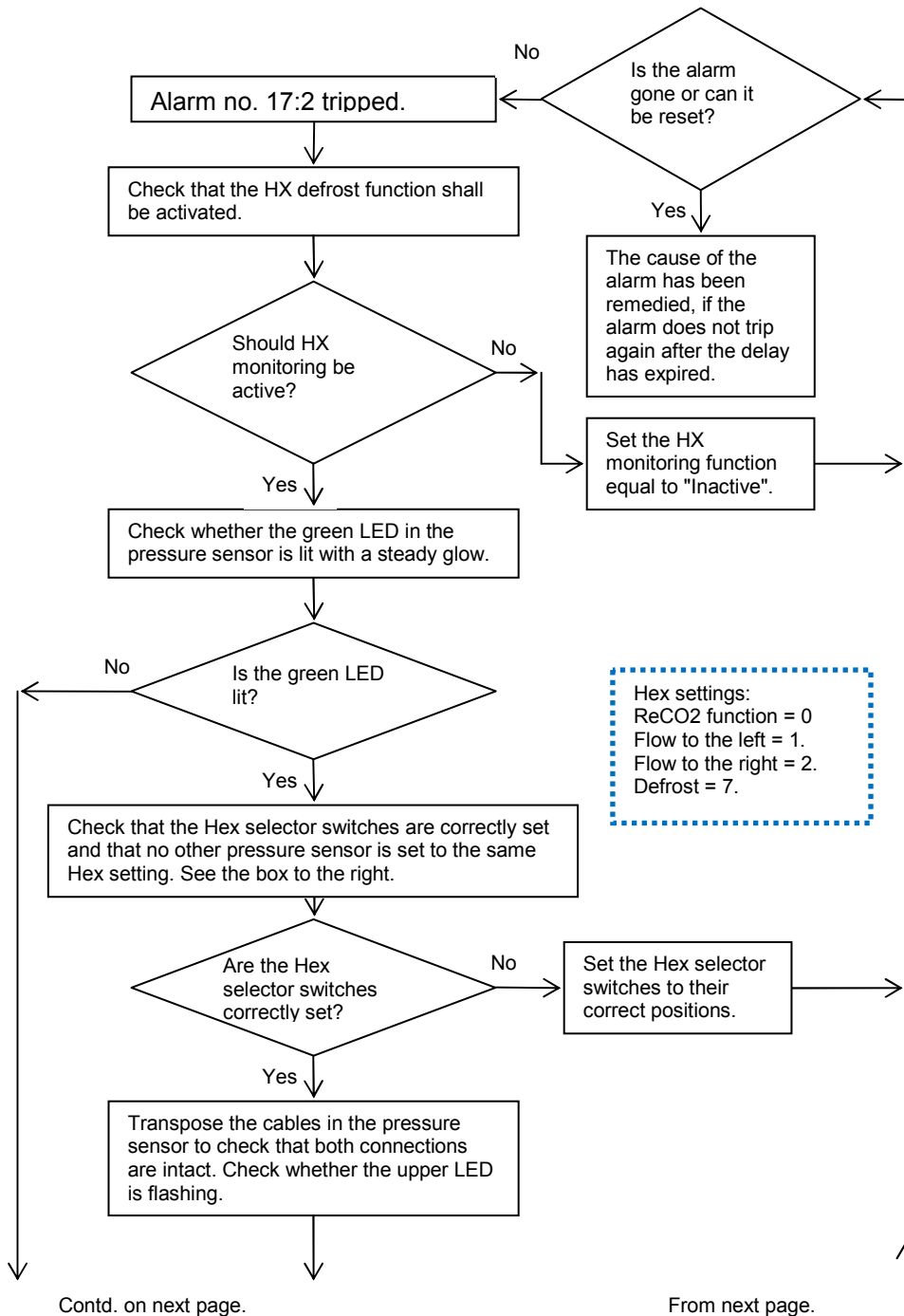

Fault tracing tripped alarm GOLD E			<i>Document no.</i>	<i>Revision</i>	<i>Page</i>
					63 (146)
			<i>Date released</i>	<i>Supersedes</i>	
<i>Type of document</i> Instruktion	<i>Drawn up by</i> Bertil Sjunnesson	<i>Revised by</i> Magnus Hallén	<i>Released and published by</i>		

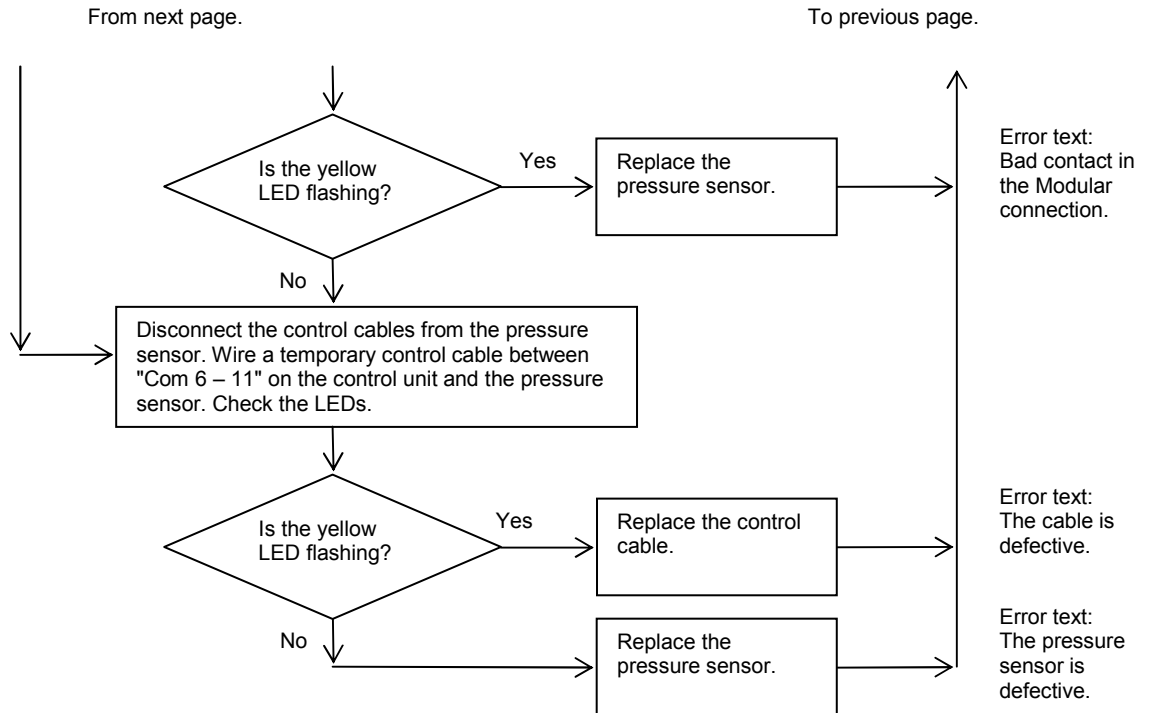

Fault tracing tripped alarm GOLD E			Document no.	Revision	Page
					64 (146)
			Date released	Supersedes	
Type of document	Drawn up by	Revised by	Released and published by		
Instruktion	Bertil Sjunnesson	Magnus Hallén			

2.14.3. Alarm no. 17:3 "Rotary heat exchanger, defrost pressure above alarm limit".

The alarm is enabled if the GOLD RX is selected and the defrost function is activated.

When the pressure across the heat exchanger is above the preset "Defrost limit", a defrost controller begins to operate.

If the controller has continuously worked with a value of >95% during the delay (2.4 hours), the alarm will trip.

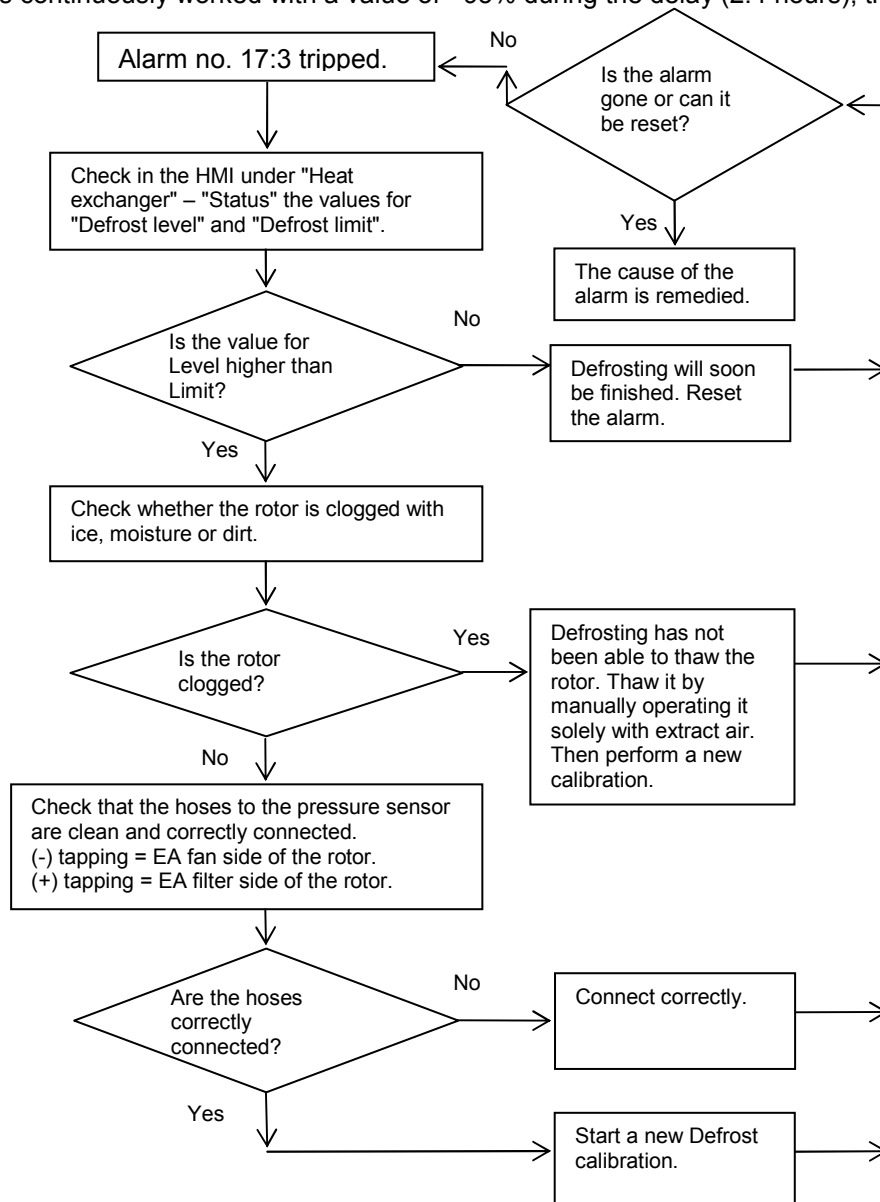

Fault tracing tripped alarm GOLD E			Document no.	Revision	Page
					65 (146)
			Date released	Supersedes	
Type of document	Drawn up by	Revised by	Released and published by		
Instruktion	Bertil Sjunnesson	Magnus Hallén			

2.14.4. Alarm no. 17:4 "Rotary heat exchanger, rotation monitor tripped"

The alarm is enabled if the GOLD RX is selected.

The alarm trips when the HX control unit does not detect pulses from the rotation monitor sensor, within the time that corresponds to about 2 turns of the rotor with the relevant control signal. No more than one pulse per rotor revolution is permissible (exception: G50-80).

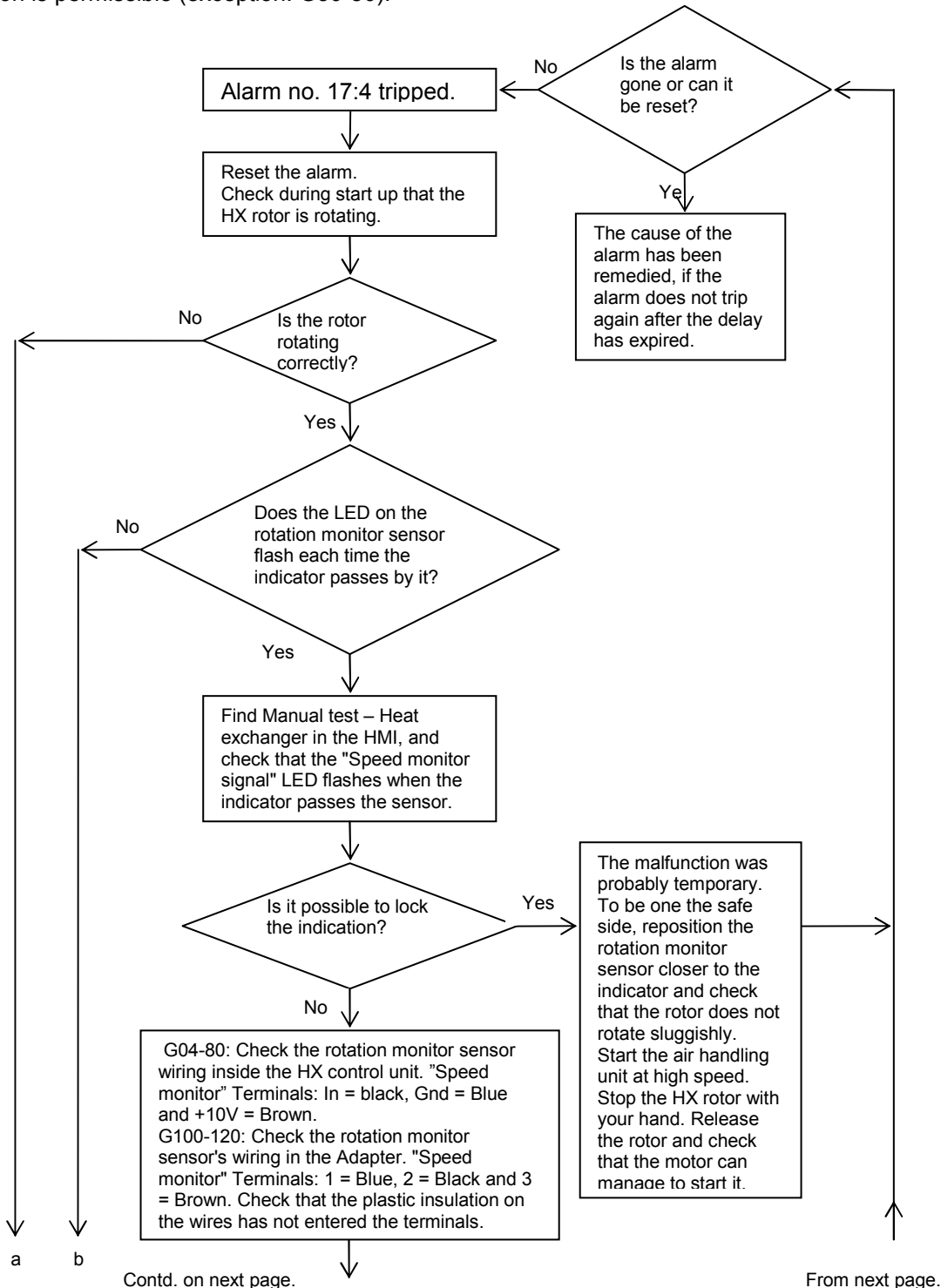

Fault tracing tripped alarm GOLD E			Document no.	Revision	Page
					66 (146)
			Date released	Supersedes	
Type of document Instruktion	Drawn up by Bertil Sjunnesson	Revised by Magnus Hallén	Released and published by		

§§§§

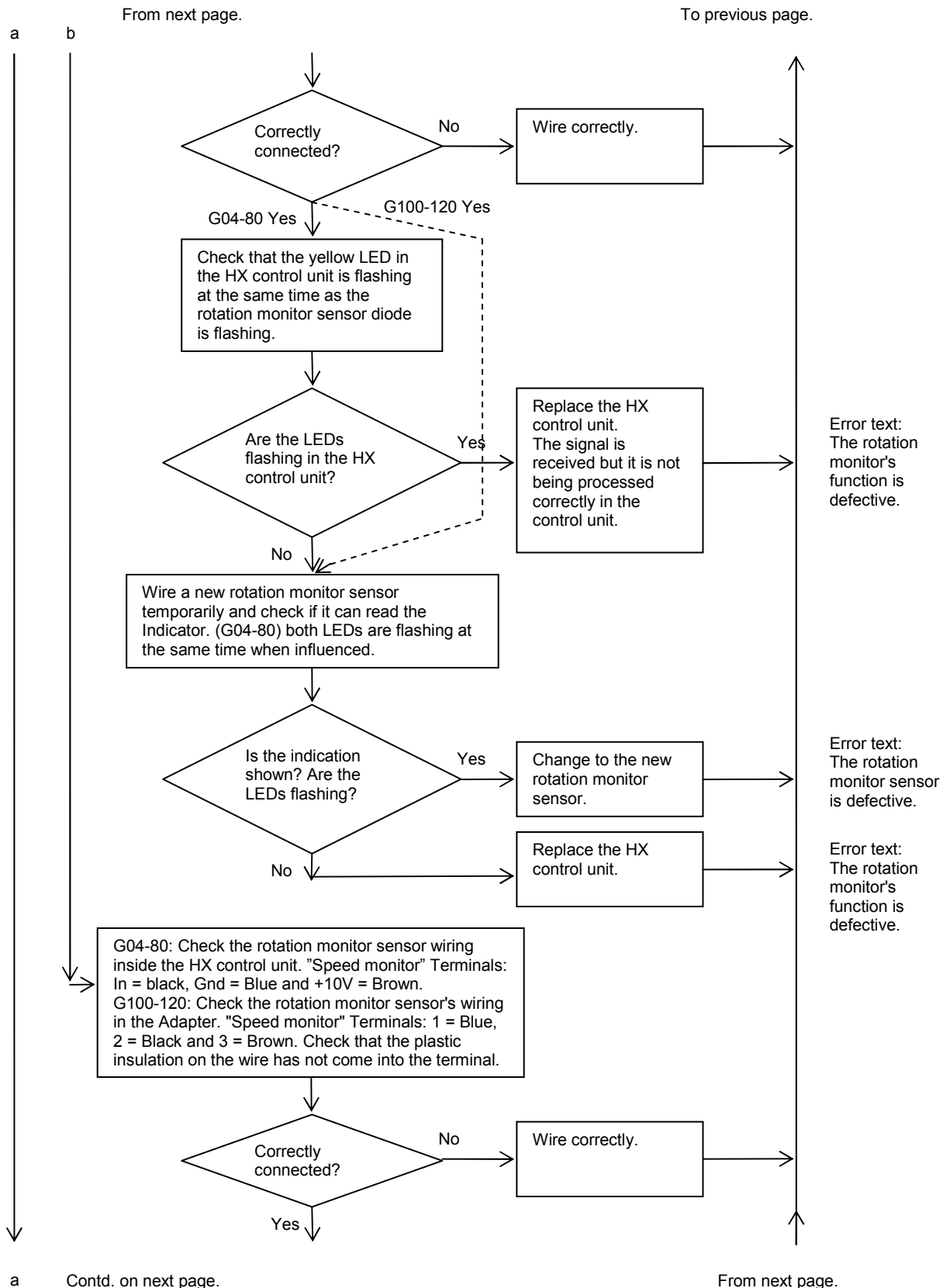

Fault tracing tripped alarm GOLD E			<i>Document no.</i>	<i>Revision</i>	<i>Page</i>
					67 (146)
			<i>Date released</i>	<i>Supersedes</i>	
<i>Type of document</i> Instruktion	<i>Drawn up by</i> Bertil Sjunnesson	<i>Revised by</i> Magnus Hallén	<i>Released and published by</i>		

Fault tracing tripped alarm GOLD E			Document no.	Revision	Page
					68 (146)
			Date released	Supersedes	
Type of document Instruktion	Drawn up by Bertil Sjunnesson	Revised by Magnus Hallén	Released and published by		

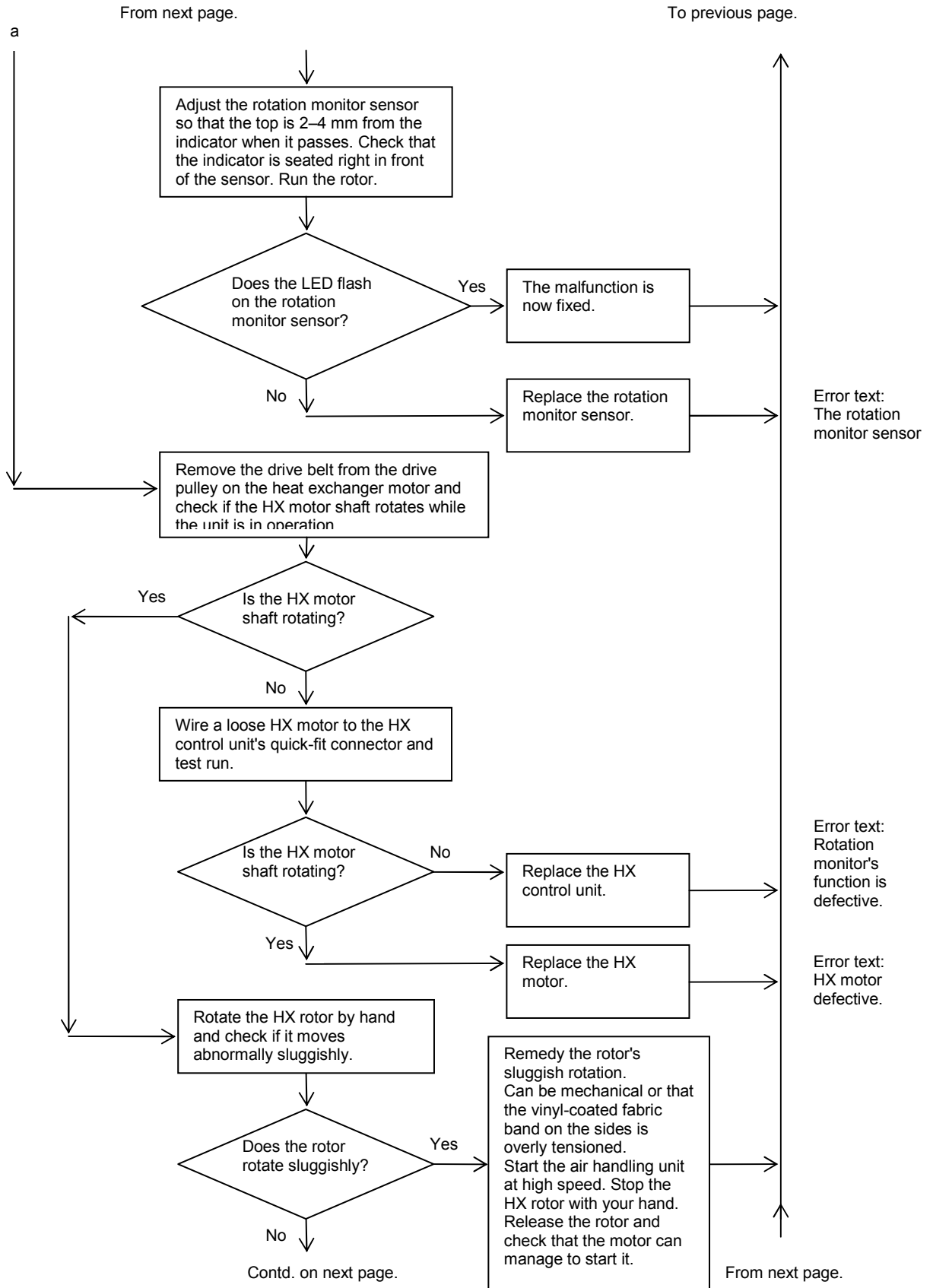

Fault tracing tripped alarm GOLD E			<i>Document no.</i>	<i>Revision</i>	<i>Page</i>
					69 (146)
			<i>Date released</i>	<i>Supersedes</i>	
<i>Type of document</i> Instruktion	<i>Drawn up by</i> Bertil Sjunnesson	<i>Revised by</i> Magnus Hallén	<i>Released and published by</i>		

From next page.

To previous page.

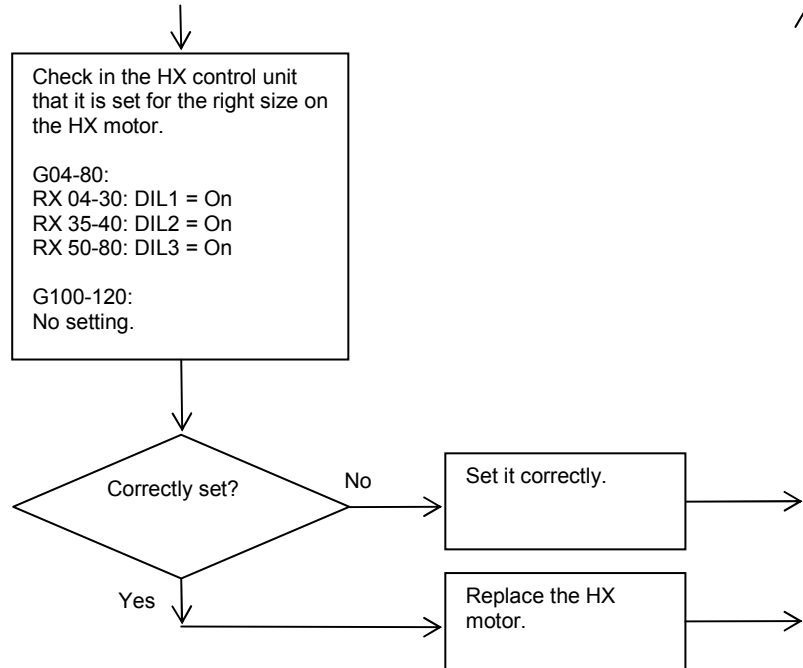

Fault tracing tripped alarm GOLD E			Document no.	Revision	Page
					70 (146)
			Date released	Supersedes	
Type of document	Drawn up by	Revised by	Released and published by		
Instruktion	Bertil Sjunnesson	Magnus Hallén			

2.14.5. Alarm no. 17:5 "Rotary heat exchanger, over current to HX control system".

The alarm is enabled if the GOLD RX is selected.

The alarms trip when the internal monitoring in the HX control unit detects current to the HX motor above the alarm limit.

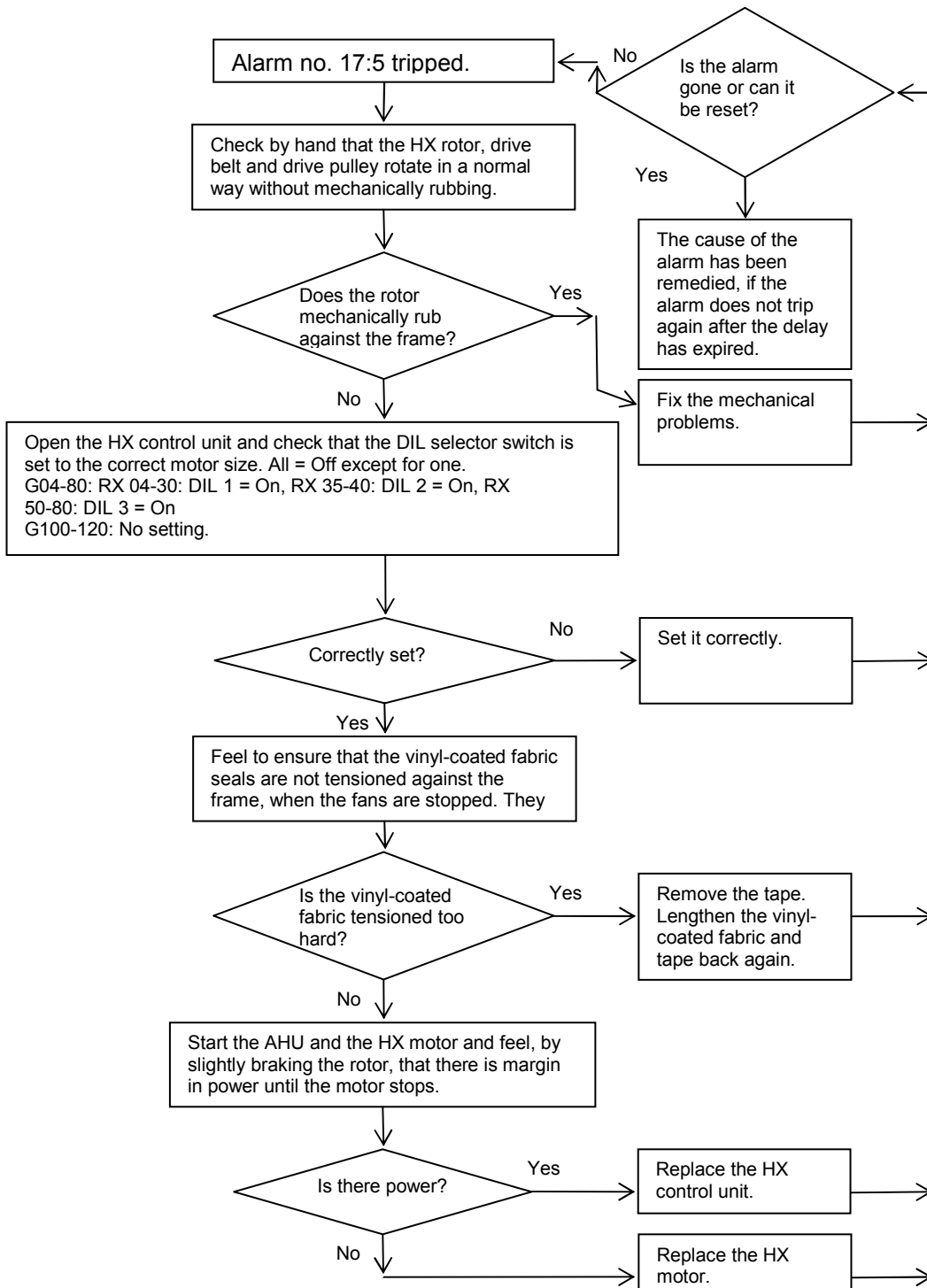

Fault tracing tripped alarm GOLD E			Document no.	Revision	Page
					71 (146)
			Date released	Supersedes	
Type of document	Drawn up by	Revised by	Released and published by		
Instruktion	Bertil Sjunnesson	Magnus Hallén			

2.14.6. Alarm no. 17:6 "Rotary heat exchanger, undercurrent to HX control system".

The alarm is enabled only in GOLD RX units.

The alarms trip when the internal monitoring function in the HX control unit detects voltage below the alarm limit (G04-80 = 25V AC and G100-120 = 160V).

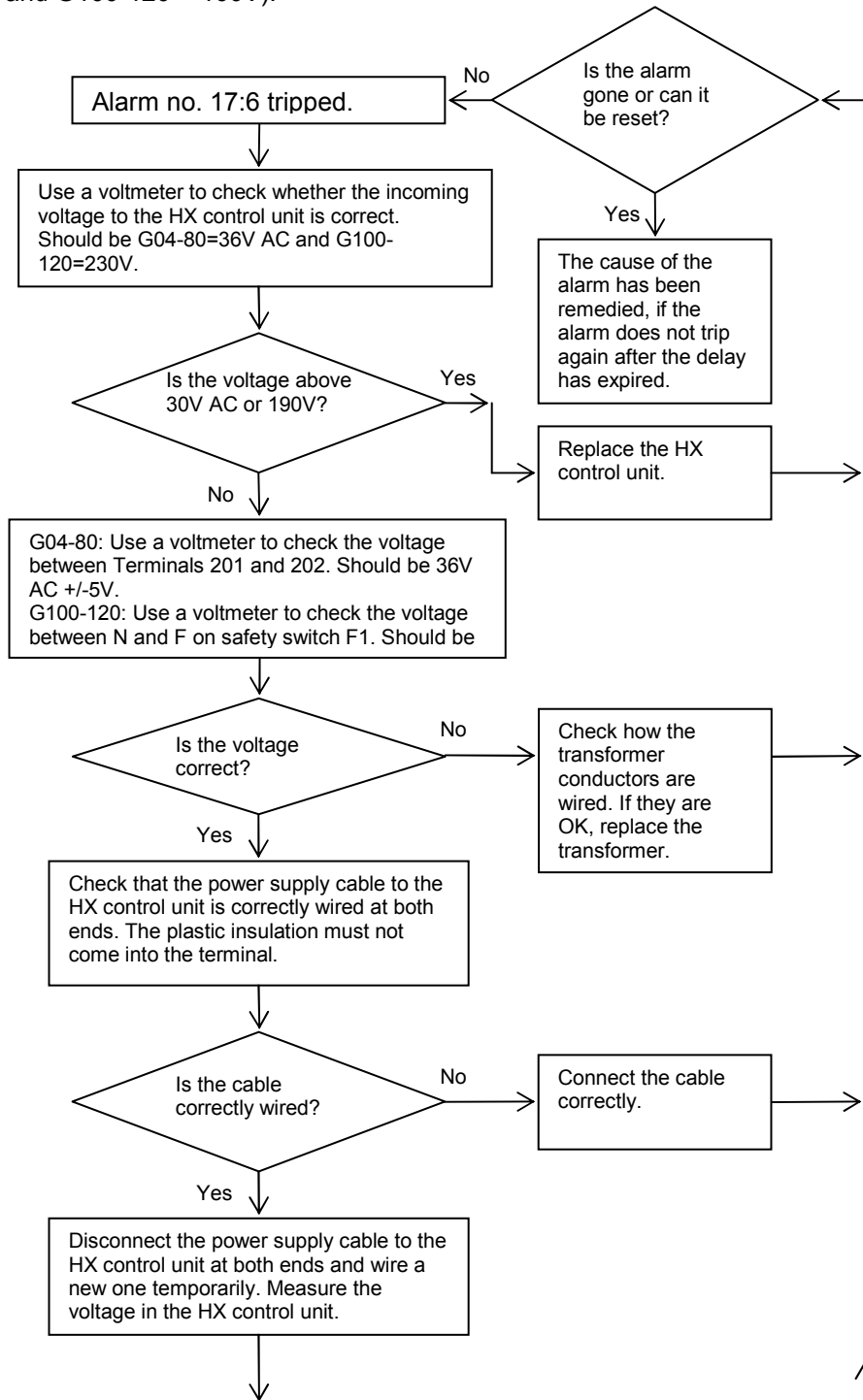

Contd. on next page.

From next page.

Fault tracing tripped alarm GOLD E			Document no.	Revision	Page
					72 (146)
			Date released	Supersedes	
Type of document Instruktion	Drawn up by Bertil Sjunnesson	Revised by Magnus Hallén	Released and published by		

From next page.

To previous page.

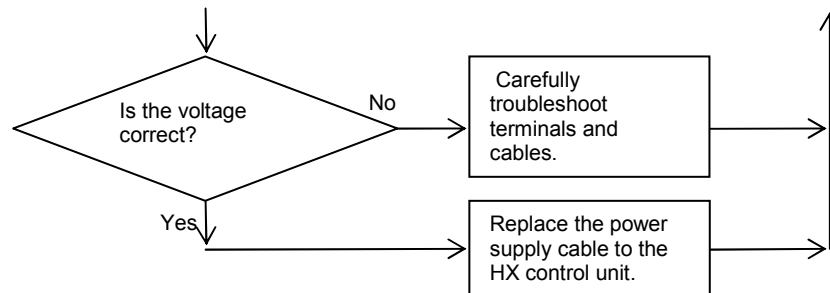

2.14.7. Alarm no. 17:7 "Rotary heat exchanger, over voltage to HX control system".

The alarm is enabled only in GOLD RX units.

The alarms trip when the internal monitoring function in the HX control unit detects voltage above the alarm limit. G04-80 = 55V AC and G100-120 = 340V.

2.14.8. Alarm no. 17:8 "Rotary heat exchanger, over temperature to HX control system".

The alarm is enabled only in GOLD RX units.

The alarms trip when the internal monitoring function in the HX control unit detects that the temperature in the HX control system is above 90°C.

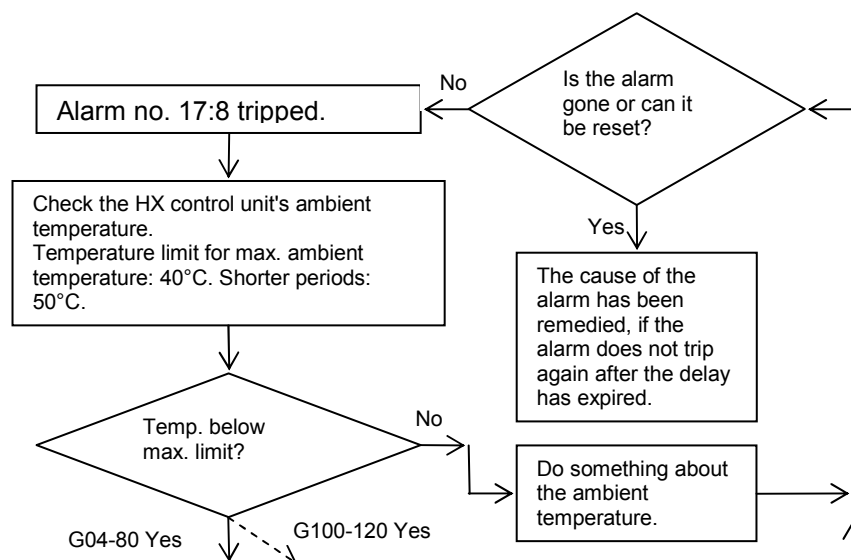

Contd. on next page.

From next page.

Fault tracing tripped alarm GOLD E			Document no.	Revision	Page
					73 (146)
			Date released	Supersedes	
Type of document	Drawn up by	Revised by	Released and published by		
Instruktion	Bertil Sjunnesson	Magnus Hallén			

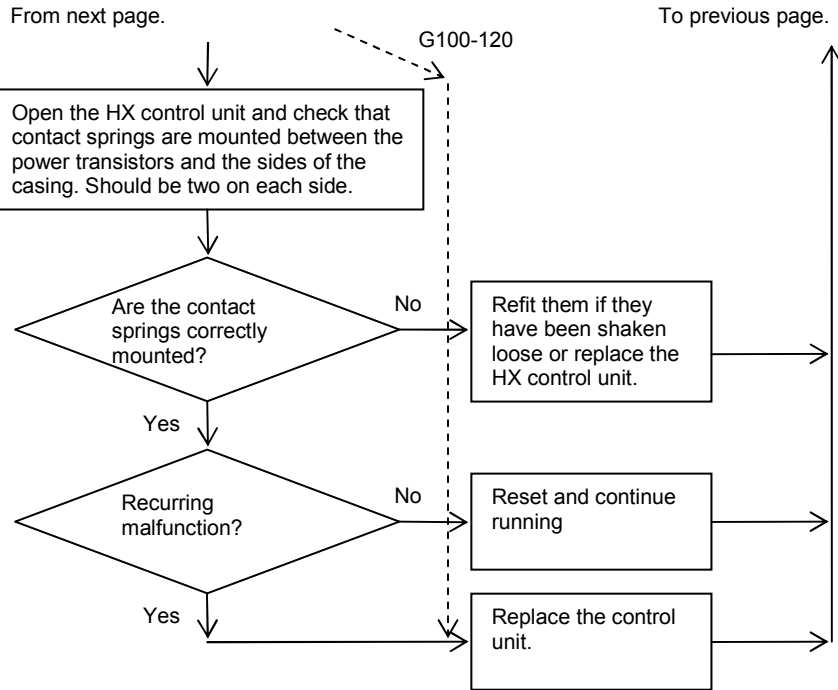

Fault tracing tripped alarm GOLD E			Document no.	Revision	Page
					74 (146)
			Date released	Supersedes	
Type of document	Drawn up by	Revised by	Released and published by		
Instruktion	Bertil Sjunnesson	Magnus Hallén			

2.14.9. Alarm no. 17:9 "Rotary heat exchanger, HX control system start error"

The alarm is enabled only in GOLD RX 100-120 units.
The alarms trip when the internal monitoring function in the HX control unit detects that the HX motor does not start in the correct way.

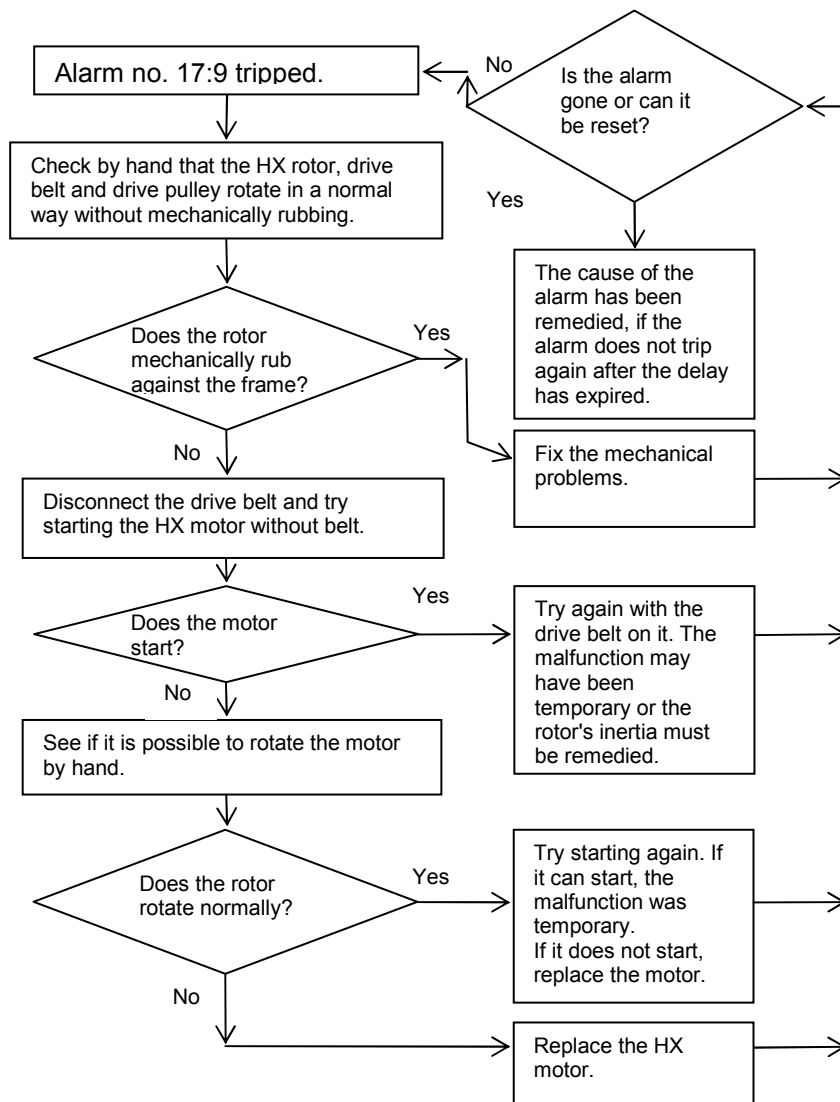

Fault tracing tripped alarm GOLD E			<i>Document no.</i>	<i>Revision</i>	<i>Page</i> 75 (146)
			<i>Date released</i>		<i>Supersedes</i>
<i>Type of document</i> Instruktion	<i>Drawn up by</i> Bertil Sjunnesson	<i>Revised by</i> Magnus Hallén	<i>Released and published by</i>		

2.15. Alarm group 18: AYC

2.15.1. Alarm no. 18:1 "AYC, I/O module no. 7 communication error"

The alarm is enabled when the "All Year Comfort" function is activated.

The alarm trips if the control unit does not achieve correct communication with the module.

For troubleshooting see Alarm no. 3:1 above.

Fault tracing tripped alarm GOLD E			Document no.	Revision	Page
					76 (146)
			Date released	Supersedes	
Type of document	Drawn up by	Revised by	Released and published by		
Instruktion	Bertil Sjunnesson	Magnus Hallén			

2.15.2. Alarm no. 18:2 "AYC Heat, temperature sensor defective"

The alarm is enabled when the "All Year Comfort" function is activated for "Heated water" or Chilled and heated water".

The alarms trip when the control unit does not have communication with the temperature sensor for the heated water circuit or when the sensor measures temperatures outside the range of measurement (-55°C – 125°C).

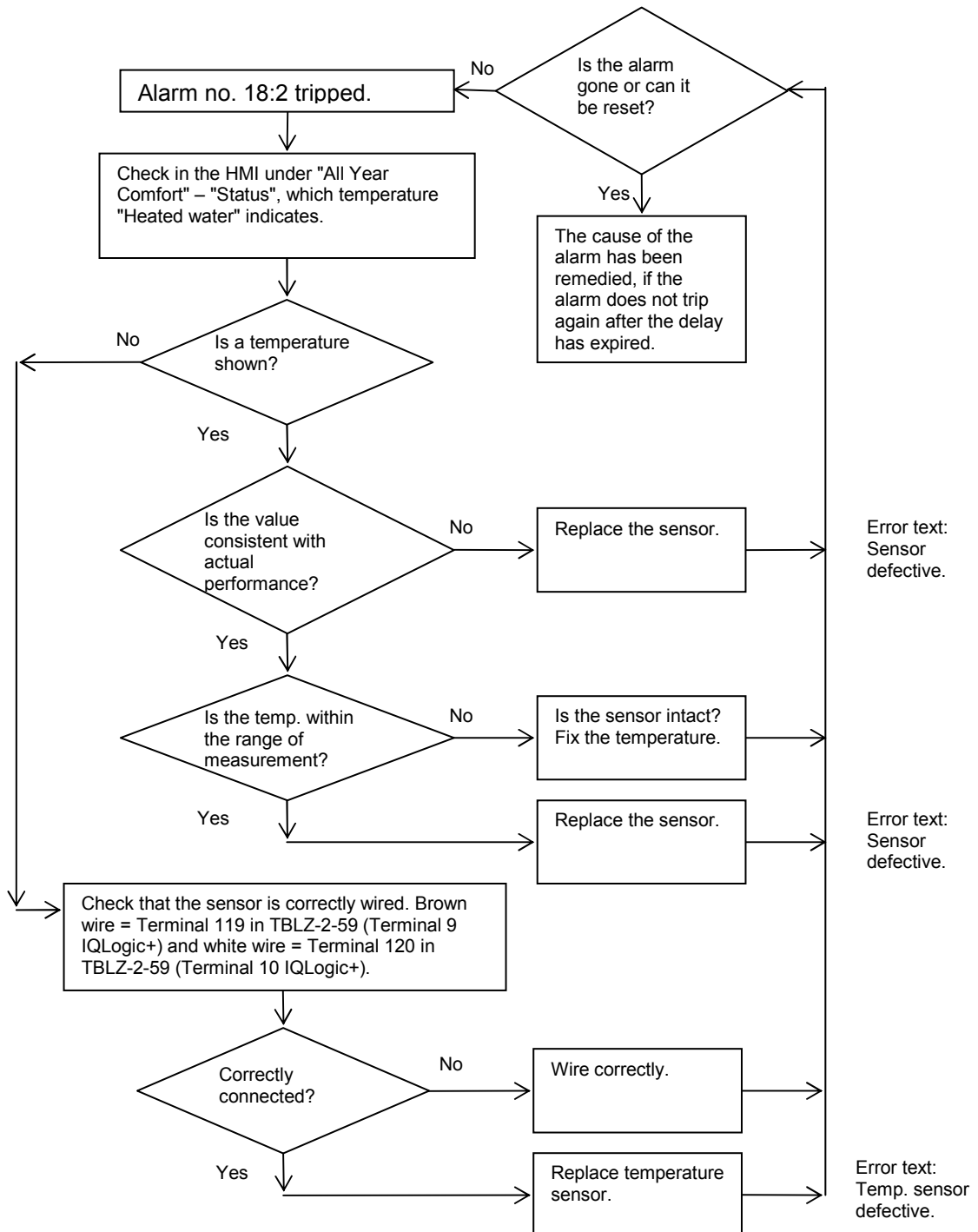

Fault tracing tripped alarm GOLD E			Document no.	Revision	Page
					77 (146)
			Date released	Supersedes	
Type of document	Drawn up by	Revised by	Released and published by		
Instruktion	Bertil Sjunnesson	Magnus Hallén			

2.15.3. Alarm no. 18:3 "AYC Heat, pump monitoring tripped"

The alarm is enabled when the "All Year Comfort" function is activated for "Heated water" or Chilled and heated water".

The alarm trips when the feedback signal (valve input) from the valve actuator does not agree with the control signal (valve output). For a 0-2% output signal the feedback must be < 8% and for a 97-100% output signal >92% so that the alarm will not trip.

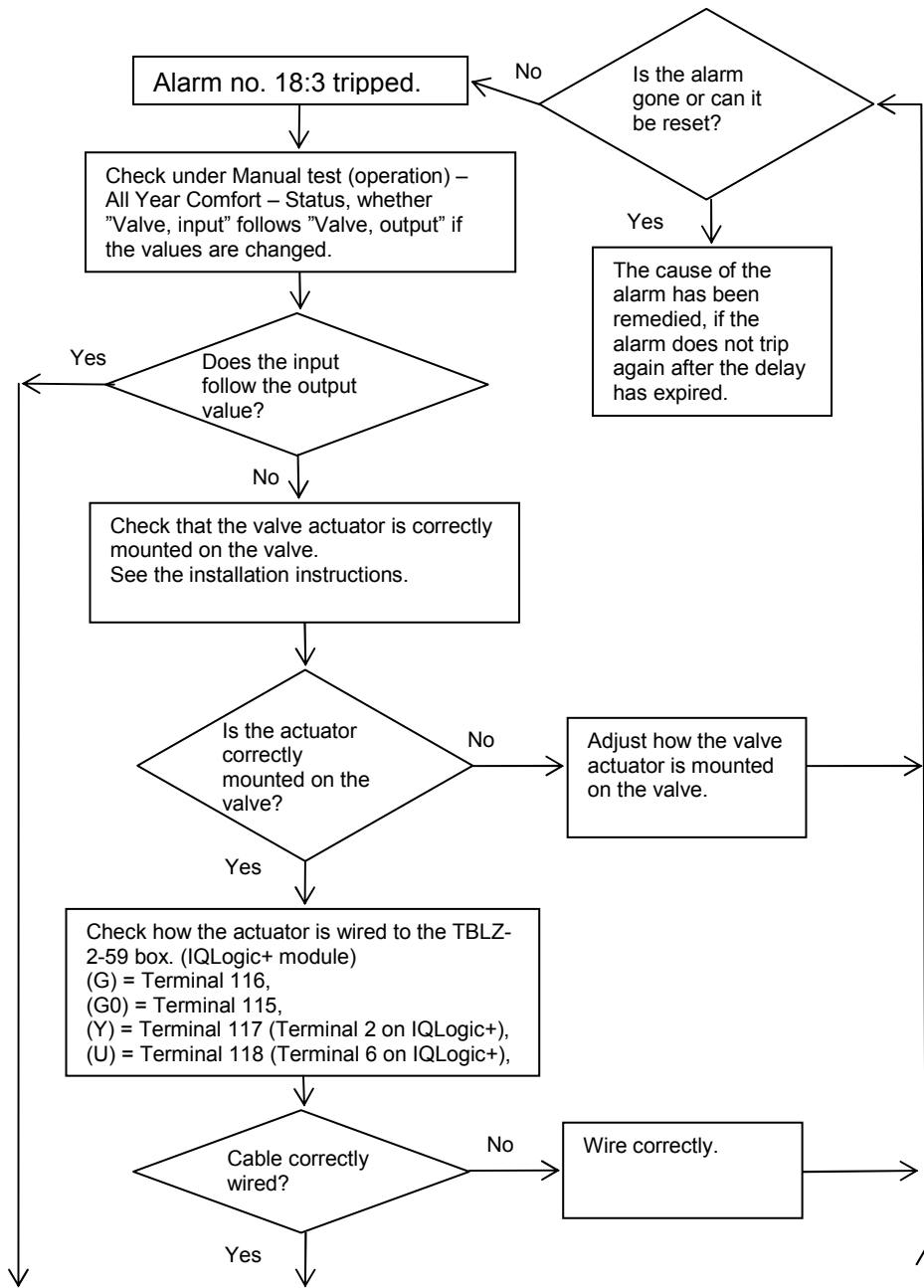

Contd. on next page.

From next page.

Fault tracing tripped alarm GOLD E			Document no.	Revision	Page
					78 (146)
			Date released	Supersedes	
Type of document Instruktion	Drawn up by Bertil Sjunnesson	Revised by Magnus Hallén	Released and published by		

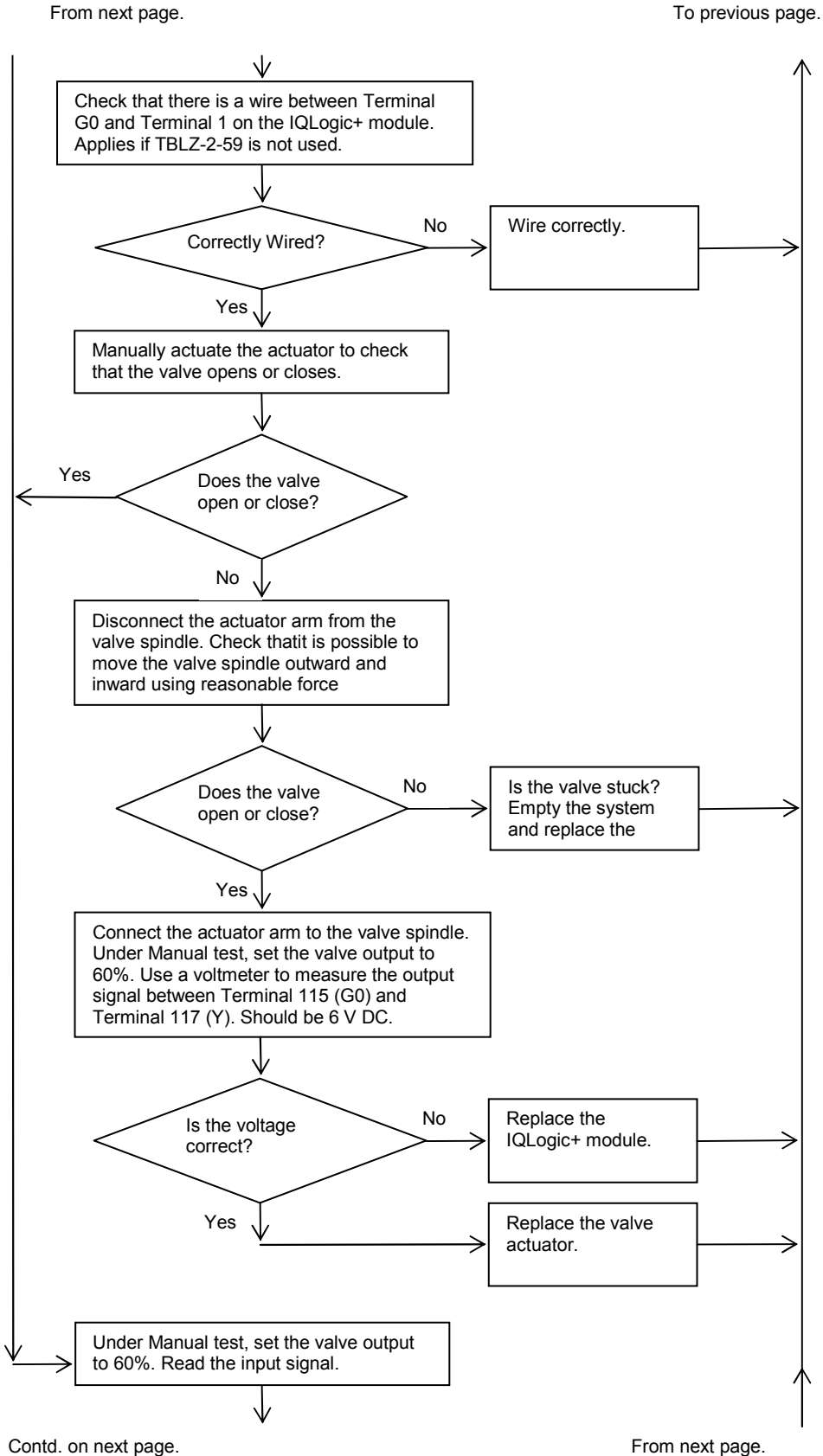

Fault tracing tripped alarm GOLD E			<i>Document no.</i>	<i>Revision</i>	<i>Page</i>
					79 (146)
			<i>Date released</i>	<i>Supersedes</i>	
<i>Type of document</i> Instruktion	<i>Drawn up by</i> Bertil Sjunnesson	<i>Revised by</i> Magnus Hallén	<i>Released and published by</i>		

From next page.

To previous page.

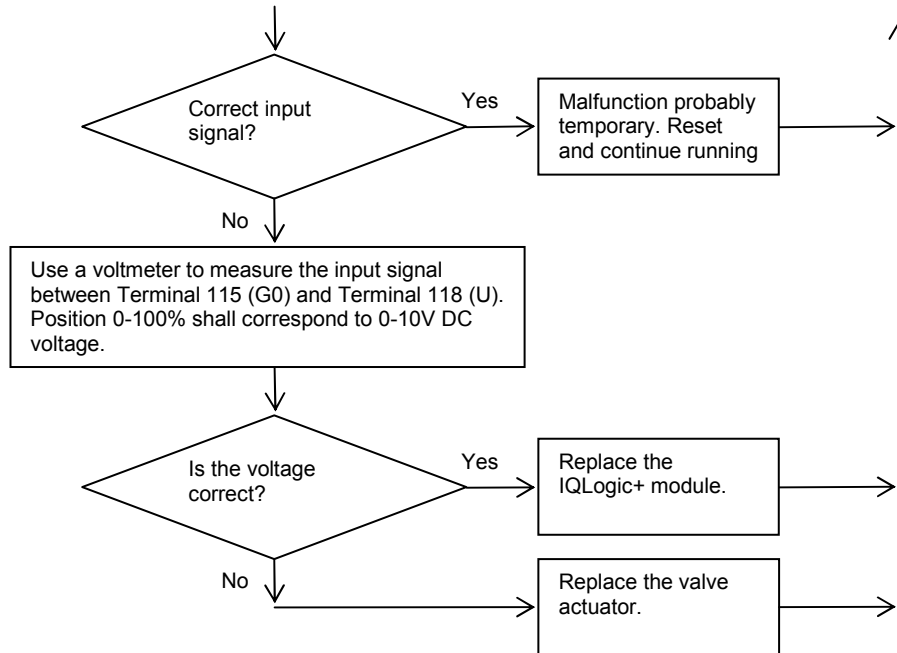

2.15.4. Alarm no. 18:4 "AYC heat, pump monitoring tripped"

The alarm is enabled when the "All Year Comfort" function is activated for "Heated water" or Chilled and heated water" and when any of the "Heated water, pump alarm" functions are selected.

The alarm trips when the current status of the alarm input (closed or open), on Terminals 113-114 in the TBLZ-2-59 box (Terminals 19-20 on IQLogic+ module 7) correspond to the selected alarm function.

Optional functions: "Alarm on open contact", "Alarm on closed contact" and "Contactor function".

Contactor function means that the alarm input must close within 3 seconds after the Pump output has been energised. Used when a contactor is used for controlling the pump.

- Check under "All Year Comfort" – "Status" the status on the "Heated water, pump output" and "Heated water, pump input".

Fault tracing tripped alarm GOLD E			Document no.	Revision	Page
					80 (146)
			Date released	Supersedes	
Type of document	Drawn up by	Revised by	Released and published by		
Instruktion	Bertil Sjunnesson	Magnus Hallén			

2.15.5. Alarm no. 18:5 "AYC Heat, below set point alarm limit"

The alarm is enabled when the "All Year Comfort" function is activated for "Heated water" or Chilled and heated water".

The alarms trip when the water temperature for AYC Heat is below the relevant alarm limit in relation to the set point for more than 20 minutes. Check that the preset alarm limit is appropriate.

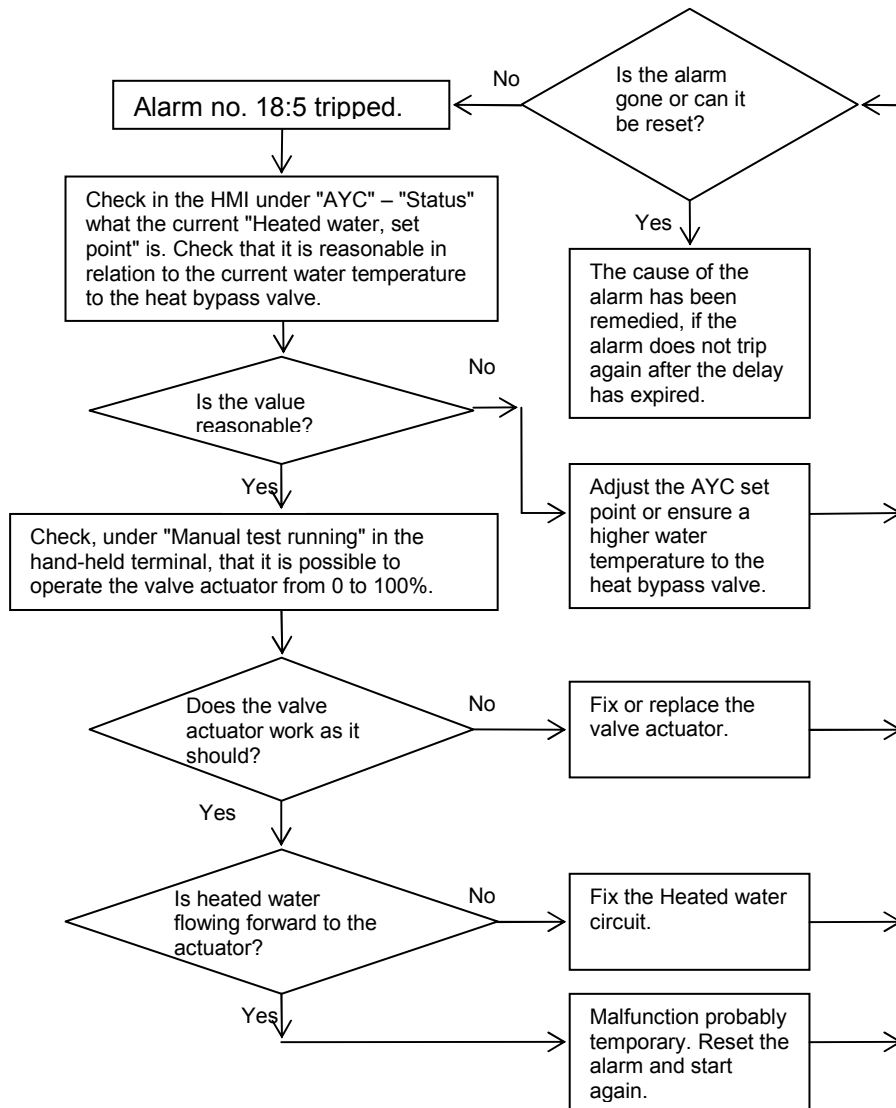

Fault tracing tripped alarm GOLD E			Document no.	Revision	Page
					81 (146)
			Date released	Supersedes	
Type of document	Drawn up by	Revised by	Released and published by		
Instruktion	Bertil Sjunnesson	Magnus Hallén			

2.15.6. Alarm no. 18:6 "AYC Heat, above set point alarm limit"

The alarm is enabled when the "All Year Comfort" function is activated for "Heated water" or Chilled and heated water" and the alarm is manually activated under Alarm priority.

The alarms trip when the water temperature for AYC Heat is above the relevant alarm limit in relation to the set point for more than 20 minutes. Check that the preset alarm limit is appropriate.

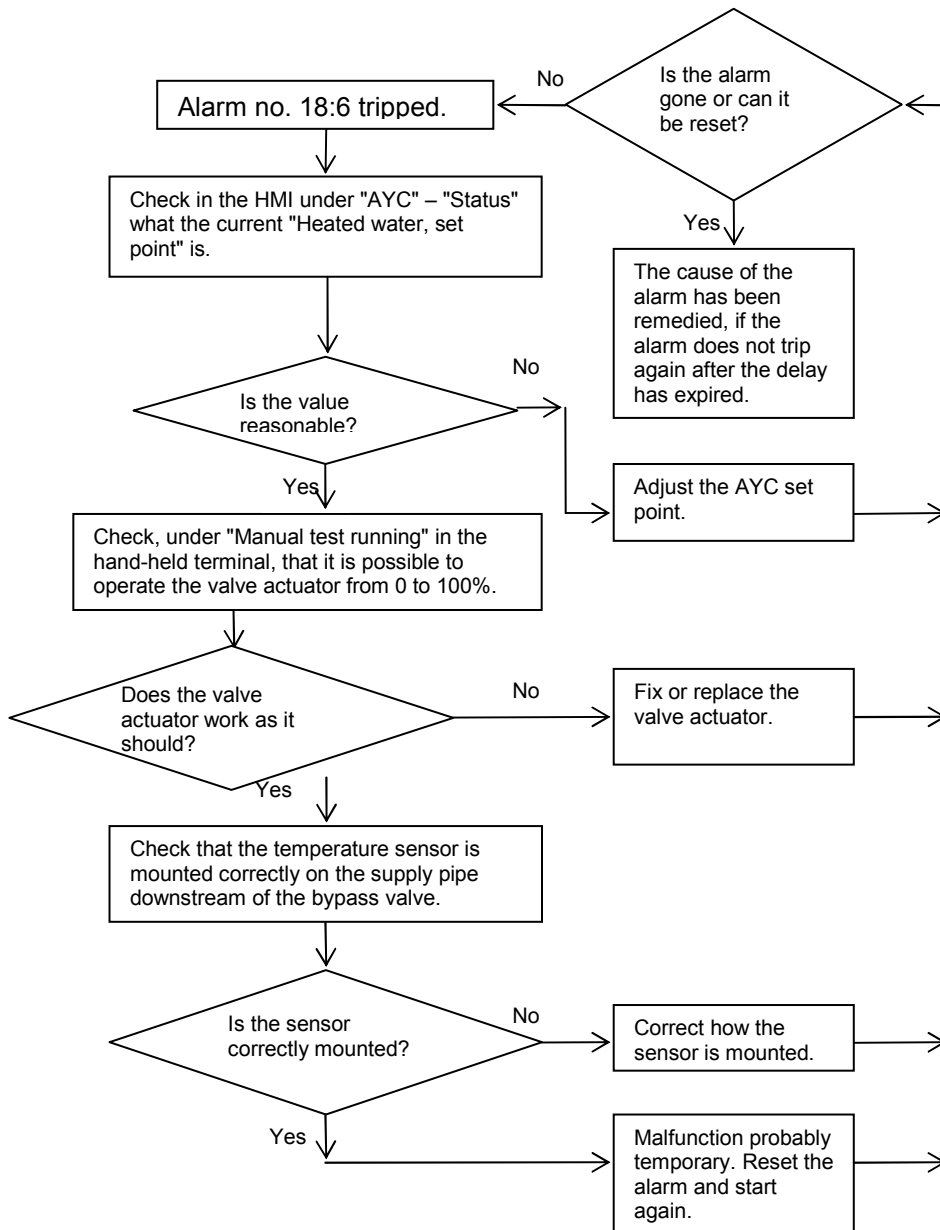

Fault tracing tripped alarm GOLD E			Document no.	Revision	Page
					82 (146)
			Date released	Supersedes	
Type of document	Drawn up by	Revised by	Released and published by		
Instruktion	Bertil Sjunnesson	Magnus Hallén			

2.15.7. Alarm no. 18:9 "AYC Cool, temperature sensor defective"

The alarm is enabled when the "All Year Comfort" function is activated for "chilled water" or Chilled and heated water".

The alarms trip when the control unit does not have communication with the temperature sensor for the heated water circuit or when the sensor measures temperatures outside the range of measurement (-55°C – 125°C).

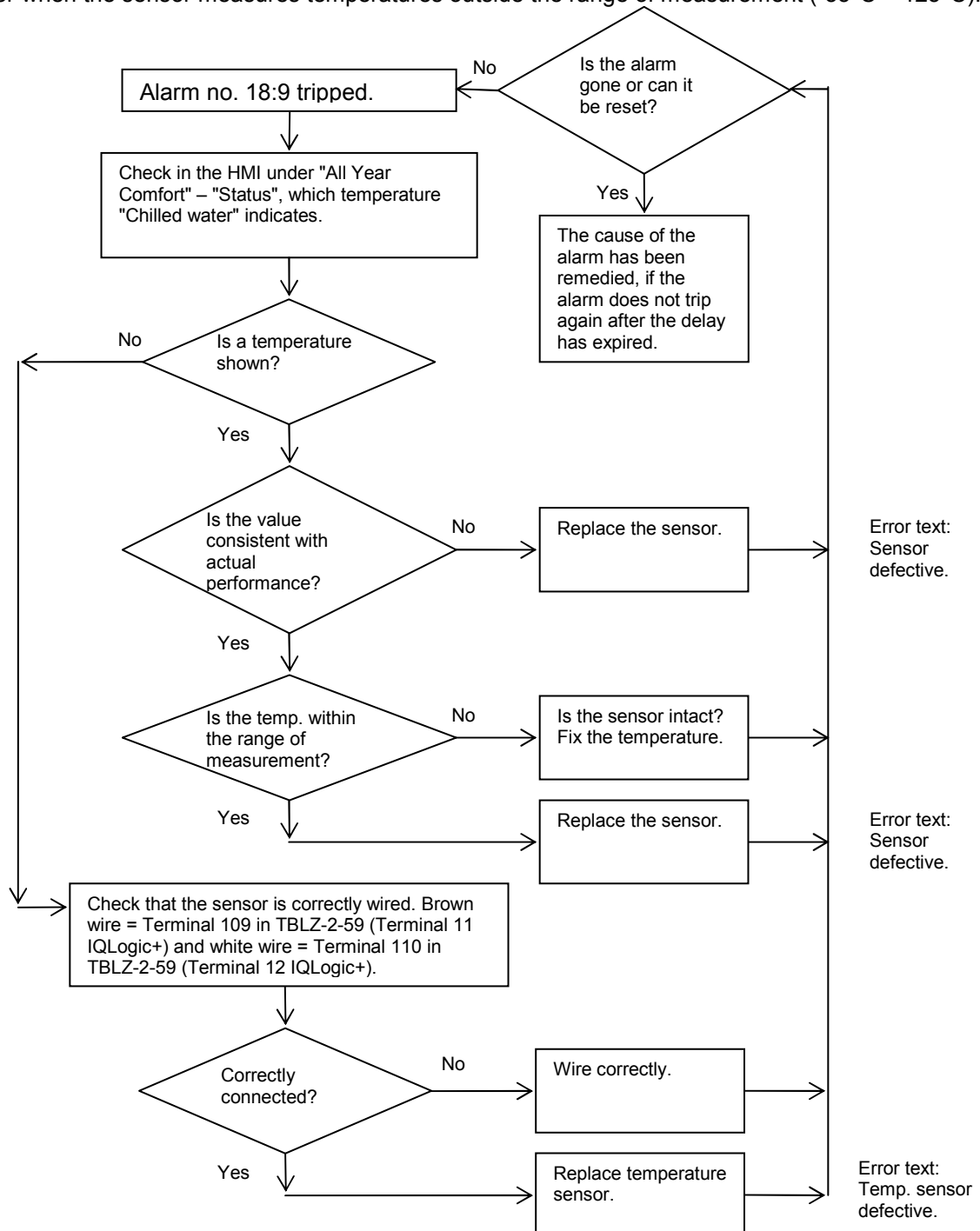

Fault tracing tripped alarm GOLD E			Document no.	Revision	Page
					83 (146)
			Date released	Supersedes	
Type of document	Drawn up by	Revised by	Released and published by		
Instruktion	Bertil Sjunnesson	Magnus Hallén			

2.15.8. Alarm no. 18:10 "AYC Cool, valve monitoring tripped"

The alarm is enabled when the "All Year Comfort" function is activated for "Heated water" or Chilled and heated water".

The alarm trips when the feedback signal (valve input) from the valve actuator does not agree with the control signal (valve output).

For a 0-2% output signal the feedback must be < 8% and for a 97-100% output signal >92% so that the alarm will not trip.

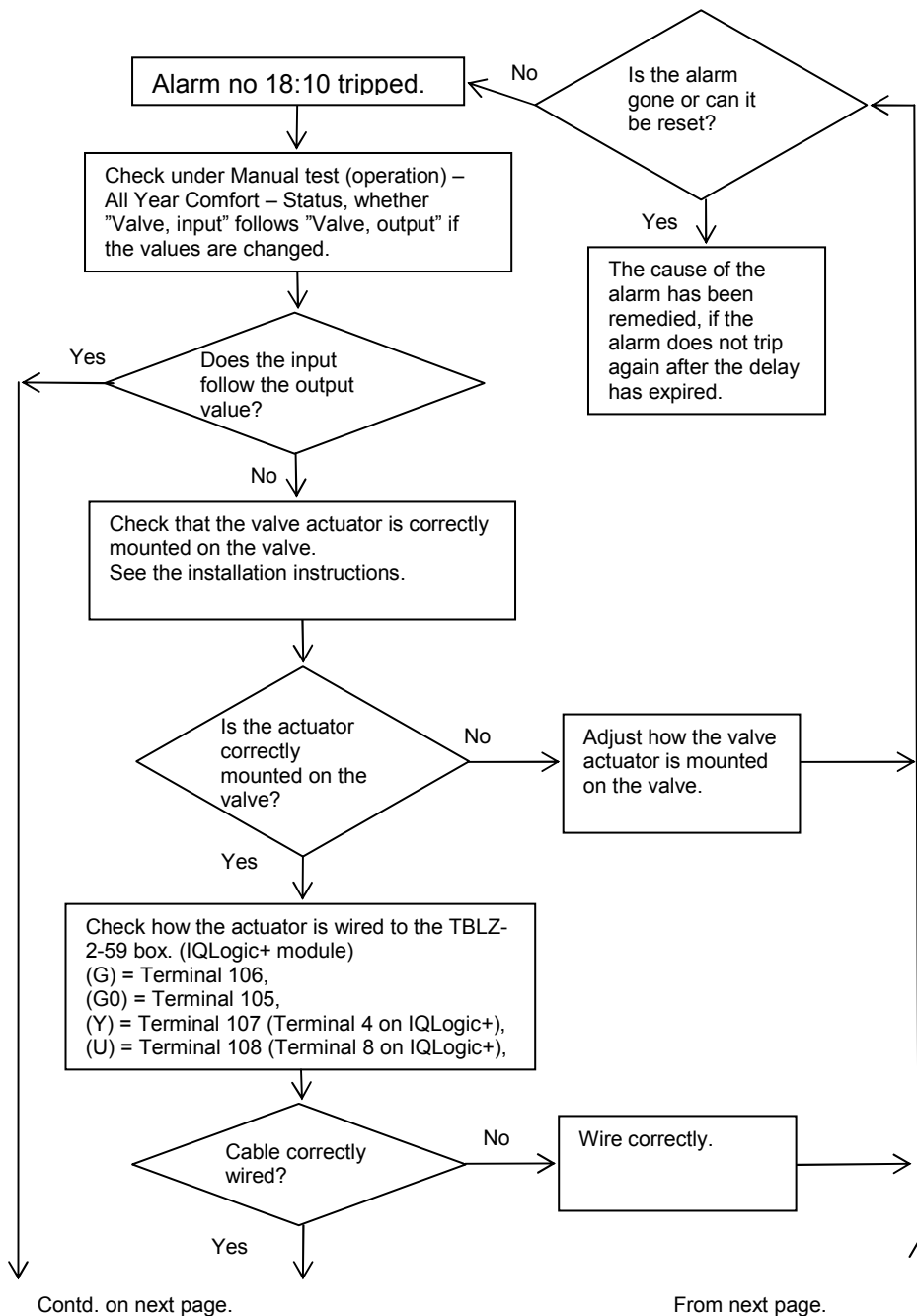

Fault tracing tripped alarm GOLD E			Document no.	Revision	Page
					84 (146)
			Date released	Supersedes	
Type of document Instruktion	Drawn up by Bertil Sjunnesson	Revised by Magnus Hallén	Released and published by		

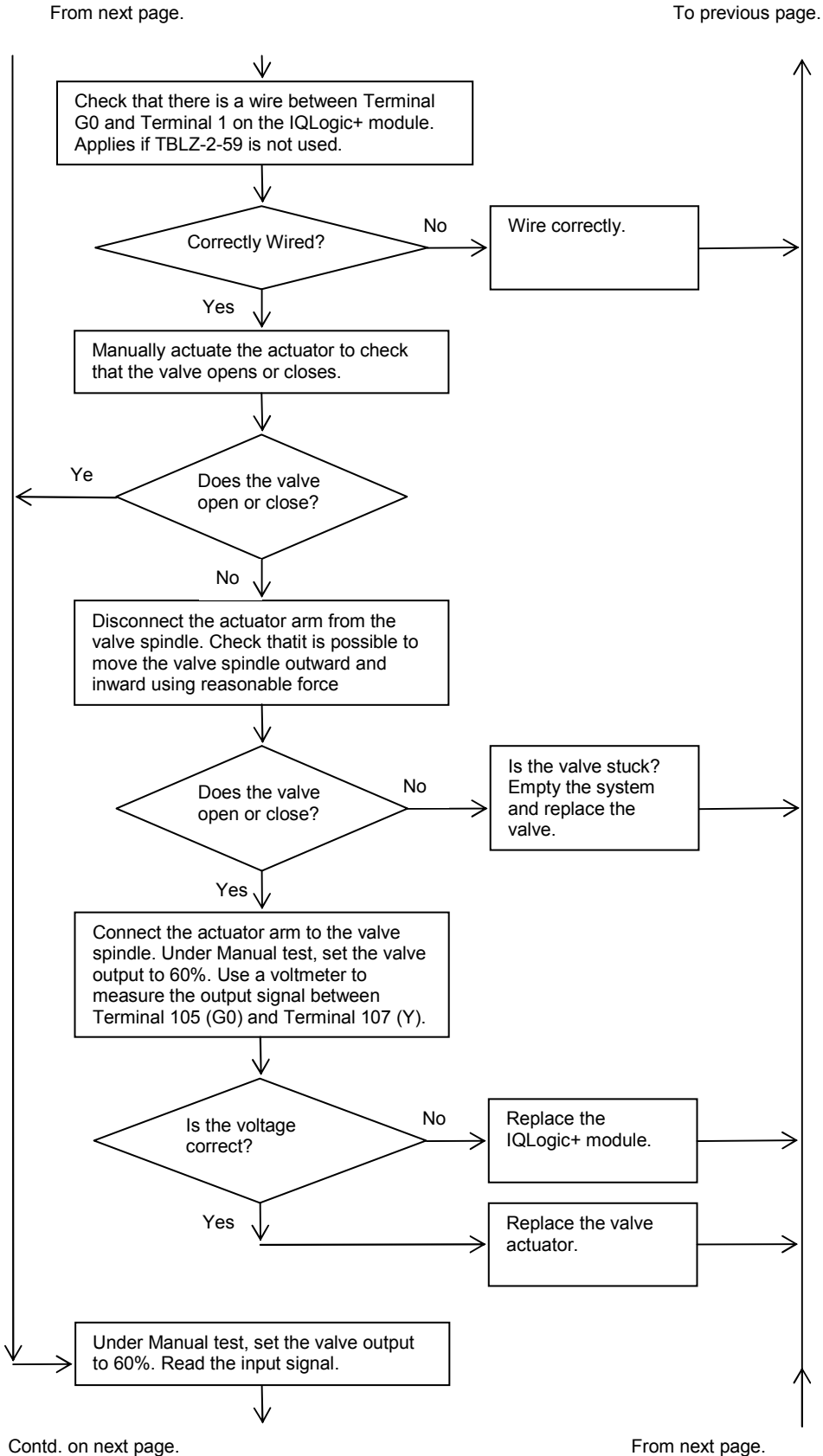

Fault tracing tripped alarm GOLD E			<i>Document no.</i>	<i>Revision</i>	<i>Page</i>
					85 (146)
			<i>Date released</i>	<i>Supersedes</i>	
<i>Type of document</i> Instruktion	<i>Drawn up by</i> Bertil Sjunnesson	<i>Revised by</i> Magnus Hallén	<i>Released and published by</i>		

From next page.

To previous page.

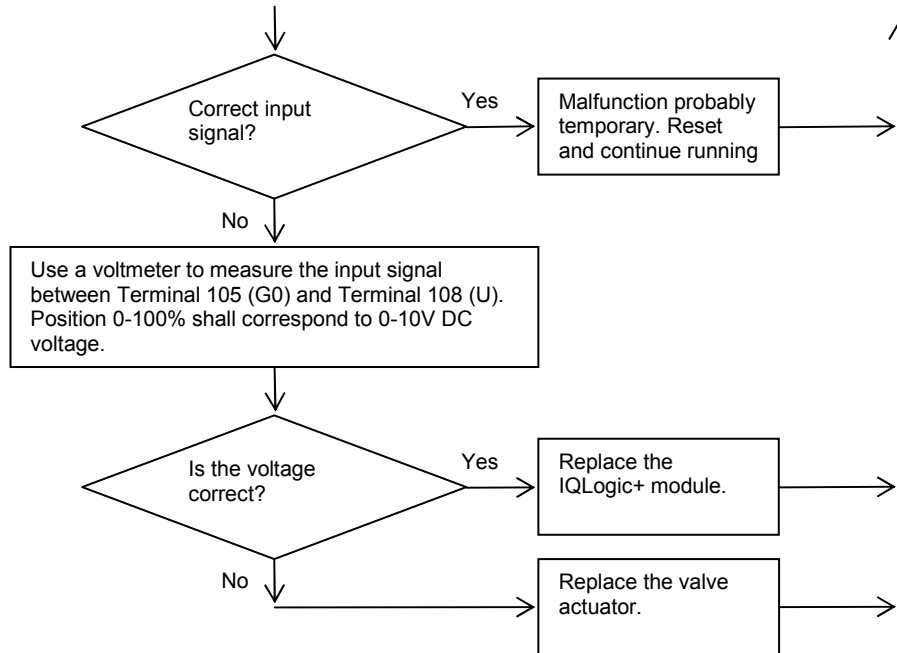

2.15.9. Alarm no. 18:11 "AYC Cool, pump monitoring tripped"

The alarm is enabled when the "All Year Comfort" function is activated for "Chilled water" or Chilled and heated water" and when any of the "Chilled water, pump alarm" functions are selected.

The alarm trips when the current status of the alarm input (closed or open), on Terminals 103-104 in the TBLZ-2-59 box (Terminals 17-18 on IQLogic+ module 7) correspond to the selected alarm function.

Optional functions: "Alarm on open contact", "Alarm on closed contact" and "Contactor function".

Contactor function means that the alarm input must close within 3 seconds after the Pump output has been energised. Used when a contactor is used for controlling the pump.

- Check under "All Year Comfort" – "Status" the status on the "Chilled water, pump output" and "Chilled water, pump input".

Fault tracing tripped alarm GOLD E			Document no.	Revision	Page
					86 (146)
			Date released	Supersedes	
Type of document	Drawn up by	Revised by	Released and published by		
Instruktion	Bertil Sjunnesson	Magnus Hallén			

2.15.10. Alarm 18:12 "AYC Cool, below set point alarm limit"

The alarm is enabled when the "All Year Comfort" function is activated for "chilled water" or Chilled and heated water".

The alarms trip when the water temperature for AYC Cool is below the relevant alarm limit in relation to the set point for more than 20 minutes. Check that the preset alarm limit is appropriate.

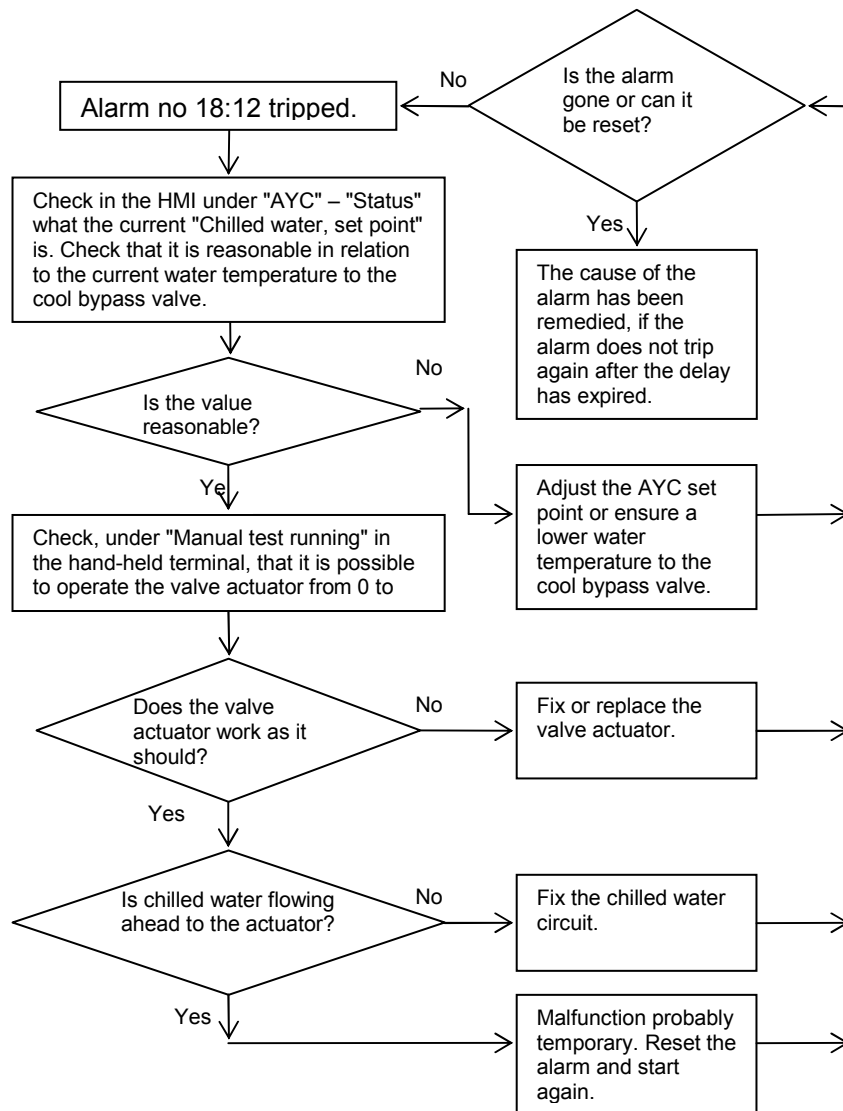

Fault tracing tripped alarm GOLD E			Document no.	Revision	Page
					87 (146)
			Date released	Supersedes	
Type of document	Drawn up by	Revised by	Released and published by		
Instruktion	Bertil Sjunnesson	Magnus Hallén			

2.15.11. Alarm no. 18:13 "AYC Heat, above set point alarm limit"

The alarm is enabled when the "All Year Comfort" function is activated for "Chilled water" or Chilled and heated water" and the alarm is manually activated under Alarm priority.

The alarms trip when the water temperature for AYC Cool is above the relevant alarm limit in relation to the set point for more than 20 minutes. Check that the preset alarm limit is appropriate.

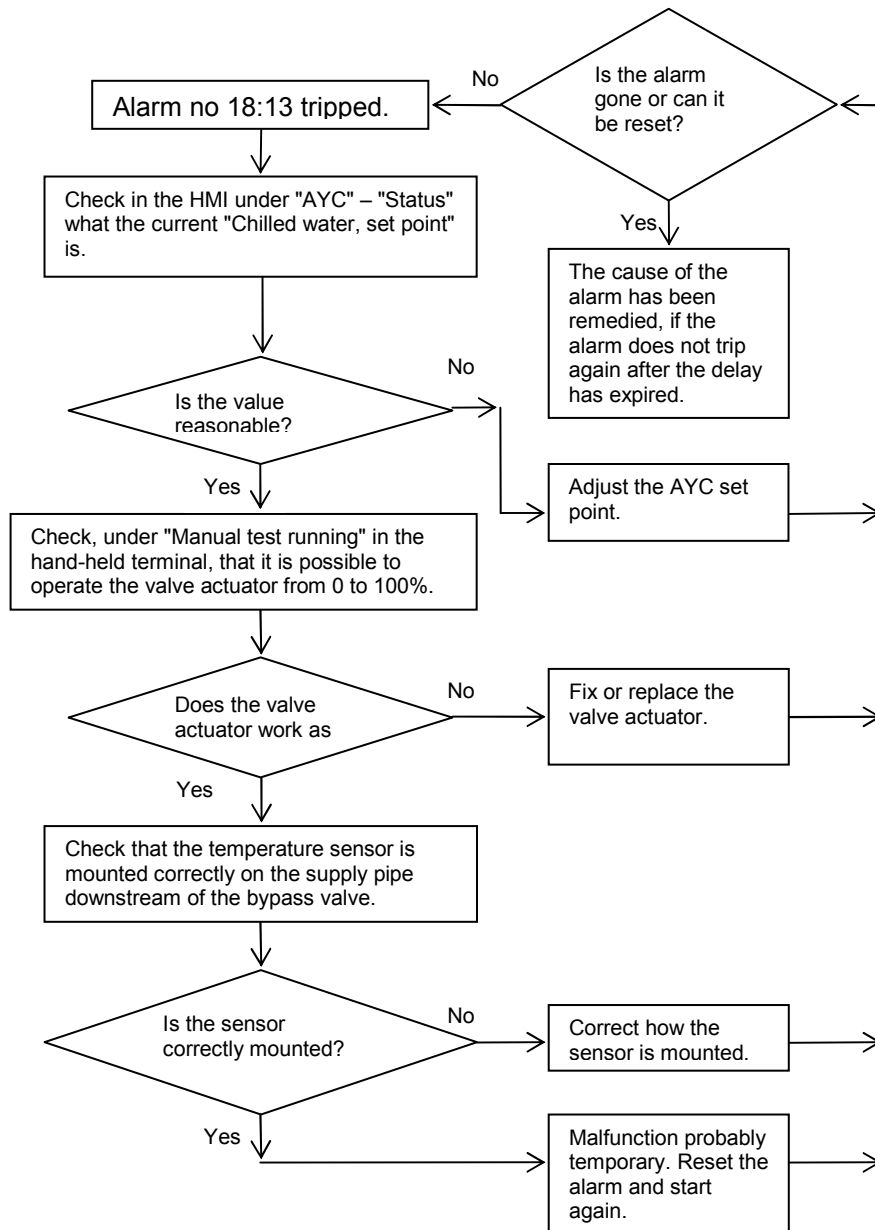

2.16. Alarm group 21: COOL DX

2.16.1. Alarm no. 21:1 "COOL DX, I/O module no. 2 communication error"

The alarm is enabled when the "COOL DX" cooling function is selected as "Economy", "Comfort" or "COOL DX Top".

Fault tracing tripped alarm GOLD E			Document no.	Revision	Page
					88 (146)
			Date released	Supersedes	
Type of document Instruktion	Drawn up by Bertil Sjunnesson	Revised by Magnus Hallén	Released and published by		

The alarm trips if the control unit does not achieve correct communication with the module.

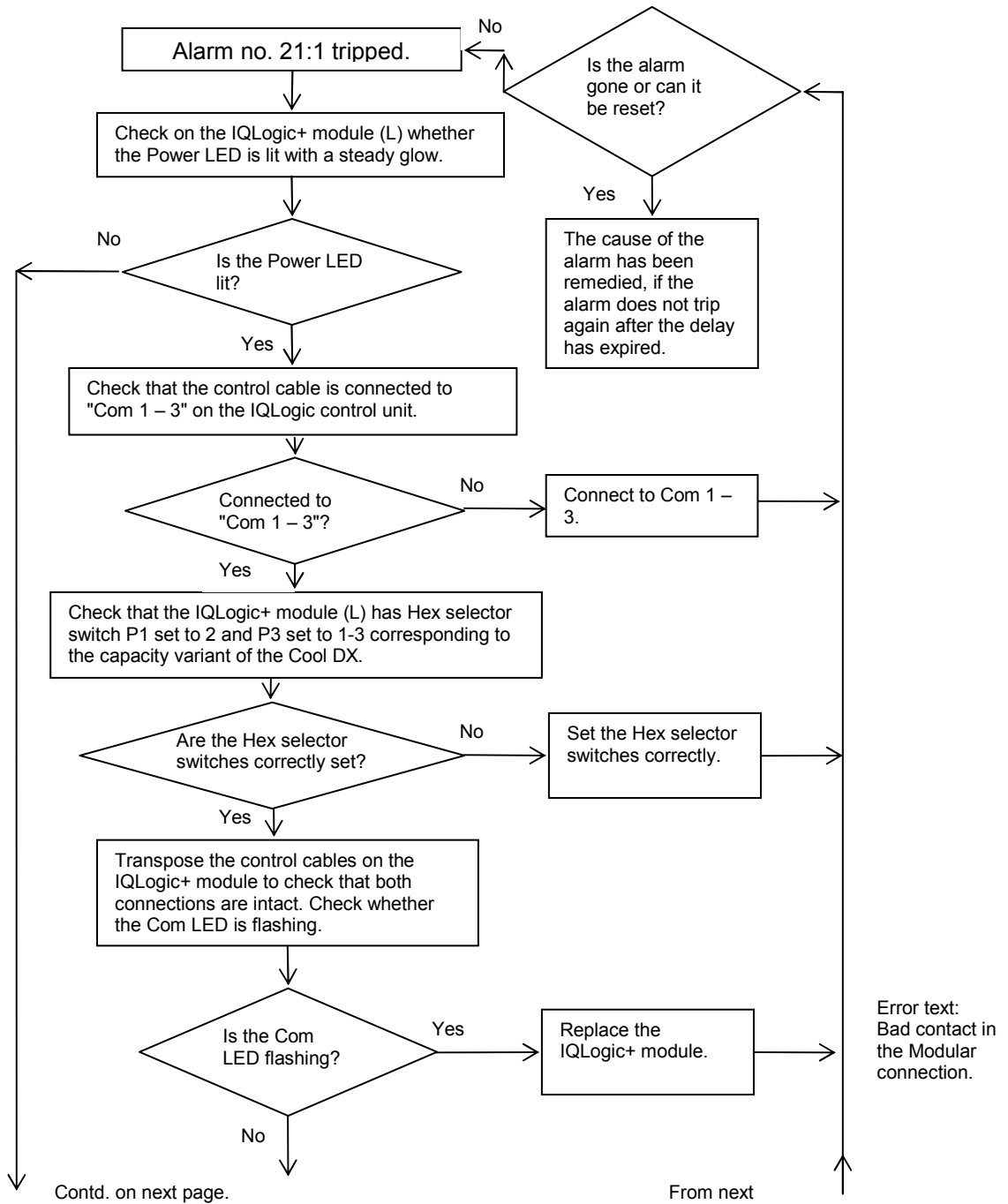

Fault tracing tripped alarm GOLD E			<i>Document no.</i>	<i>Revision</i>	<i>Page</i> 89 (146)
			<i>Date released</i>		<i>Supersedes</i>
<i>Type of document</i> Instruktion	<i>Drawn up by</i> Bertil Sjunnesson	<i>Revised by</i> Magnus Hallén	<i>Released and published by</i>		

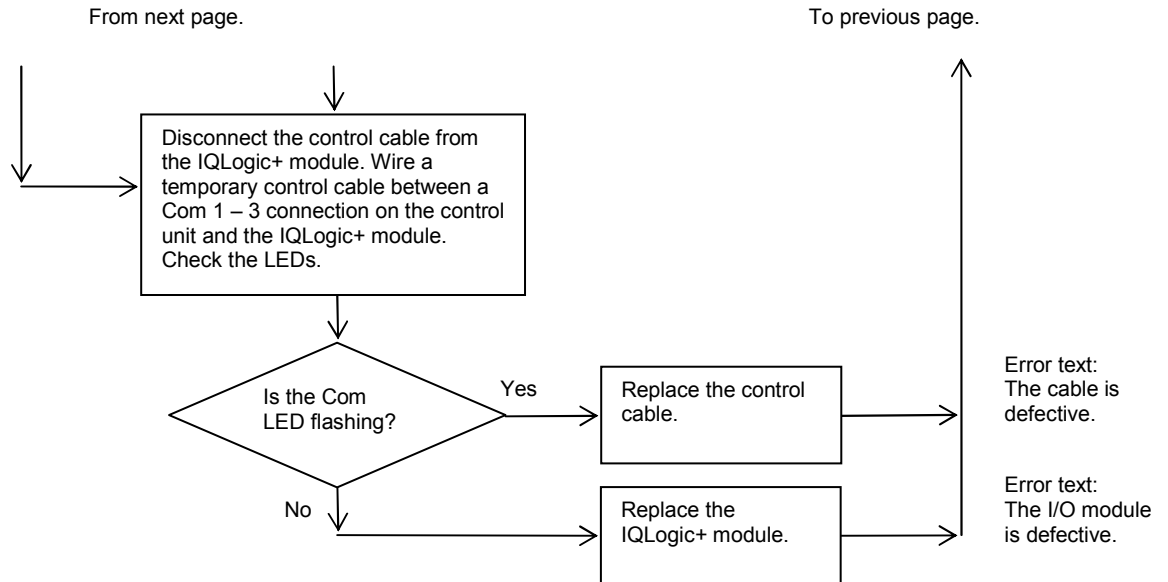

Fault tracing tripped alarm GOLD E			Document no.	Revision	Page 90 (146)
			Date released	Supersedes	
Type of document Instruktion	Drawn up by Bertil Sjunnesson	Revised by Magnus Hallén	Released and published by		

2.16.2. Alarm no. 21:2 "COOL DX, compressor 1, low pressure sensor defective"

The alarm is enabled when the "COOL DX" cooling function is selected as "Economy", Comfort" or "COOL DX Top".

The alarms trip when the signal from low pressure sensor B2:1 is < 0.2V DC.

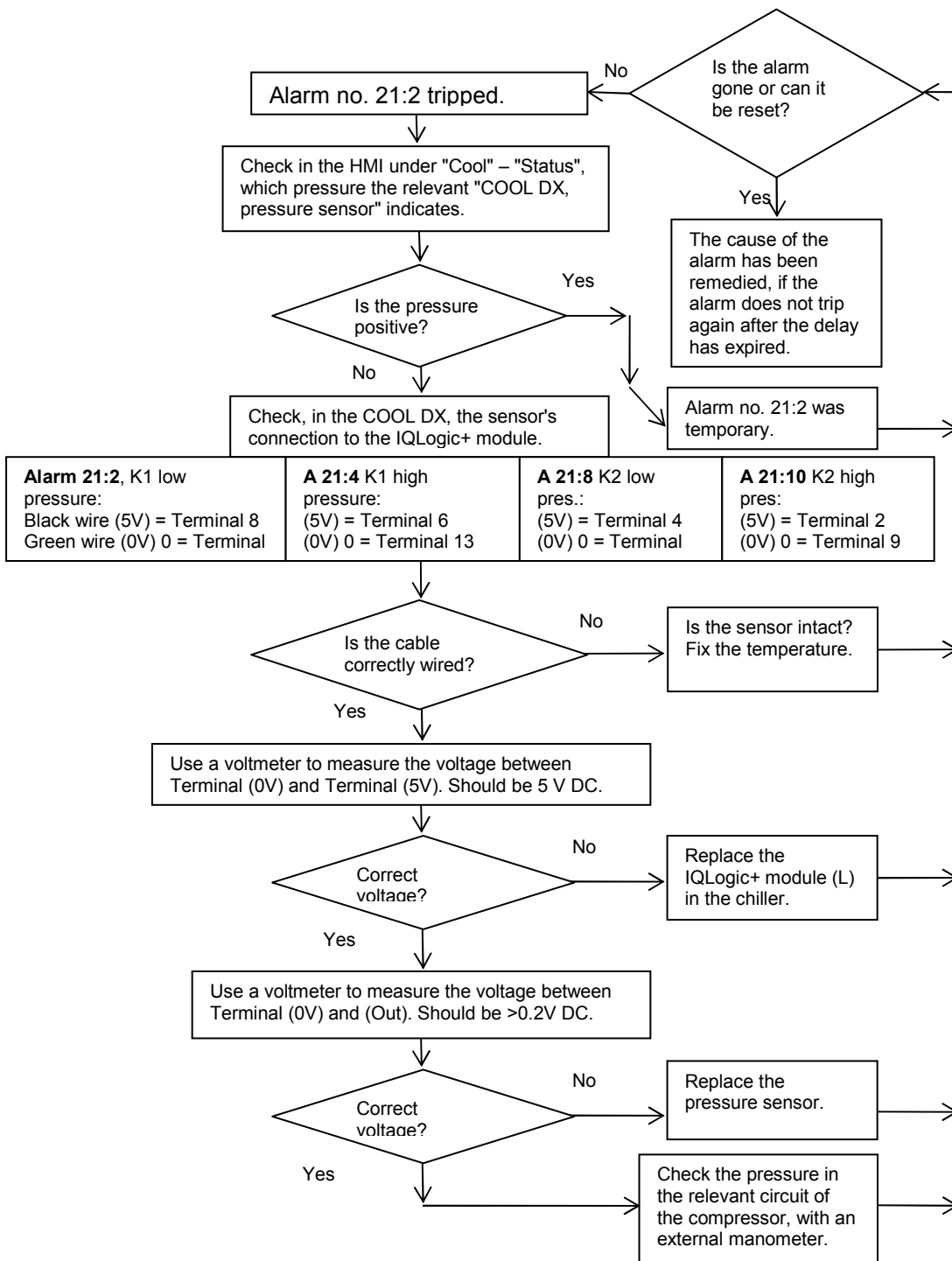

Fault tracing tripped alarm GOLD E			Document no.	Revision	Page
					91 (146)
			Date released	Supersedes	
Type of document	Drawn up by	Revised by	Released and published by		
Instruktion	Bertil Sjunnesson	Magnus Hallén			

2.16.3. Alarm no. 21:3 "COOL DX, compressor 1, low pressure sensor below alarm limit"

The alarm is enabled when the "COOL DX" cooling function is selected as "Economy", "Comfort" or "COOL DX Top".

The alarms trip when the signal from low pressure sensor B2:1 is below the preset alarm limit (3.0 bar = 0.8V DC).

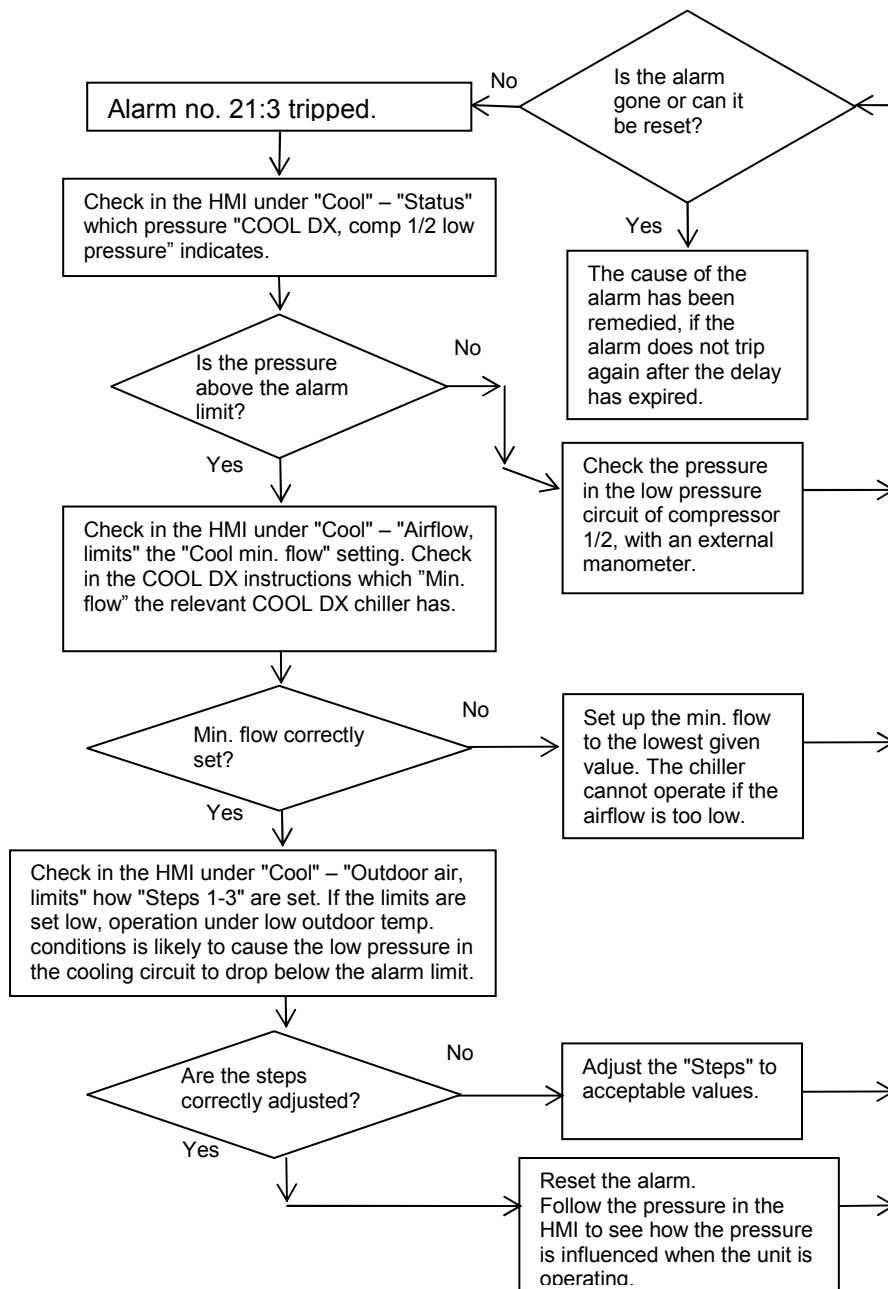

Fault tracing tripped alarm GOLD E			Document no.	Revision	Page
					92 (146)
			Date released	Supersedes	
Type of document	Drawn up by	Revised by	Released and published by		
Instruktion	Bertil Sjunnesson	Magnus Hallén			

2.16.4. Alarm no. 21:4 "COOL DX, compressor 1, high pressure sensor defective"

The alarm is enabled when the "COOL DX" cooling function is selected as "Economy", Comfort" or "COOL DX Top".

The alarms trip when the signal from low pressure sensor B1:1 is < 0.2V DC.

For troubleshooting see Alarm no. 21:2 above.

2.16.5. Alarm no. 21:5 "COOL DX, compressor 1, high pressure sensor above alarm limit"

The alarm is enabled when the "COOL DX" cooling function is selected as "Economy", Comfort" or "COOL DX Top".

The alarms trip when the signal from low pressure sensor B1:1 is above the preset alarm limit (40.5 bar = 4.1V DC).

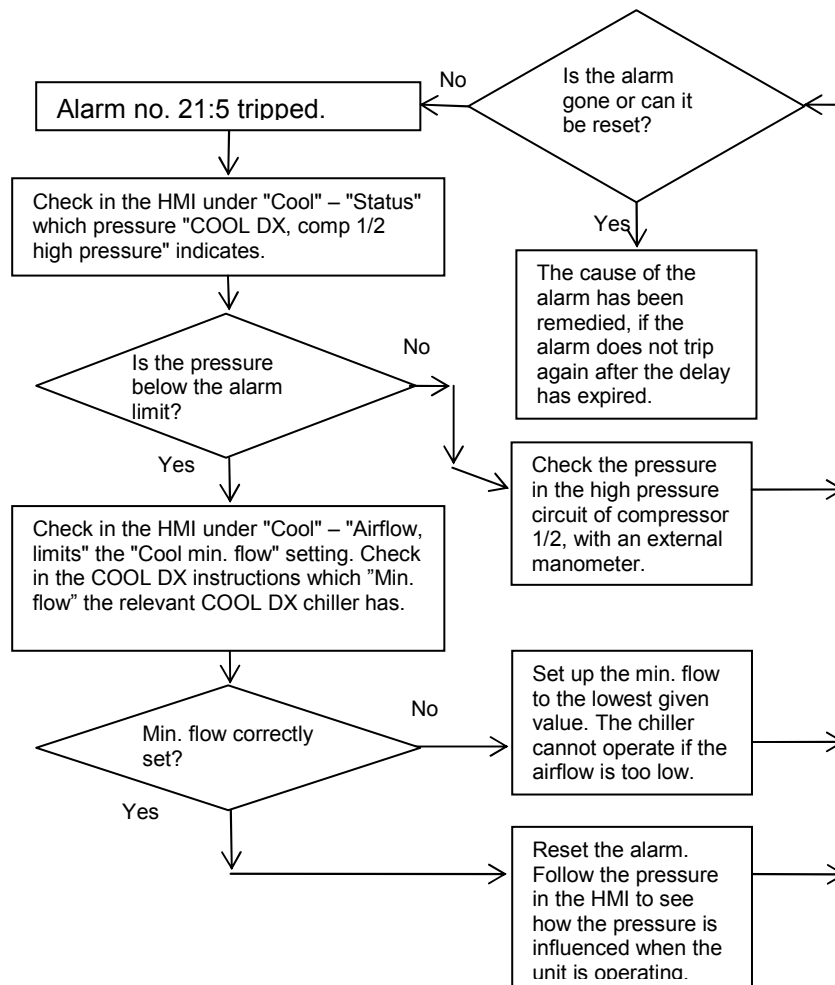

Fault tracing tripped alarm GOLD E			Document no.	Revision	Page
					93 (146)
			Date released	Supersedes	
Type of document	Drawn up by	Revised by	Released and published by		
Instruktion	Bertil Sjunnesson	Magnus Hallén			

2.16.6. Alarm no. 21:6 "COOL DX, compressor 1, monitoring tripped"

The alarm is enabled when the "COOL DX" cooling function is selected as "Economy", "Comfort" or "COOL DX Top".

The alarms trip for COOL DX when the control unit does not detect that the feedback on the digital input corresponds to the signal on the digital output.

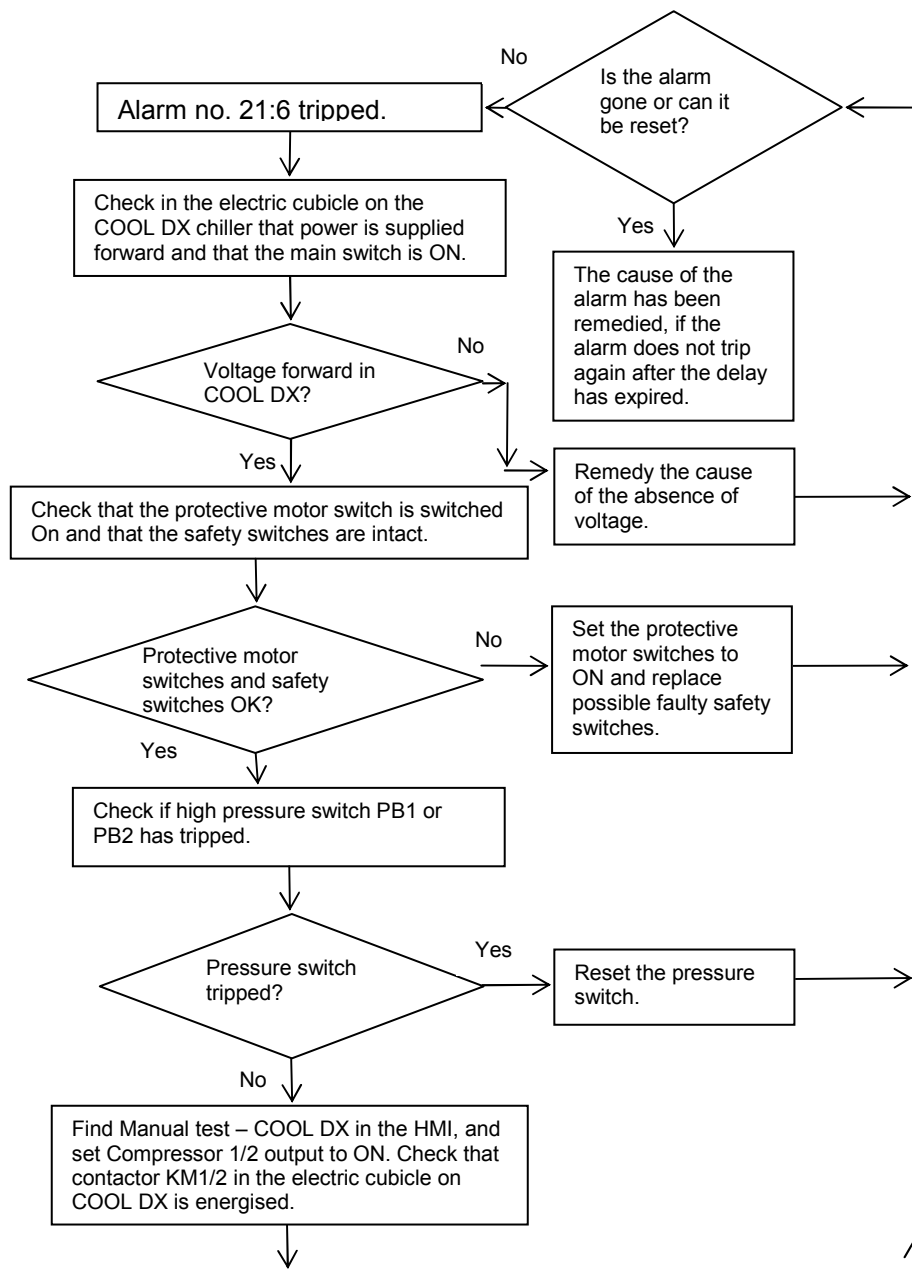

Contd. on next page.

From next page.

Fault tracing tripped alarm GOLD E			Document no.	Revision	Page
					94 (146)
			Date released	Supersedes	
Type of document	Drawn up by	Revised by	Released and published by		
Instruktion	Bertil Sjunnesson	Magnus Hallén			

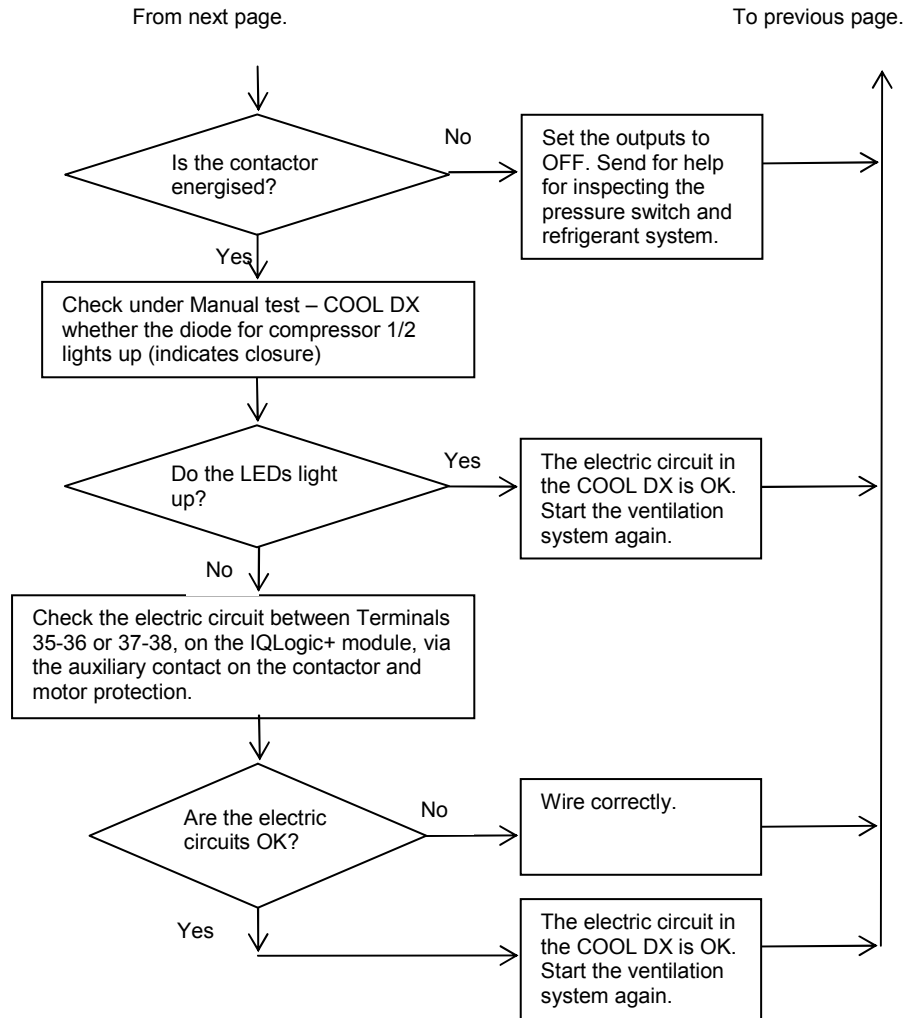

Fault tracing tripped alarm GOLD E			Document no.	Revision	Page
					95 (146)
			Date released	Supersedes	
Type of document	Drawn up by	Revised by	Released and published by		
Instruktion	Bertil Sjunnesson	Magnus Hallén			

2.16.7. Alarm no. 21:7 "COOL DX, compressor 1, restart error"

The alarm is enabled when the "COOL DX" cooling function is selected as "Economy", "Comfort" or "COOL DX Top".

The alarms trip when the control unit, due to a in-operation pressure switch stop, has restarted cooling compressor 1 more than 10 times in 1 hour.

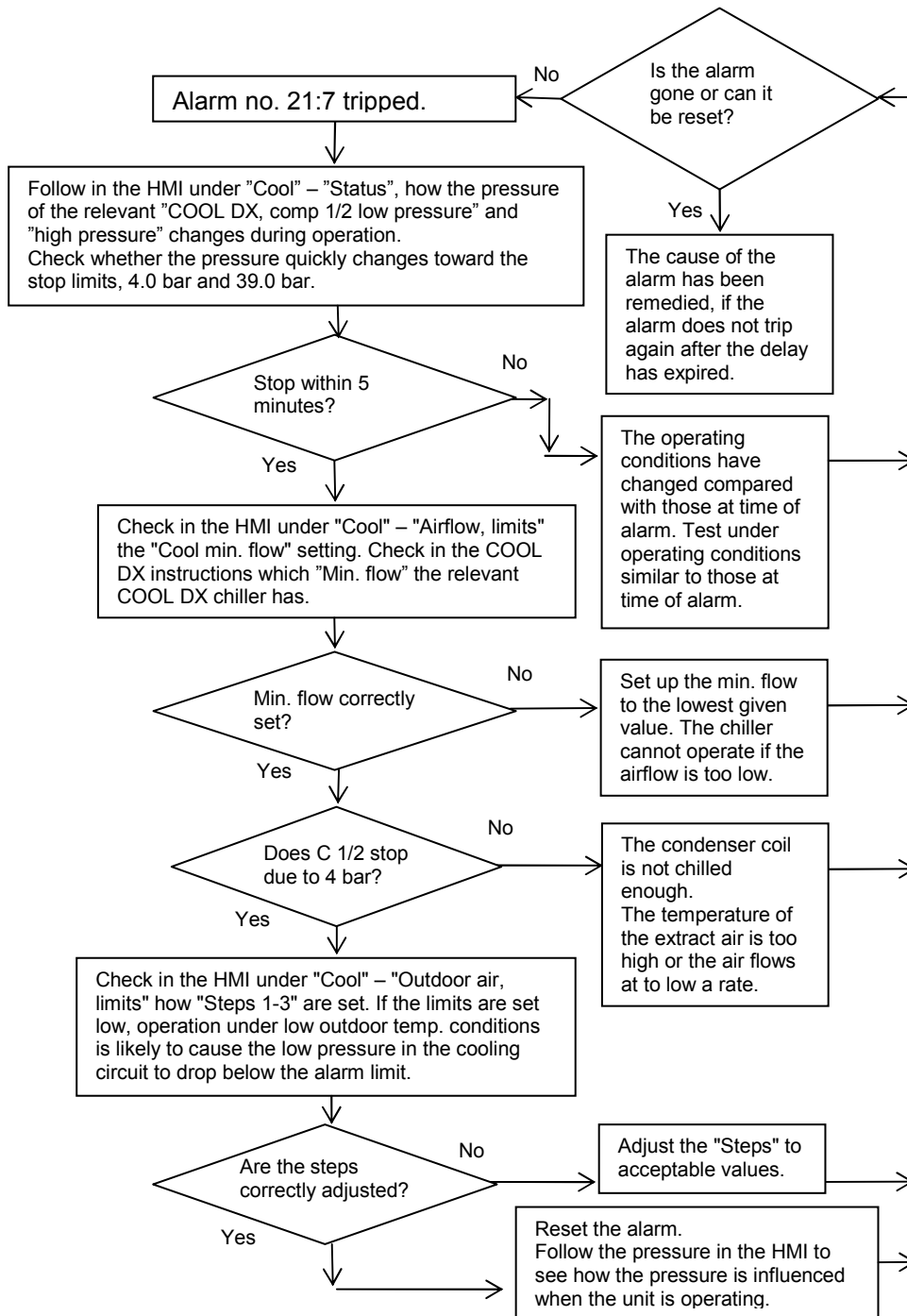

Fault tracing tripped alarm GOLD E			<i>Document no.</i>	<i>Revision</i>	<i>Page</i>
					96 (146)
			<i>Date released</i>	<i>Supersedes</i>	
<i>Type of document</i>	<i>Drawn up by</i>	<i>Revised by</i>	<i>Released and published by</i>		
Instruktion	Bertil Sjunnesson	Magnus Hallén			

2.16.8. Alarm no. 21:8 "COOL DX, compressor 2, low pressure sensor defective"

The alarm is enabled when the "COOL DX" cooling function is selected as "Economy", Comfort" or "COOL DX Top".

The alarms trip when the signal from low pressure sensor B2:2 is < 0.2V DC.

For troubleshooting see Alarm no. 21:2 above.

2.16.9. Alarm no. 21:9 "COOL DX, compressor 2, low pressure sensor below alarm limit"

The alarm is enabled when the "COOL DX" cooling function is selected as "Economy", Comfort" or "COOL DX Top".

The alarms trip when the signal from low pressure sensor B2:2 is below the preset alarm limit (3.0 bar = 0.8V DC).

For troubleshooting see Alarm no. 21:3 above.

2.16.10. Alarm no. 21:10 "COOL DX, compressor 2, high pressure sensor defective"

The alarm is enabled when the "COOL DX" cooling function is selected as "Economy", Comfort" or "COOL DX Top".

The alarms trip when the signal from low pressure sensor B1:2 is < 0.2V DC.

For troubleshooting see Alarm no. 21:2 above.

2.16.11. Alarm no. 21:11 "COOL DX, compressor 2, high pressure sensor above alarm limit"

The alarm is enabled when the "COOL DX" cooling function is selected as "Economy", Comfort" or "COOL DX Top".

The alarms trip when the signal from low pressure sensor B1:2 is above the preset alarm limit (40.5 bar = 4.1V DC).

For troubleshooting see Alarm no. 21:5 above.

2.16.12. Alarm no. 21:12 "COOL DX, compressor 2, monitoring tripped"

The alarm is enabled when the "COOL DX" cooling function is selected as "Economy", Comfort" or "COOL DX Top".

The alarms trip for COOL DX when the control unit does not detect that the feedback on the digital input corresponds to the signal on the digital output.

For troubleshooting see Alarm no. 21:2 above.

2.16.13. Alarm no. 21:13 "COOL DX, compressor 2, restart error"

The alarm is enabled when the "COOL DX" cooling function is selected as "Economy", Comfort" or "COOL DX Top".

The alarms trip when the control unit, due to a in-operation pressure switch stop, has restarted cooling compressor 1 more than 10 times in 1 hour.

For troubleshooting see Alarm no. 21:7 above.

Fault tracing tripped alarm GOLD E			Document no.	Revision	Page
					97 (146)
			Date released	Supersedes	
Type of document	Drawn up by	Revised by	Released and published by		
Instruktion	Bertil Sjunnesson	Magnus Hallén			

2.16.14. Alarm no. 21:14 "COOL DX, outdoor temperature sensor defective"

The alarm is enabled when the "COOL DX" cooling function is selected as "Economy", Comfort" or "COOL DX Top".

The alarms trip when the control unit does not achieve communication with the temperature sensor or when the sensor measures temperatures outside the range of measurement (-55°C – 125°C).

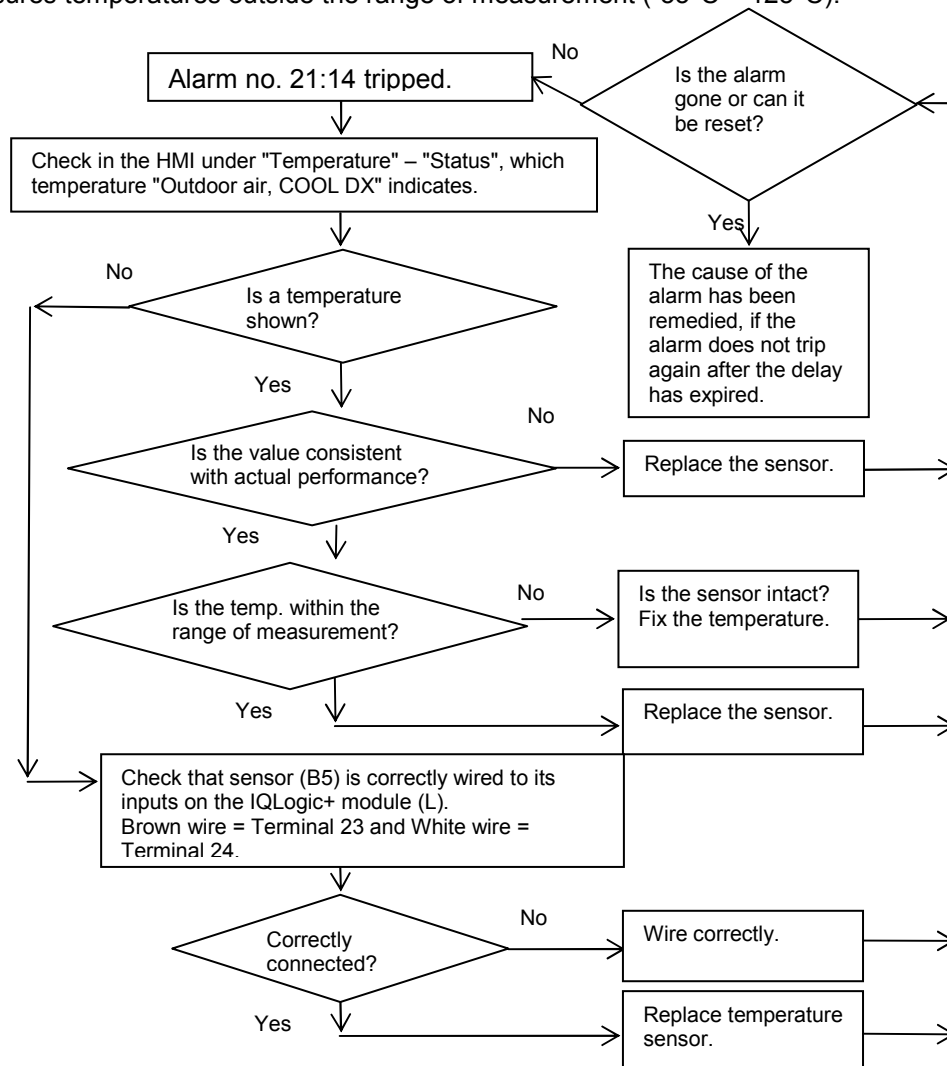

2.16.15. Alarm no. 21:15 "COOL DX, phase sequence monitor tripped"

The alarm is enabled when the "COOL DX" cooling function is selected as "Economy", Comfort" or "COOL DX Top".

The alarms trip when the PSC relay, which monitors the phase sequence on incoming power, initiates an alarm due to wrong phase sequence.

Check that there is voltage on all 3 incoming phases.

Check that the main switch is set to ON.

Check that all the safety switches and protective motor switches are switched on.

Perform a test by switching the order of two of the incoming phases Important! Isolate the power supply in the relevant electrical distribution box.

Fault tracing tripped alarm GOLD E			Document no.	Revision	Page
					98 (146)
			Date released	Supersedes	
Type of document	Drawn up by	Revised by	Released and published by		
Instruktion	Bertil Sjunnesson	Magnus Hallén			

2.17. Alarm group 23: SMART LINK

2.17.1. Alarm 23:1 "SMART Link, communication error"

The alarm is enabled when any of the "SMART Link" functions is selected.
The alarm trips if the control unit does not achieve correct communication with the Blue Box unit.

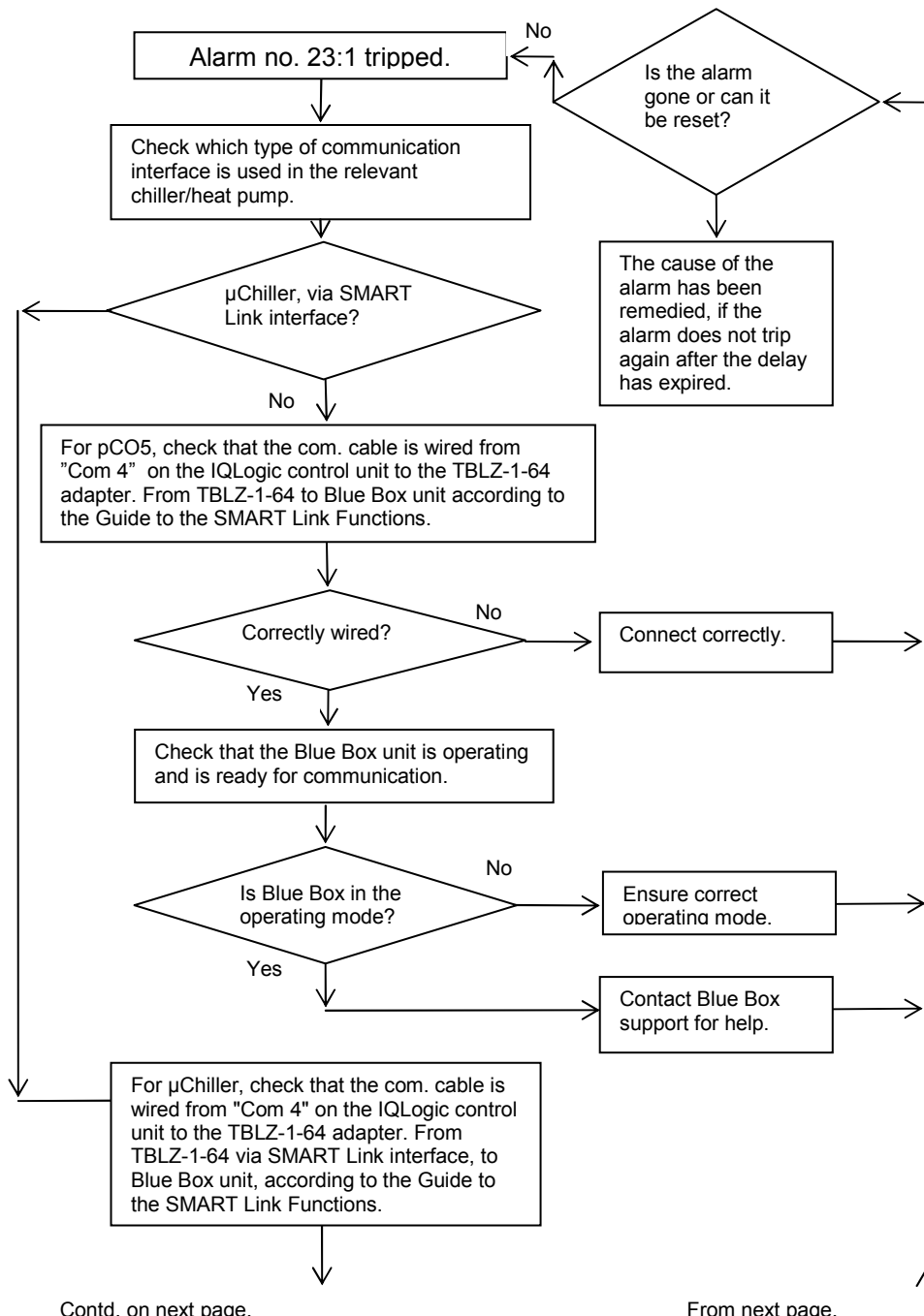

Fault tracing tripped alarm GOLD E			<i>Document no.</i>	<i>Revision</i>	<i>Page</i>
					99 (146)
			<i>Date released</i>	<i>Supersedes</i>	
<i>Type of document</i> Instruktion	<i>Drawn up by</i> Bertil Sjunnesson	<i>Revised by</i> Magnus Hallén	<i>Released and published by</i>		

From next page.

To previous page.

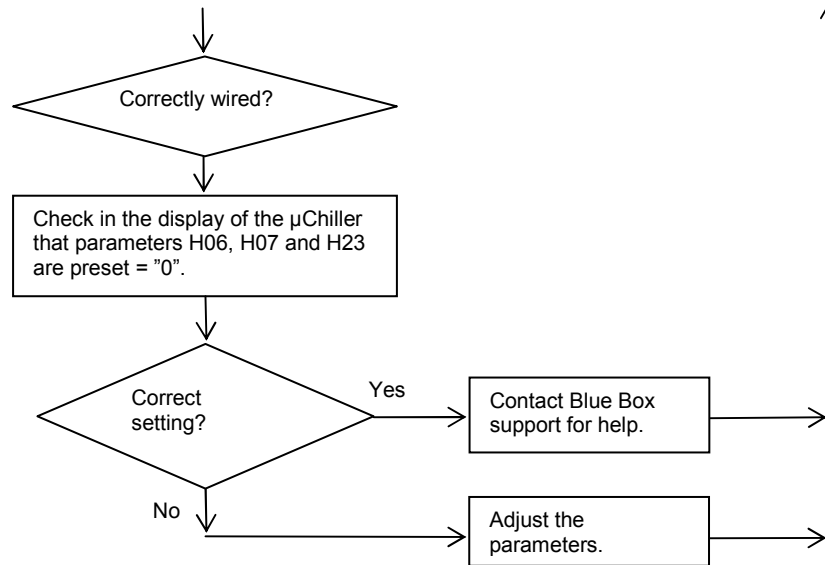

Fault tracing tripped alarm GOLD E			<i>Document no.</i>	<i>Revision</i>	<i>Page</i>
					100 (146)
			<i>Date released</i>	<i>Supersedes</i>	
<i>Type of document</i>	<i>Drawn up by</i>	<i>Revised by</i>	<i>Released and published by</i>		
Instruktion	Bertil Sjunnesson	Magnus Hallén			

2.17.2. Alarm no. 23:2-4 "SMART Link, alarm levels 1-3 tripped"

The alarm is enabled when any of the "SMART Link" functions is selected.

The alarms trip when some malfunction has arisen in the Blue Box control system and the Blue Box control system transmits information via communication to the IQLogic control unit.

Check in the Blue Box control system which alarm has tripped.

2.17.3. Alarm no. 23:10 "AQUA Link, I/O module no. 5 communication error"

The alarm is enabled when the "SMART Link" functions are selected for "Water, chiller" and the AQUA Link function is selected = On.

The alarm trips when the control unit does not achieve correct communication with IQLogic+ module 5 (S), located in the AQUA Link electrical cubicle.

For troubleshooting see Alarm no. 3:1 above.

2.17.4. Alarm no. 23:10 "AQUA Link, I/O module no. 5 communication error"

The alarm is enabled when the "SMART Link" functions are selected for "Water, chiller", the AQUA Link function is selected = On and the pump alarm is enabled.

The alarm trips when the current status on the alarm input (closed or open), on Terminals 11-12 on IQLogic+ module 5 (S) in the AQUA Link enclosure correspond to the selected alarm function.

Optional functions: "Alarm on open contact", "Alarm on closed contact" and "Contactor function".

Contactor function means that the alarm input must close within 3 seconds after the Pump output has been energised. Used when a contactor is used for controlling the pump.

- Check under "SMART Link" – "Status" the status of the "AQUA Link, pump output" and "AQUA Link, alarm input".

2.17.5. Alarm no. 23:11 "AQUA Link, pump monitoring tripped"

The alarm is enabled when the "SMART Link" functions are selected for "Water, chiller". The AQUA Link function is selected = On, and the pump alarm is enabled.

The alarm trips when the current status on the alarm input (closed or open), on Terminals 11-12 on IQLogic+ module 5 (S) in the AQUA Link enclosure, correspond to the selected alarm function.

Optional functions: "Alarm at open contact", "Alarm at closed contact" and "Contactor function".

Contactor function means that the alarm input must close within 3 seconds after the Pump output has been energised. The function is used when a contactor is used for controlling the pump. An alarm is also initiated if the alarm input is closed when the pump should not be in operation.

- Check under "SMART Link – Status" the status of the "AQUA Link, pump output" and "AQUA Link, alarm input".

Fault tracing tripped alarm GOLD E			Document no.	Revision	Page
					101 (146)
			Date released	Supersedes	
Type of document	Drawn up by	Revised by	Released and published by		
Instruktion	Bertil Sjunnesson	Magnus Hallén			

2.18. Alarm group 24: SMART LINK, DX

2.18.1. Alarm no. 24:1 "SMART Link, no. 1 communication error"

The alarm is enabled when any of the "SMART Link, DX" functions is selected.

The alarm trips if the IQLogic control unit does not achieve correct communication with DX chiller no. 1.

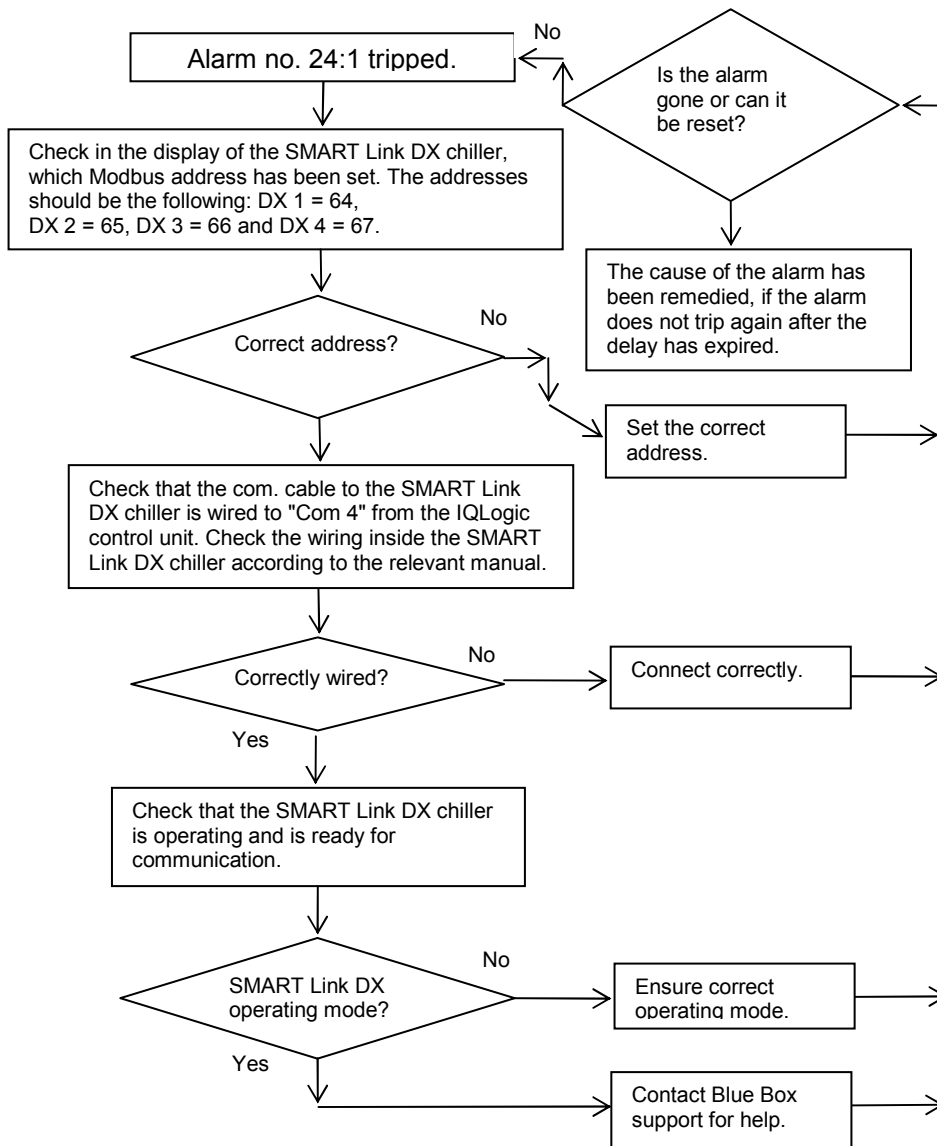

2.18.2. Alarm no. 24:2 "SMART Link, no. 1 tripped"

The alarm is enabled when any of the "SMART Link DX" functions is selected.

Fault tracing tripped alarm GOLD E			<i>Document no.</i>	<i>Revision</i>	<i>Page</i> 102 (146)
			<i>Date released</i>		<i>Supersedes</i>
<i>Type of document</i> Instruktion	<i>Drawn up by</i> Bertil Sjunnesson	<i>Revised by</i> Magnus Hallén	<i>Released and published by</i>		

The alarms trip when some malfunction has arisen in "SMART Link DX no. 1" and the "SMART Link no. 1" control unit transmits common fault alarm information via communication to the IQLogic control unit. Check in the "SMART Link no.1" control system which alarm has tripped

2.18.3. Alarm no. 24:4 "SMART Link, no. 2 communication error"

The alarm is enabled when one of the "SMART Link, DX " functions is selected and 2 is selected as "Number of connected units".

The alarm trips if the IQLogic control unit does not achieve correct communication with DX chiller no. 2. For troubleshooting see Alarm no. 24:1 above.

2.18.4. Alarm no. 24:5 "SMART Link, no. 2 tripped"

The alarm is enabled when one of the "SMART Link, DX" functions is selected and 2 is selected as "Number of connected units".

The alarms trip when some malfunction has arisen in "SMART Link DX no. 2" and the "SMART Link no. 2" control unit transmits common fault alarm information via communication to the IQLogic control unit. Check in the "SMART Link no.2" control system which alarm has tripped

2.18.5. Alarm no. 24:7 "SMART Link, no. 3 communication error"

The alarm is enabled when one of the "SMART Link, DX " functions is selected and 3 is selected as "Number of connected units".

The alarm trips if the IQLogic control unit does not achieve correct communication with DX chiller no. 3. For troubleshooting see Alarm no. 24:1 above.

2.18.6. Alarm no. 24:8 "SMART Link, no. 3 tripped"

The alarm is enabled when one of the "SMART Link, DX" functions is selected and 3 is selected as "Number of connected units".

The alarms trip when some malfunction has arisen in "SMART Link DX no. 3" and the "SMART Link no. 3" control unit transmits common fault alarm information via kommunikationen to the IQLogic control unit. Check in the "SMART Link no. 3" control system which alarm has tripped

2.18.7. Alarm no. 24:10 "SMART Link, no. 4 communication error"

The alarm is enabled when one of the "SMART Link, DX " functions is selected and 4 is selected as "Number of connected units".

The alarm trips if the IQLogic control unit does not achieve correct communication with DX chiller no. 4. For troubleshooting see Alarm no. 24:1 above.

2.18.8. Alarm no. 24:8 "SMART Link, no. 4 tripped"

The alarm is enabled when one of the "SMART Link, DX" functions is selected and 4 is selected as "Number of connected units".

The alarms trip when some malfunction has arisen in "SMART Link DX no. 4" and the "SMART Link no. 4" control unit transmits common fault alarm information via communication to the IQLogic control unit. Check in the "SMART Link no. 4" control system which alarm has tripped

Fault tracing tripped alarm GOLD E			Document no.	Revision	Page
					103 (146)
			Date released	Supersedes	
Type of document	Drawn up by	Revised by	Released and published by		
Instruktion	Bertil Sjunnesson	Magnus Hallén			

2.19. Alarm group 26: PRE-FILTERS

2.19.1. Alarm no. 26:1 "Pre-filter, supply air pressure sensor no. 8 communication error".

The alarm is enabled when the "Pre-filter" function is selected for "Supply air" or "Supply and extract air". The alarm trips if the control unit does not achieve correct communication with pressure sensor no. 8.

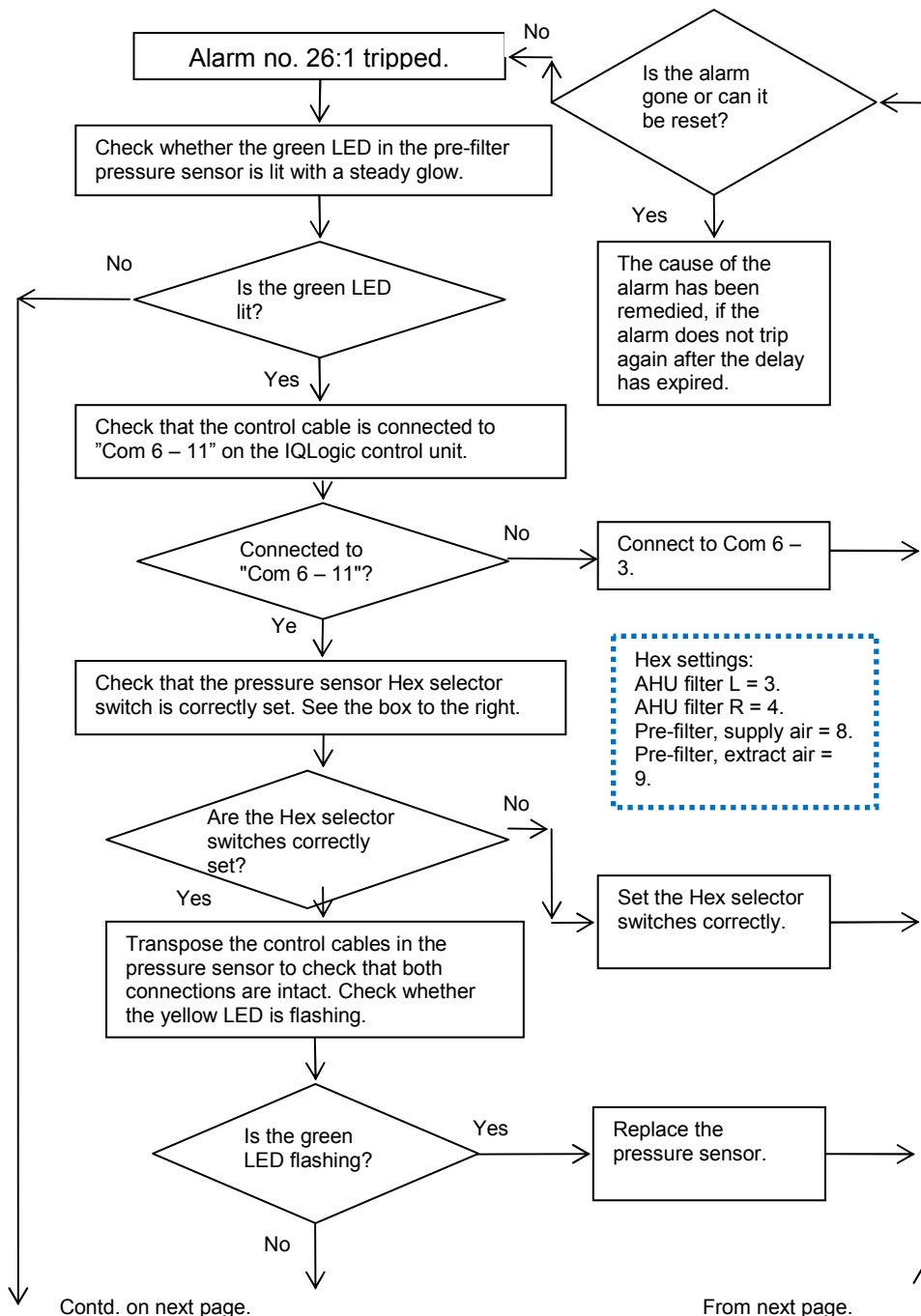

Fault tracing tripped alarm GOLD E			<i>Document no.</i>	<i>Revision</i>	<i>Page</i>
					104 (146)
			<i>Date released</i>	<i>Supersedes</i>	
<i>Type of document</i> Instruktion	<i>Drawn up by</i> Bertil Sjunnesson	<i>Revised by</i> Magnus Hallén	<i>Released and published by</i>		

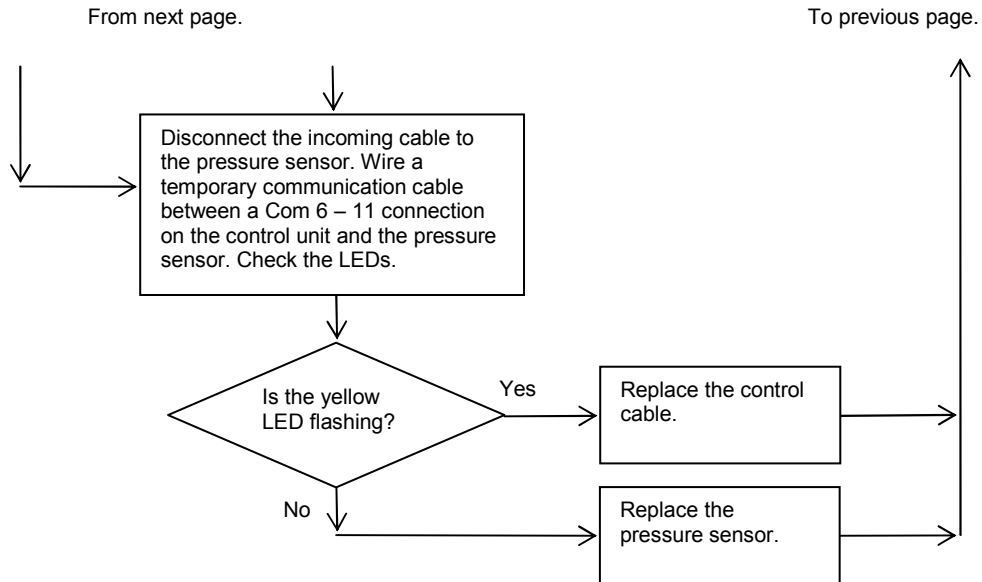

Fault tracing tripped alarm GOLD E			Document no.	Revision	Page
					105 (146)
			Date released	Supersedes	
Type of document	Drawn up by	Revised by	Released and published by		
Instruktion	Bertil Sjunnesson	Magnus Hallén			

2.19.2. Alarm no. 26:2 "Pre-filter, supply air, dirty"

The alarm is enabled when the "Pre-filter" function is selected for "Supply air" or "Supply and extract air" and the flow through the supply air filter is more than half the flow being used for filter calibration. The alarms trip when the pressure drop across the filter has been above the alarm limit for more than 10 minutes at a stretch.

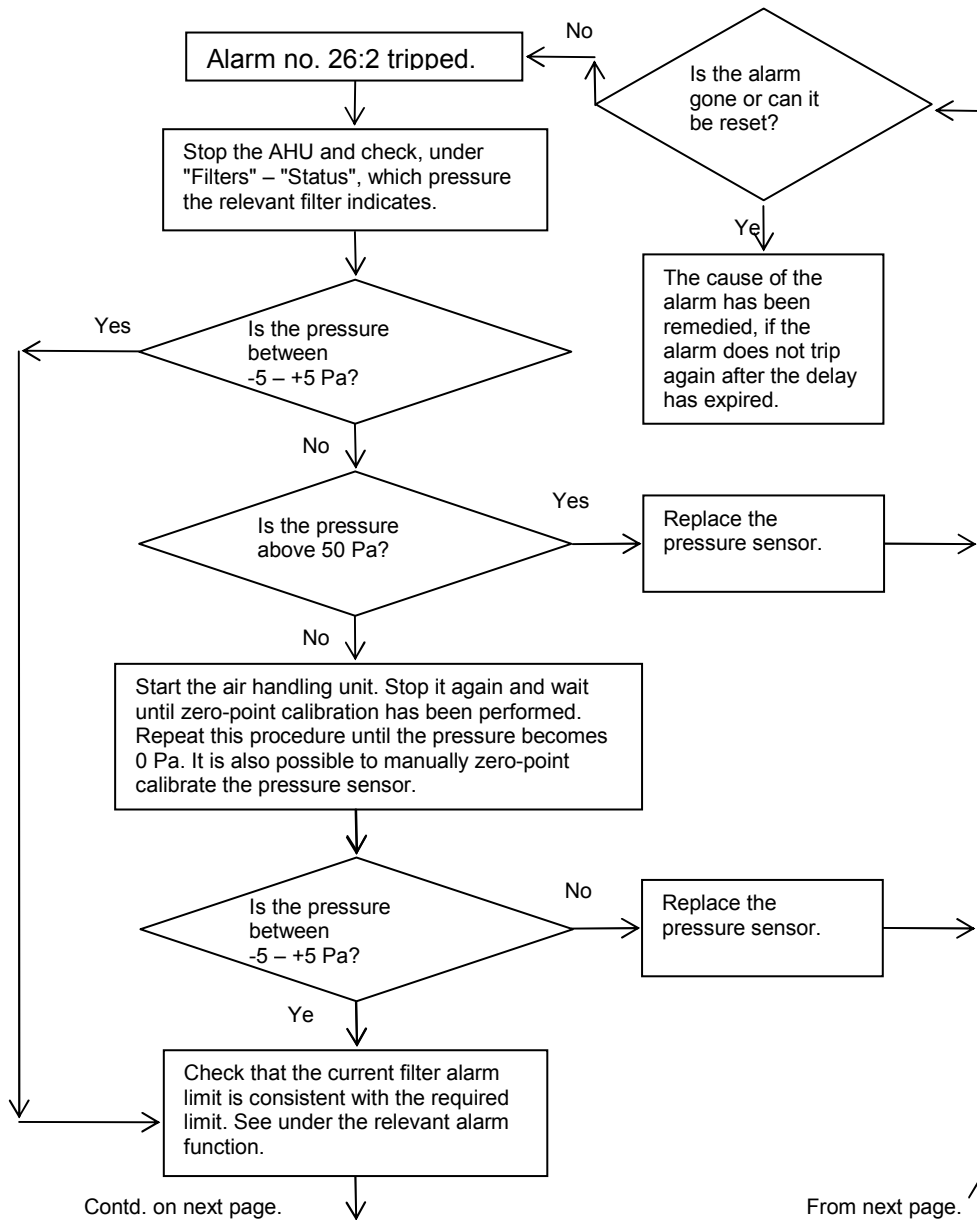

Fault tracing tripped alarm GOLD E			Document no.	Revision	Page
					106 (146)
			Date released	Supersedes	
Type of document	Drawn up by	Revised by	Released and published by		
Instruktion	Bertil Sjunnesson	Magnus Hallén			

From next page.

To previous page.

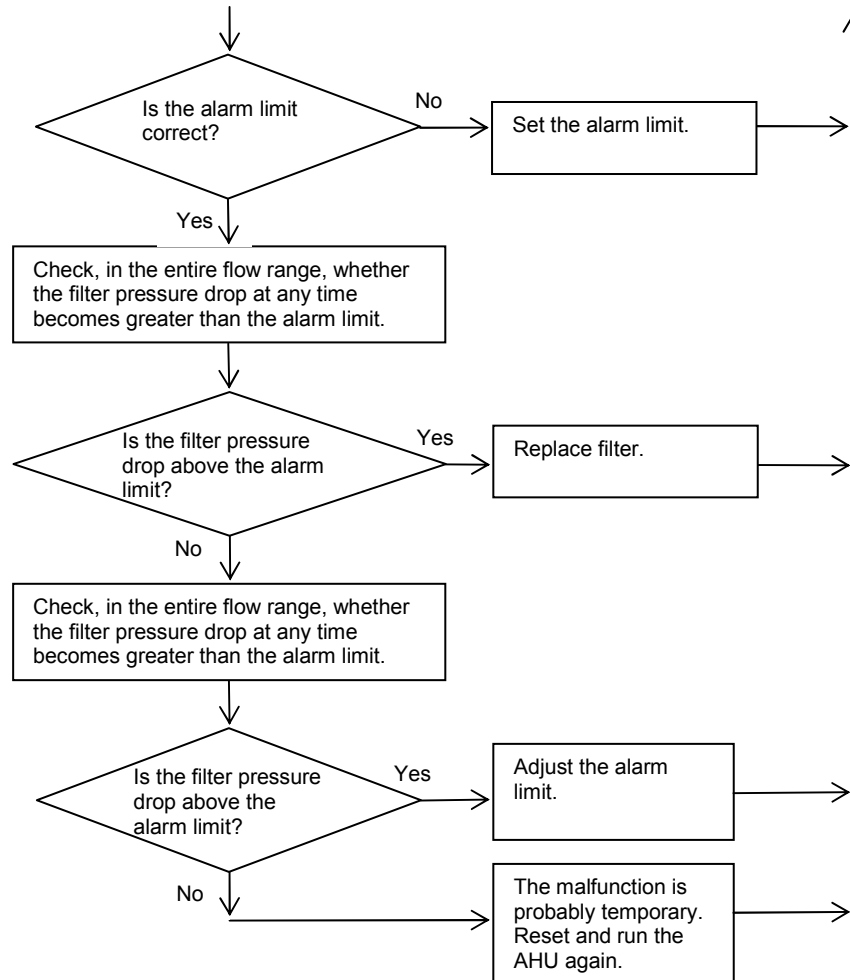

Fault tracing tripped alarm GOLD E			<i>Document no.</i>	<i>Revision</i>	<i>Page</i>
					107 (146)
			<i>Date released</i>	<i>Supersedes</i>	
<i>Type of document</i>	<i>Drawn up by</i>	<i>Revised by</i>	<i>Released and published by</i>		
Instruktion	Bertil Sjunnesson	Magnus Hallén			

2.19.3. Alarm no. 26:7 "Pre-filter, extract air pressure sensor no. 9 communication error".

The alarm is enabled when the "Pre-filter" function is selected for "Extract air" or "Supply and extract air".
The alarm trips if the control unit does not achieve correct communication with pressure sensor no. 9.

For troubleshooting see Alarm no. 26:1 above.

2.19.4. Alarm no. 26:8 "Pre-filter, extract air, dirty"

The alarm is enabled when the "Pre-filter" function is selected for "Extract air" or "Supply and extract air" and the flow through the supply air filter is more than half the flow used for filter calibration.

The alarms trip when the pressure drop across the filter has been above the alarm limit for more than 10 minutes at a stretch.

For troubleshooting see Alarm no. 26:2 above.

Fault tracing tripped alarm GOLD E			<i>Document no.</i>	<i>Revision</i>	<i>Page</i>
					108 (146)
			<i>Date released</i>	<i>Supersedes</i>	
<i>Type of document</i>	<i>Drawn up by</i>	<i>Revised by</i>	<i>Released and published by</i>		
Instruktion	Bertil Sjunnesson	Magnus Hallén			

2.20. Alarm group 27: AIR HANDLING UNIT FILTERS

2.20.1. Alarm no. 27:1 "Air handling unit filter, supply air pressure sensor no. 3/4, communication error"

The alarm is always enabled for the GOLD RX, PX and CX units.

The alarm trips if the control unit does not achieve correct communication with the pressure sensor for the supply air filter.

If the filter's location inside the AHU is to the left = Address 3 and to the right = Address 4.

For troubleshooting see Alarm no. 26:1 above.

2.20.2. Alarm no. 27:2 "Air handling unit filter, supply air, dirty"

The alarm is always enabled for GOLD RX, PX and CX units and the flow through the supply air filter is more than half the flow used for filter calibration.

The alarms trip when the pressure drop across the filter has been above the alarm limit for more than 10 minutes at a stretch.

For troubleshooting see Alarm no. 26:2 above.

2.20.3. Alarm no. 27:7 "Air handling unit filter, extract air pressure sensor no. 3/4, communication error"

The alarm is always enabled for the GOLD RX, PX and CX units.

The alarm trips if the control unit does not achieve correct communication with the pressure sensor for the extract air filter.

If the filter's location inside the AHU is to the left = Address 3 and to the right = Address 4.

For troubleshooting see Alarm no. 26:1 above.

2.20.4. Alarm no. 27:8 "Air handling unit filter, extract air, dirty"

The alarm is always enabled for GOLD RX, PX and CX units and the flow through the supply air filter is more than half the flow used for filter calibration.

The alarms trip when the pressure drop across the filter has been above the alarm limit for more than 10 minutes at a stretch.

For troubleshooting see Alarm no. 26:2 above.

Fault tracing tripped alarm GOLD E			Document no.	Revision	Page
					109 (146)
			Date released	Supersedes	
Type of document	Drawn up by	Revised by	Released and published by		
Instruktion	Bertil Sjunnesson	Magnus Hallén			

2.21. Alarm group 28: END FILTERS

2.21.1. Alarm no. 28:1 "End filter, supply air pressure sensor no. A communication error".

The alarm is enabled when the End filter function is activated.

The alarm trips if the control unit does not achieve correct communication with the pressure sensor for the end filter.

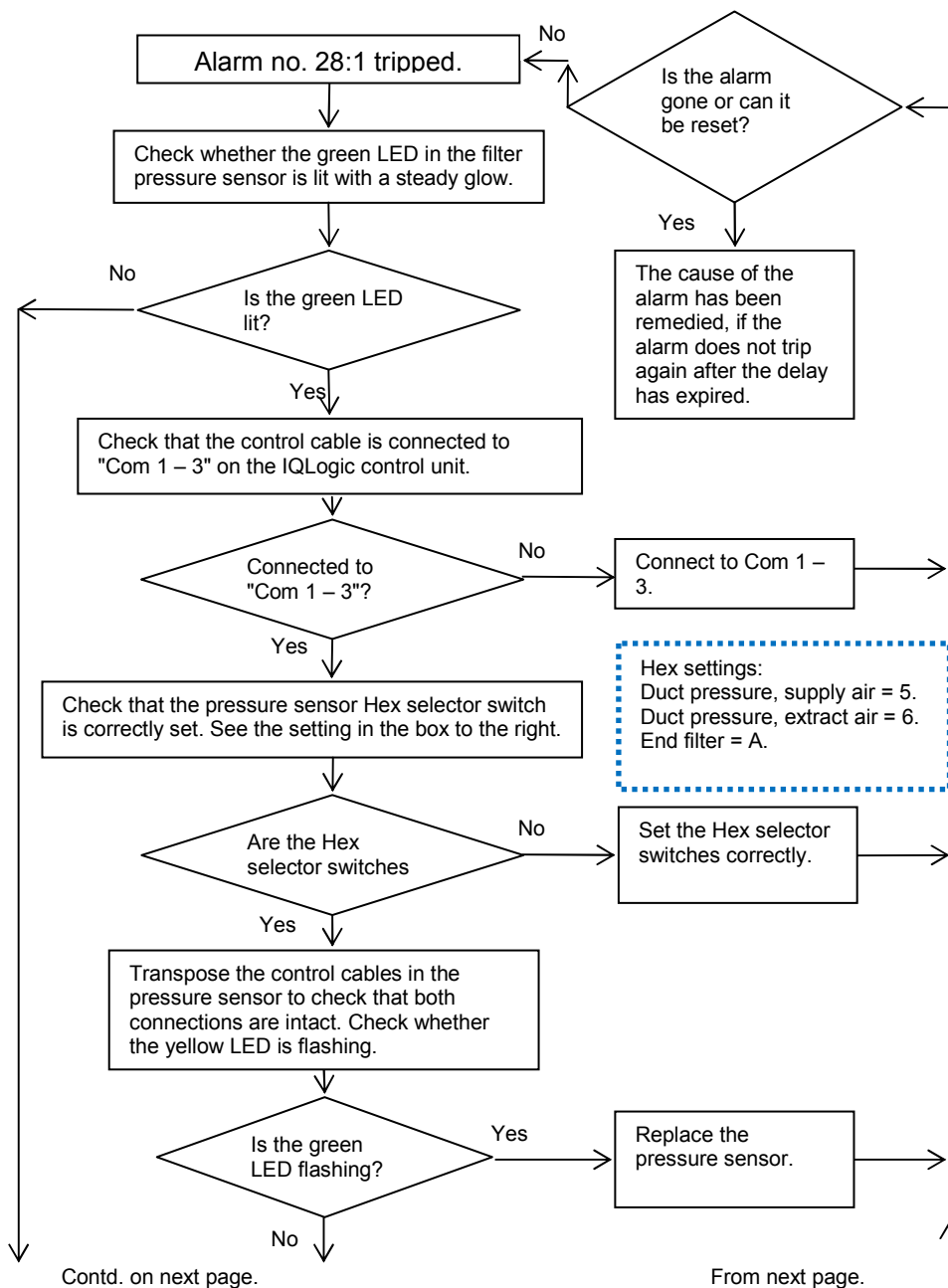

Fault tracing tripped alarm GOLD E			Document no.	Revision	Page 110 (146)
			Date released	Supersedes	
Type of document Instruktion	Drawn up by Bertil Sjunnesson	Revised by Magnus Hallén	Released and published by		

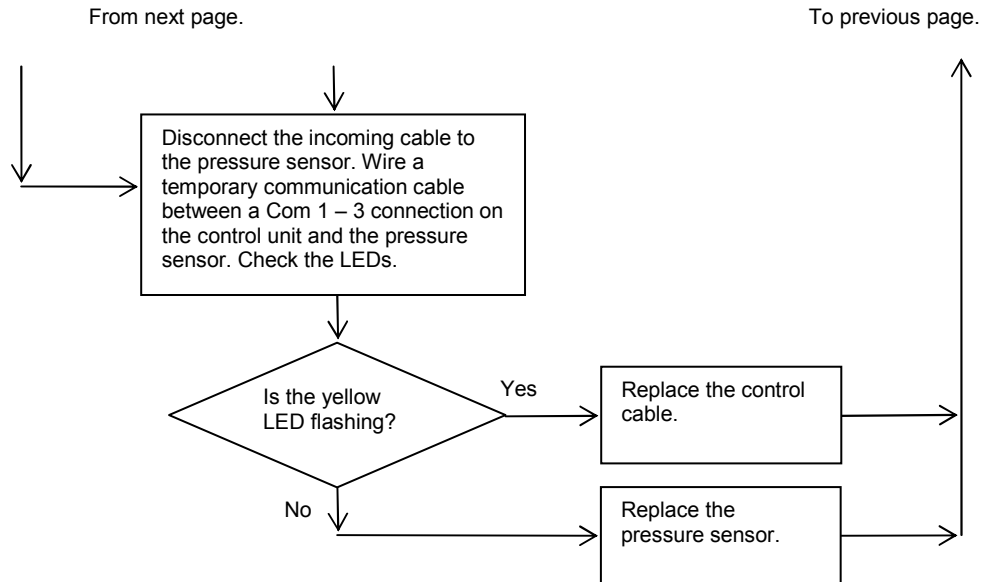

2.21.2. Alarm no. 28:2 "End filter, supply air, dirty"

The alarm is enabled when the End filter function is selected as active and the flow through the end filter is more than half the flow used for filter calibration.

The alarms trip when the pressure drop across the filter has been above the alarm limit for more than 10 minutes at a stretch.

For troubleshooting see Alarm no. 26:2 above.

2.22. Alarm group 30: FLOW MEASUREMENT

2.22.1. Alarm no. 30:1 "Flow measurement, supply air pressure sensor no. 1/2, communication error"

The alarm is always enabled for all GOLD units.

The alarm trips if the control unit does not achieve correct communication with the pressure sensor for the supply air flow.

The location of the fan inside the AHU determines the following address: Fan to the left = Address 1 and to the right = Address 2.

For troubleshooting see Alarm no. 17:2 above.

Fault tracing tripped alarm GOLD E			Document no.	Revision	Page
					111 (146)
			Date released	Supersedes	
Type of document	Drawn up by	Revised by	Released and published by		
Instruktion	Bertil Sjunnesson	Magnus Hallén			

2.22.2. Alarm no. 30:2 "Flow measurement, supply airflow below set point"

The alarm is enabled for all the GOLD units when under "Airflow", "Regulation mode" for "Supply air" is selected to "Airflow".

The alarms trip when the flow has been more than 10% below the relevant flow set point for more than 20 minutes at a stretch.

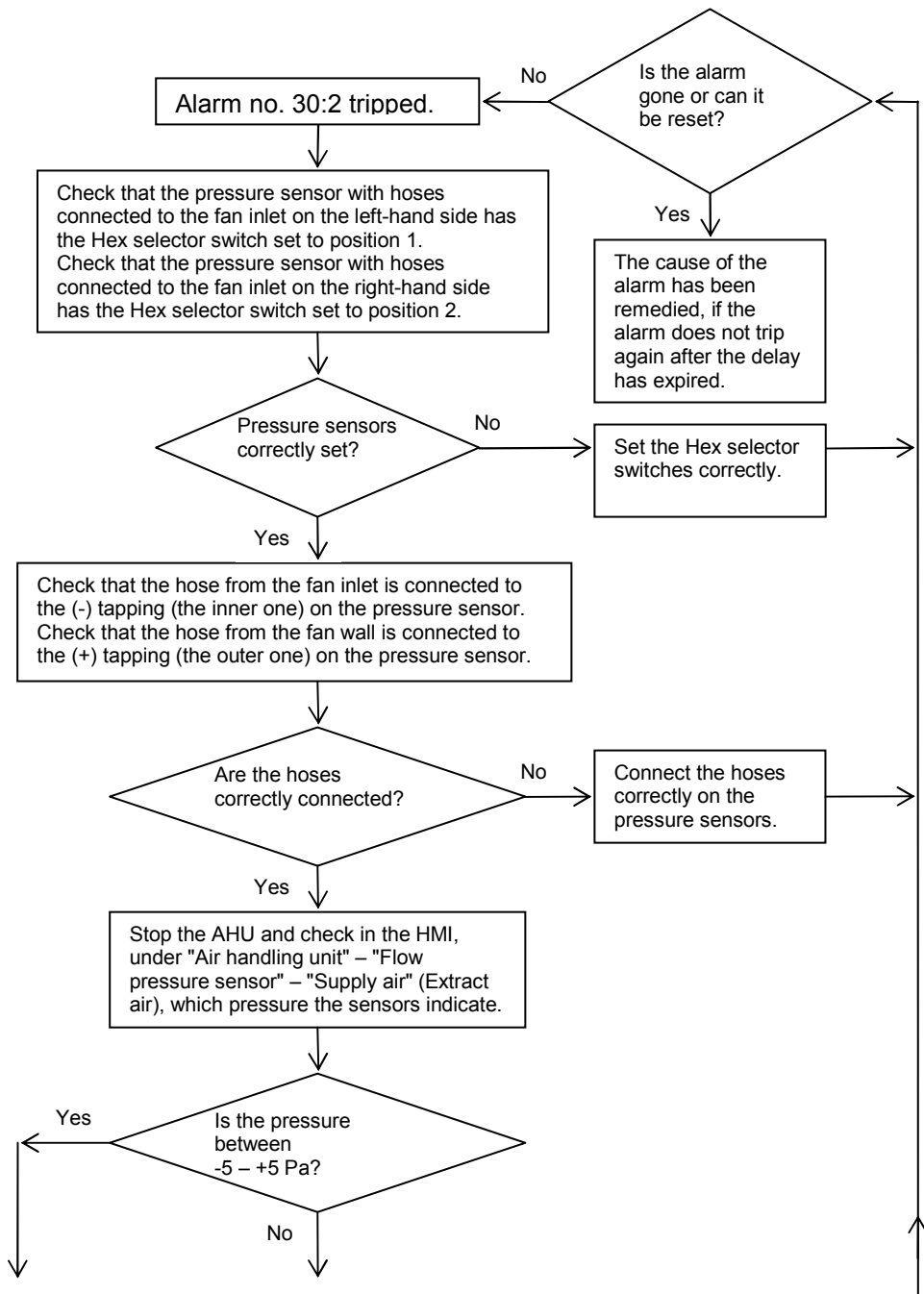

Contd. on next page.

From next page.

Fault tracing tripped alarm GOLD E			Document no.	Revision	Page
					112 (146)
			Date released	Supersedes	
Type of document	Drawn up by	Revised by	Released and published by		
Instruktion	Bertil Sjunnesson	Magnus Hallén			

From next page.

To previous page.

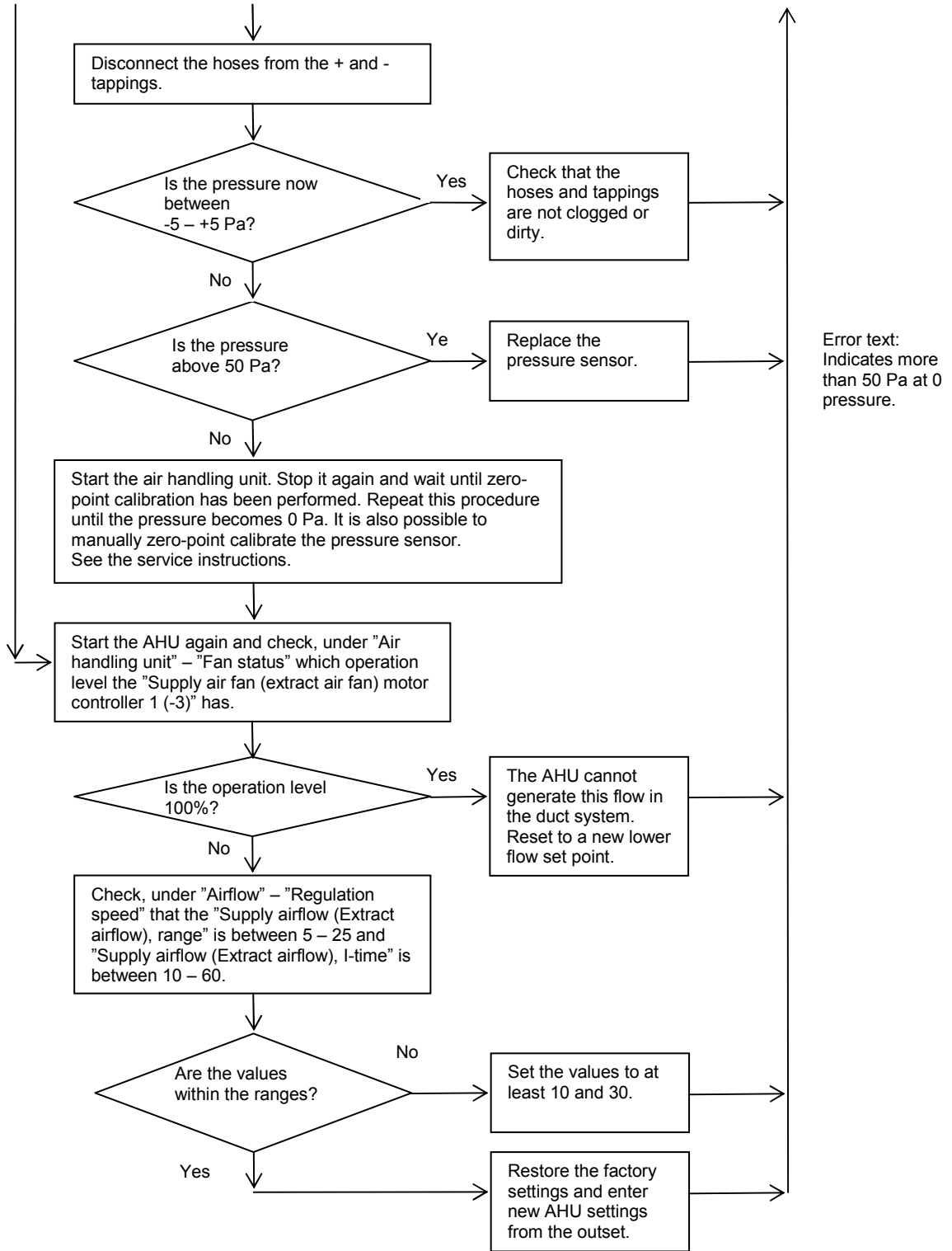

Fault tracing tripped alarm GOLD E			Document no.	Revision	Page
					113 (146)
			Date released	Supersedes	
Type of document	Drawn up by	Revised by	Released and published by		
Instruktion	Bertil Sjunnesson	Magnus Hallén			

2.22.3. Alarm no. 30:3 "Flow measurement, supply airflow above set point"

The alarm is enabled for all the GOLD units when under "Airflow", "Regulation mode" for "Supply air" is selected to "Airflow".

The alarms trip when the flow has been more than 10% above the relevant flow set point for more than 20 minutes at a stretch.

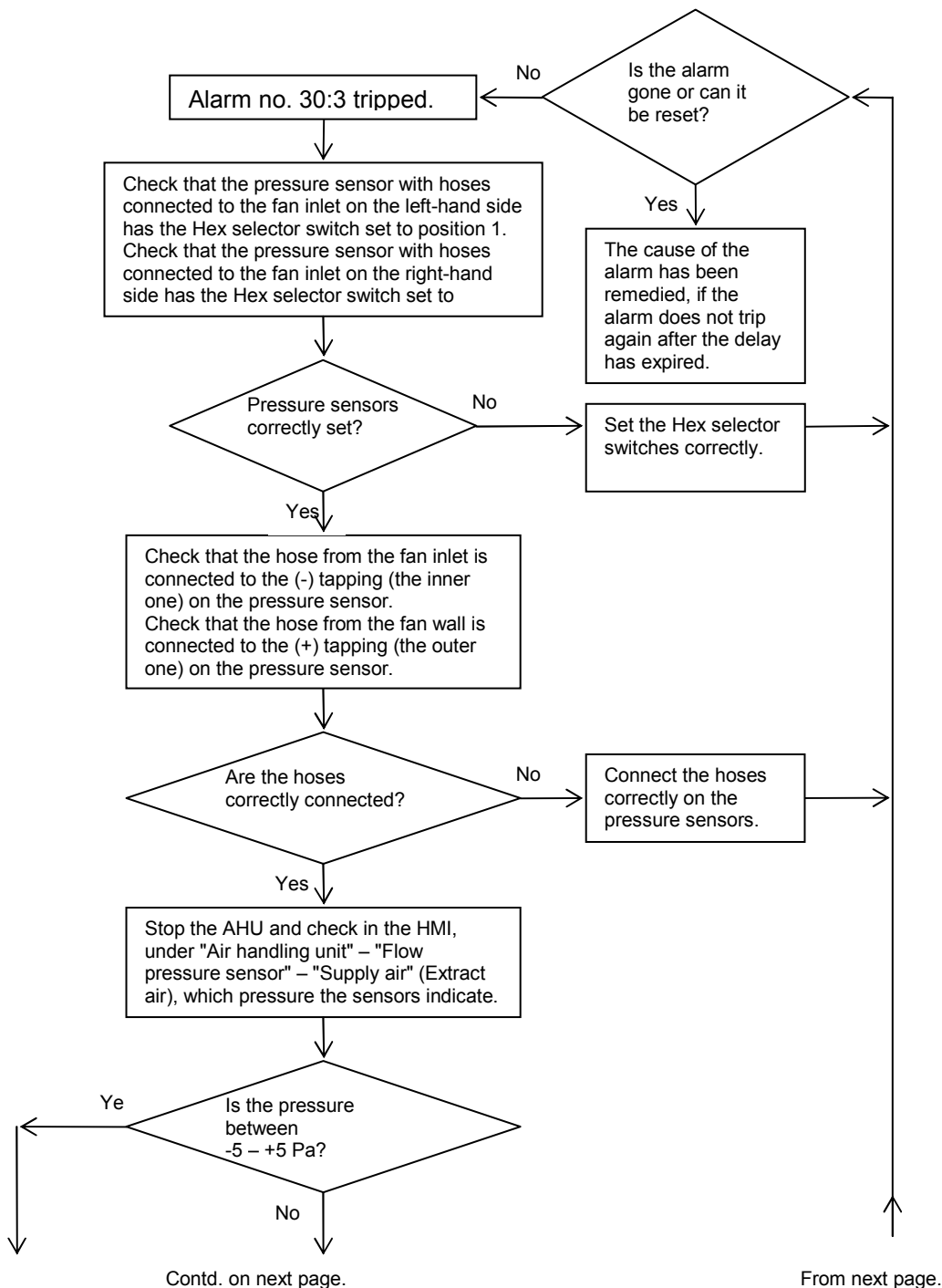

Fault tracing tripped alarm GOLD E			Document no.	Revision	Page
					114 (146)
			Date released	Supersedes	
Type of document	Drawn up by	Revised by	Released and published by		
Instruktion	Bertil Sjunnesson	Magnus Hallén			

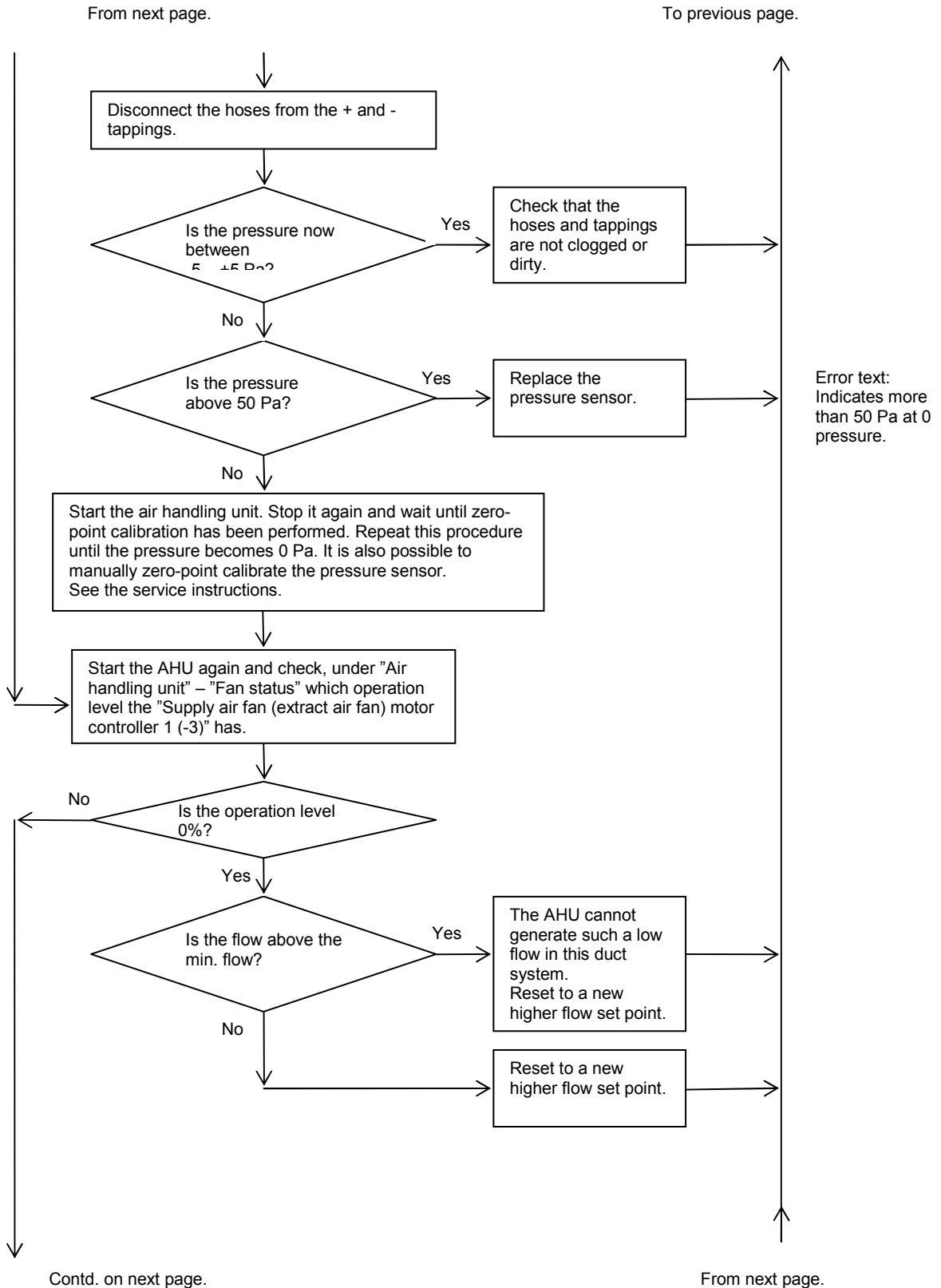

Fault tracing tripped alarm GOLD E			<i>Document no.</i>	<i>Revision</i>	<i>Page</i>
					115 (146)
			<i>Date released</i>	<i>Supersedes</i>	
<i>Type of document</i>	<i>Drawn up by</i>	<i>Revised by</i>	<i>Released and published by</i>		
Instruktion	Bertil Sjunnesson	Magnus Hallén			

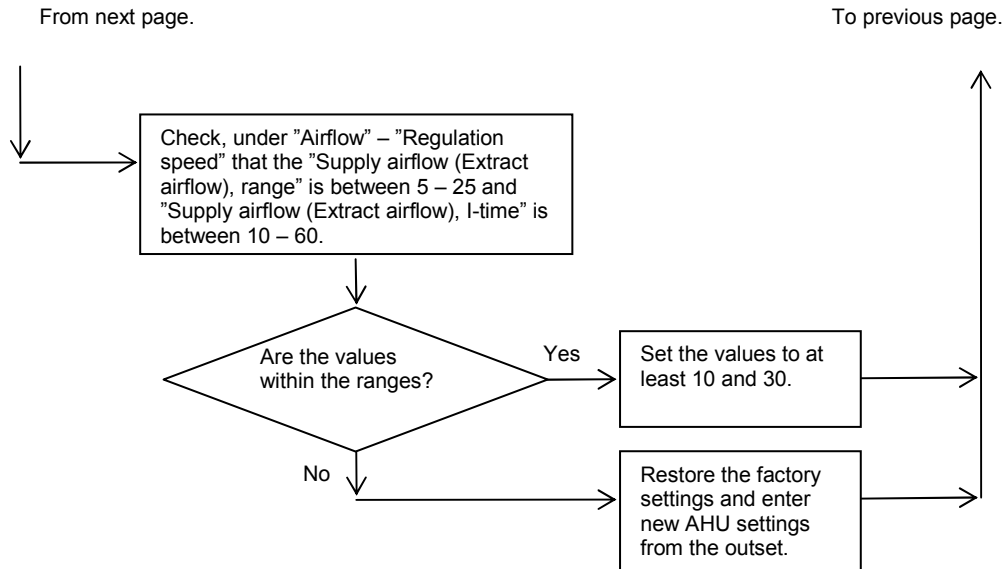

2.22.4. Alarm no. 30:6 "Flow measurement, extract air pressure sensor no. 1/2, communication error"

The alarm is always enabled for all GOLD units.

The alarm trips if the control unit does not achieve correct communication with the pressure sensor for the extract airflow.

The location of the fan inside the AHU determines the following address: Fan to the left = Address 1 and to the right = Address 2.

For troubleshooting see Alarm no. 17:2 above.

2.22.5. Alarm no. 30:7 "Flow measurement, extract airflow below set point"

The alarm is enabled for all the GOLD units when under "Airflow", "Regulation mode" for "Extract air" is selected to "Airflow".

The alarms trip when the flow has been more than 10% below the relevant flow set point for more than 20 minutes at a stretch.

For troubleshooting see Alarm no. 30:2 above.

2.22.6. Alarm no. 30:8 "Flow measurement, extract airflow above set point"

The alarm is enabled for all the GOLD units when under "Airflow", "Regulation mode" for "Extract air" is selected to "Airflow".

The alarms trip when the flow has been more than 10% above the relevant flow set point for more than 20 minutes at a stretch.

For troubleshooting see Alarm no. 30:3 above.

Fault tracing tripped alarm GOLD E			<i>Document no.</i>	<i>Revision</i>	<i>Page</i>
					116 (146)
			<i>Date released</i>	<i>Supersedes</i>	
<i>Type of document</i>	<i>Drawn up by</i>	<i>Revised by</i>	<i>Released and published by</i>		
Instruktion	Bertil Sjunnesson	Magnus Hallén			

2.22.7. Alarm no 30:11 "Flow measurement, carry over control, pressure sensor no. B communication error"

The alarm is always enabled for all GOLD units.

The alarm trips if the control unit does not achieve correct communication with the pressure sensor for "Carry over control".

Important! The pressure sensor must have pressure range: -1000Pa – +1000Pa. Part number 804937-01.

For troubleshooting see Alarm no. 30:1 above.

2.23. Alarm group 31: PRESSURE REGULATION

2.23.1. Alarm no. 31:1 "Pressure regulation, supply air pressure sensor no. 5 communication error".

The alarm is enabled for all the GOLD units when under "Airflow", "Regulation mode" for "Supply air" is selected to "Airflow".

The alarm trips if the control unit does not achieve correct communication with the pressure sensor for supply air duct pressure.

For troubleshooting see Alarm no. 28:1 above.

2.23.2. Alarm no. 31:2 "Pressure regulation, supply air pressure below set point"

The alarm is enabled for all the GOLD units when under "Airflow", "Regulation mode" for "Supply air" is selected to "Airflow".

The alarms trip when the duct pressure has been more than 10% below the relevant pressure set point for more than 20 minutes at a stretch.

Fault tracing tripped alarm GOLD E			Document no.	Revision	Page
					117 (146)
			Date released	Supersedes	
Type of document Instruktion	Drawn up by Bertil Sjunnesson	Revised by Magnus Hallén	Released and published by		

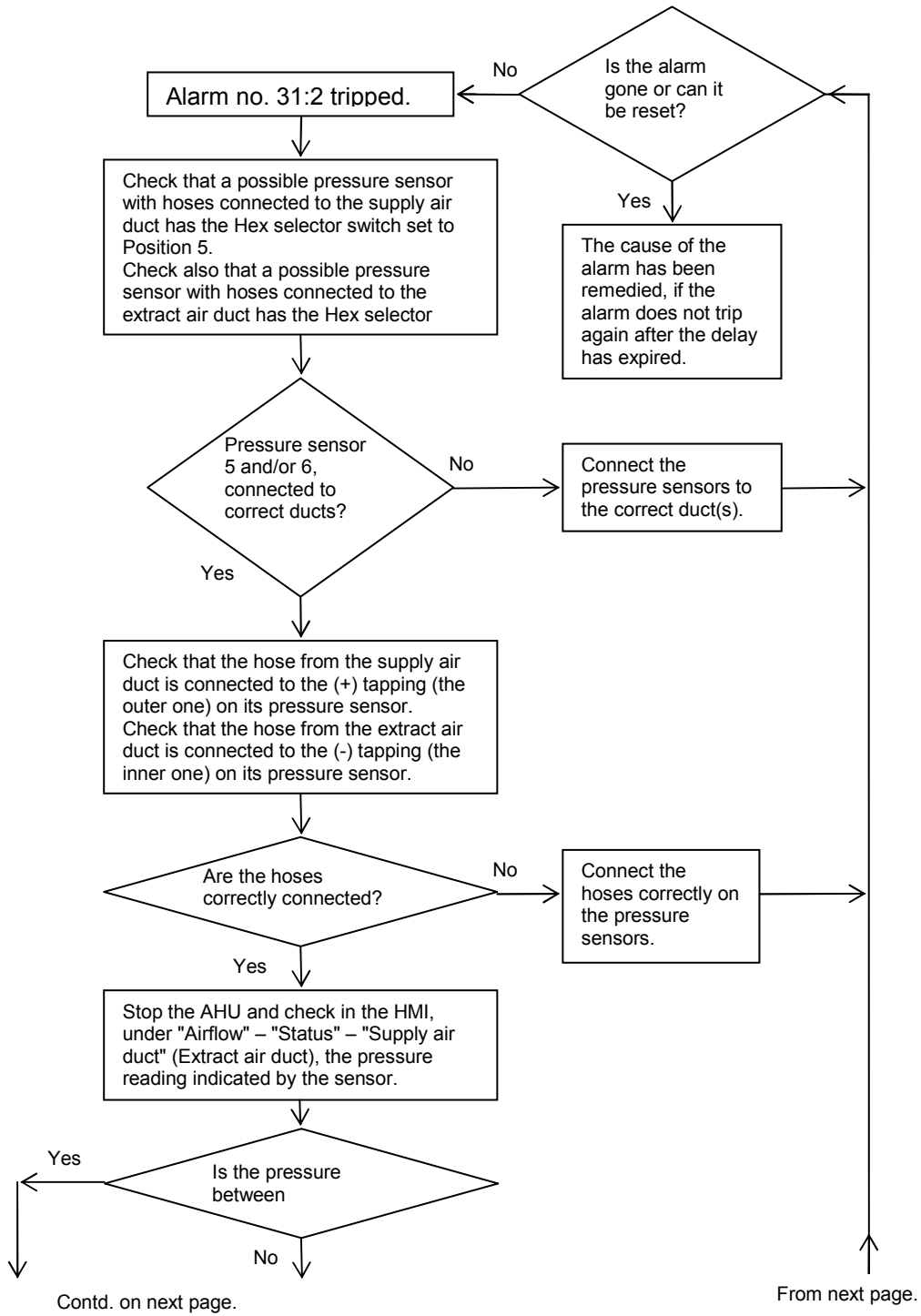

Fault tracing tripped alarm GOLD E			Document no.	Revision	Page
					118 (146)
			Date released	Supersedes	
Type of document Instruktion	Drawn up by Bertil Sjunnesson	Revised by Magnus Hallén	Released and published by		

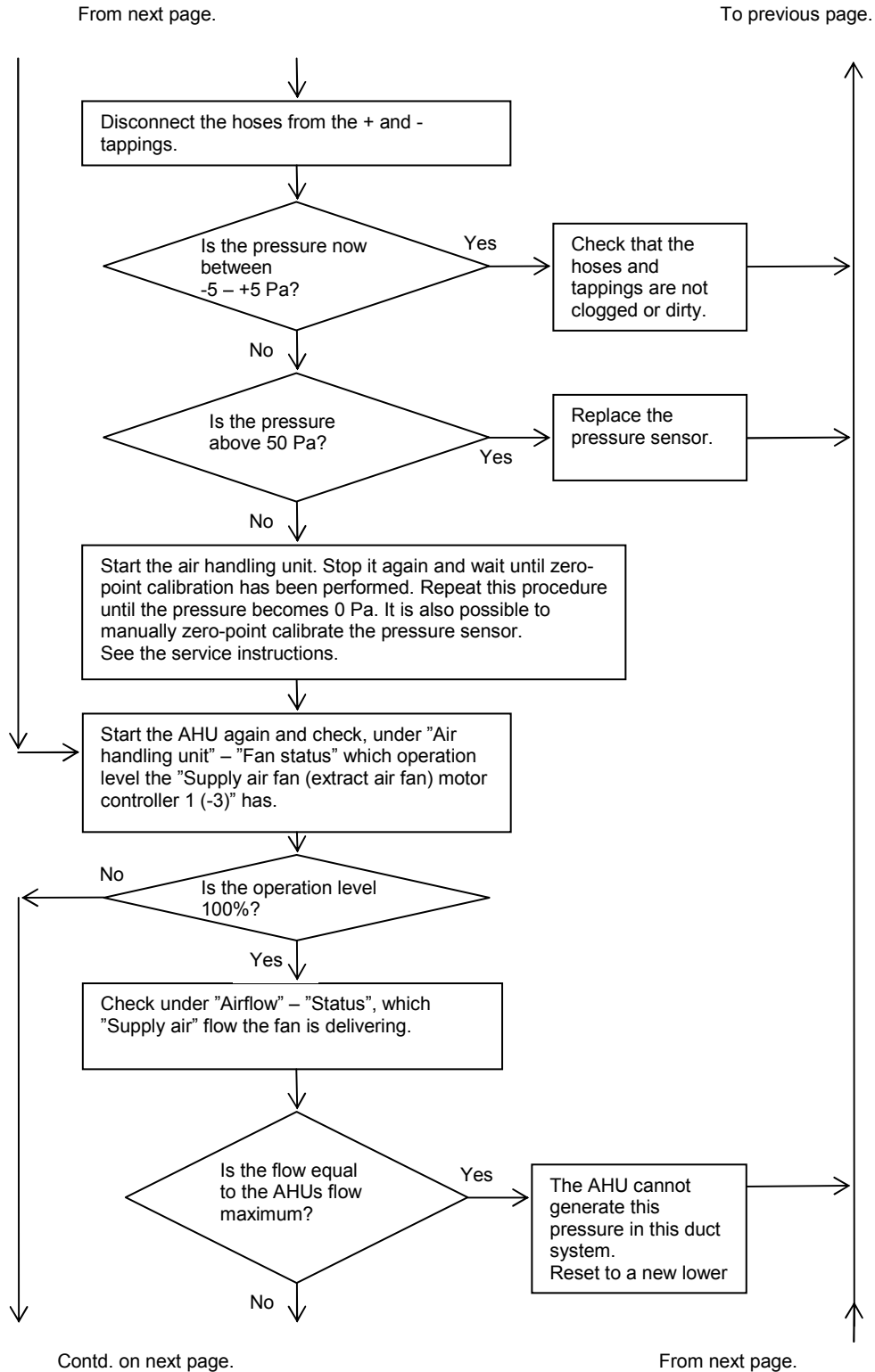

Fault tracing tripped alarm GOLD E			Document no.	Revision	Page
					119 (146)
			Date released	Supersedes	
Type of document	Drawn up by	Revised by	Released and published by		
Instruktion	Bertil Sjunnesson	Magnus Hallén			

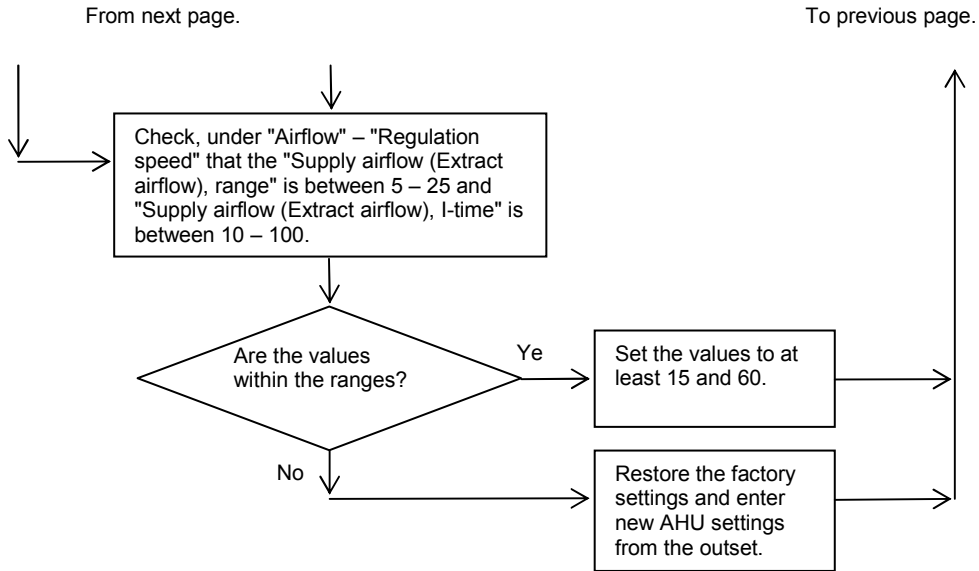

2.23.3. Alarm no. 31:3 "Pressure regulation, supply air pressure above set point"

The alarm is enabled for all the GOLD units when under "Airflow", "Regulation mode" for "Supply air" is selected to "Airflow".

The alarms trip when the duct pressure has been more than 10% above the relevant pressure set point for more than 20 minutes at a stretch.

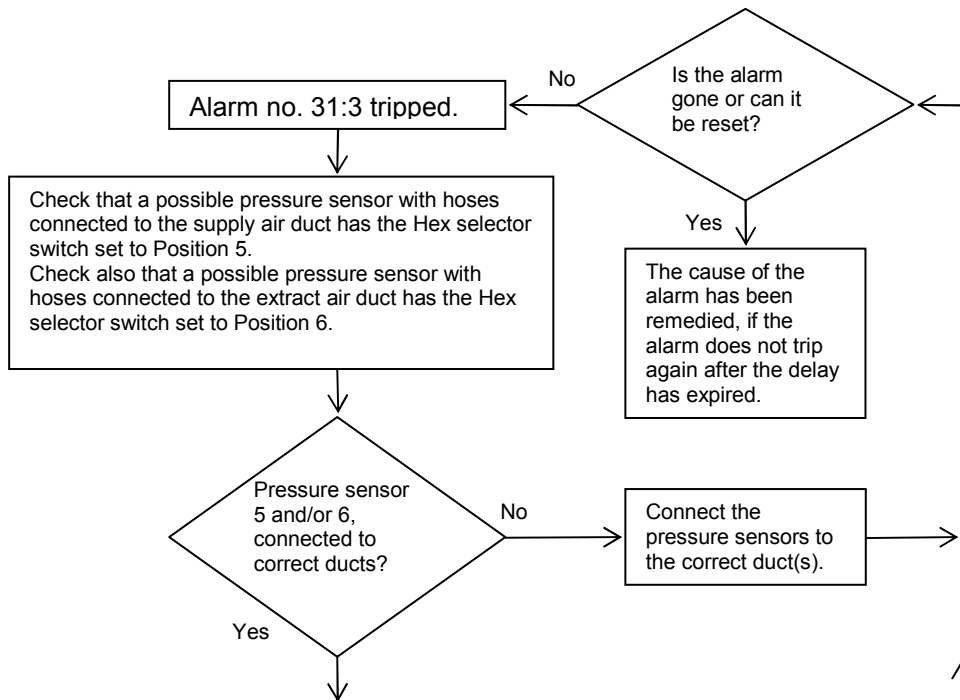

Contd. on next page.

From next page.

Fault tracing tripped alarm GOLD E			Document no.	Revision	Page
					120 (146)
			Date released	Supersedes	
Type of document Instruktion	Drawn up by Bertil Sjunnesson	Revised by Magnus Hallén	Released and published by		

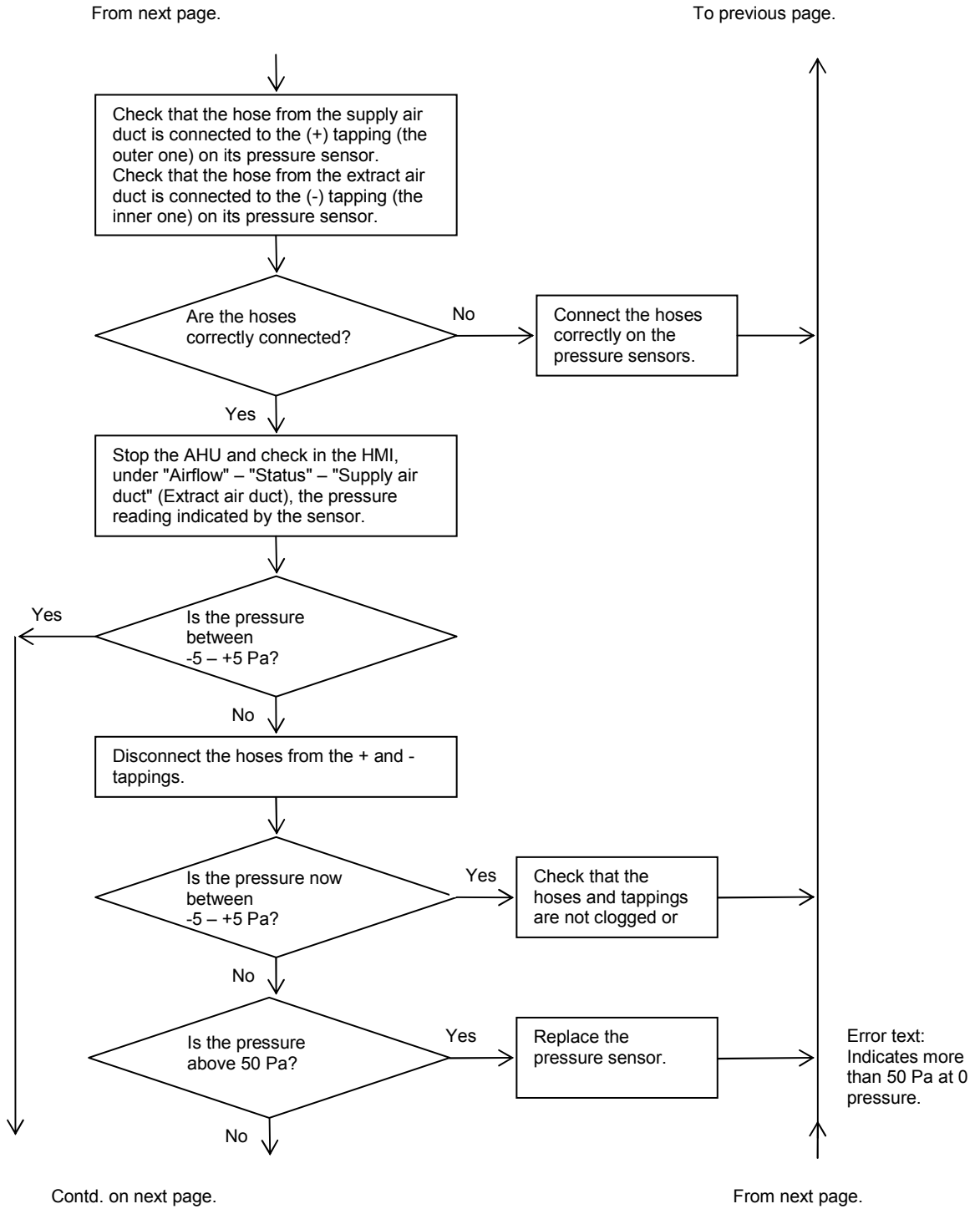

Fault tracing tripped alarm GOLD E			Document no.	Revision	Page
					121 (146)
			Date released	Supersedes	
Type of document	Drawn up by	Revised by	Released and published by		
Instruktion	Bertil Sjunnesson	Magnus Hallén			

From next page.

To previous page.

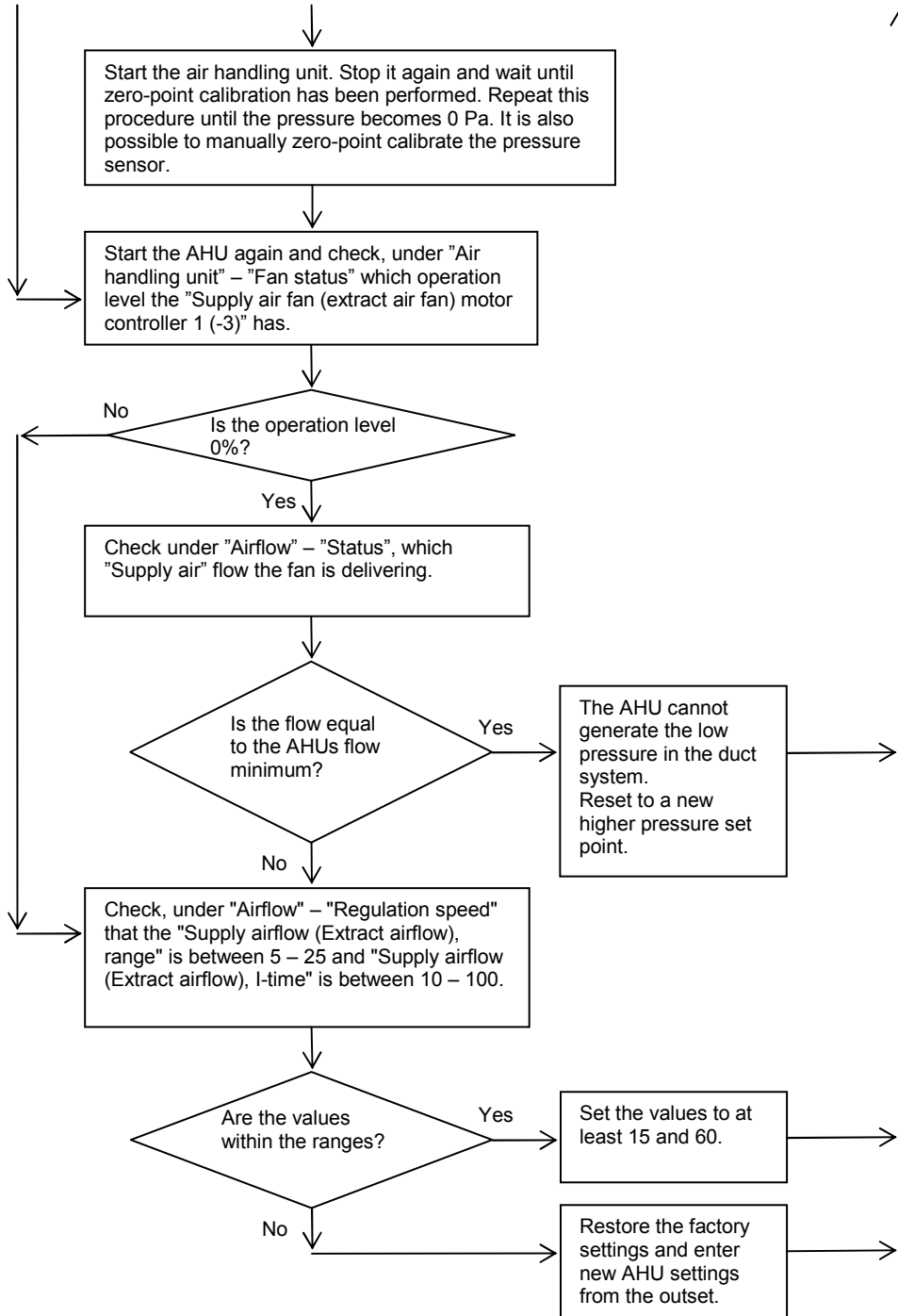

Fault tracing tripped alarm GOLD E			<i>Document no.</i>	<i>Revision</i>	<i>Page</i>
					122 (146)
			<i>Date released</i>	<i>Supersedes</i>	
<i>Type of document</i>	<i>Drawn up by</i>	<i>Revised by</i>	<i>Released and published by</i>		
Instruktion	Bertil Sjunnesson	Magnus Hallén			

2.23.4. Alarm no. 31:6 "Pressure regulation, extract air pressure sensor no. 6 communication error".

The alarm is enabled for all the GOLD units when under "Airflow", "Regulation mode" for "Extract air" is selected to "Duct pressure".

The alarm trips if the control unit does not achieve correct communication with the pressure sensor for extract air duct pressure.

For troubleshooting see Alarm no. 28:1 above.

2.23.5. Alarm no. 31:7 "Pressure regulation, extract air pressure below set point"

The alarm is enabled for all the GOLD units when under "Airflow", "Regulation mode" for "Extract air" is selected to "Duct pressure".

The alarms trip when the duct pressure has been more than 10% below the relevant pressure set point for more than 20 minutes at a stretch.

For troubleshooting see Alarm no. 31:2 above.

2.23.6. Alarm no. 31:8 "Pressure regulation, extract air pressure above set point"

The alarm is enabled for all the GOLD units when under "Airflow", "Regulation mode" for "Extract air" is selected to "Duct pressure".

The alarms trip when the duct pressure has been more than 10% above the relevant pressure set point for more than 20 minutes at a stretch.

For troubleshooting see Alarm no. 31:3 above.

2.24. Alarm group 32: ReCO2

2.24.1. Alarm no. 32:1 "ReCO2, I/O- module no. 0 communication error"

The alarm for IQLogic+ module 0 (S) is enabled when the ReCO2 function is activated.

The alarm trips if the control unit does not achieve correct communication with the module.

For troubleshooting see Alarm no. 15:1 above.

2.24.2. Alarm no. 32:2 "ReCO2, supply air pressure sensor no. 0 communication error".

The alarm is enabled when the ReCO2 function is activated.

The alarm trips if the control unit does not achieve correct communication with the ReCO2 pressure sensor.

For troubleshooting see Alarm no. 17:2 above.

Fault tracing tripped alarm GOLD E			<i>Document no.</i>	<i>Revision</i>	<i>Page</i>
					123 (146)
			<i>Date released</i>	<i>Supersedes</i>	
<i>Type of document</i>	<i>Drawn up by</i>	<i>Revised by</i>	<i>Released and published by</i>		
Instruktion	Bertil Sjunnesson	Magnus Hallén			

2.24.3. Alarm no. 32:3 "ReCO₂, recirculation damper monitoring tripped"

The alarms are enabled when the ReCO₂ function is activated.

The alarm trips when the feedback signal (input signal) from the recirculation damper motor does not agree with the control signal.

The alarm trips If the control signal is 0-2% and the feedback signal is > 8% and if the control signal is 97-100% and the feedback signal is < 92%.

For troubleshooting see Alarm no. 15:4 above.

2.24.4. Alarm no. 32:4 "ReCO₂, outdoor air damper monitoring tripped"

The alarms are enabled when the ReCO₂ function is activated.

The alarm trips when the feedback signal (input signal) from the outdoor air damper motor does not agree with the control signal.

The alarm trips If the control signal is 0-2% and the feedback signal is > 8% and if the control signal is 97-100% and the feedback signal is < 92%.

For troubleshooting see Alarm no. 15:4 above.

2.25. Alarm group 33: SERVICE

2.25.1. Alarm no. 33:1 "Service period over alarm limit"

The alarm is always enabled.

The alarm trips when the AHU has been operating longer than the preset "Service period".

Under "Alarm priority" – "Service period" set the required number of months until the next service visit.

Set the time as months. Remaining time to alarm, counts down to 0 months.

When the counter reaches 0 months, the alarm trips.

When resetting the alarm with "Reset", the alarm is delayed for 7 days before it returns.

To reset the alarm to the required time for a new service alarm, a new time (months) must be set under "Alarm priority" – "Service period".

2.25.2. Alarm no. 33:15 "Lock function tripped"

The alarm is enabled when the special function that blocks the AHUs operation has become activated.

The alarm trips when the preset time (date and time) has occurred.

To reset the alarm, you have to enter the code that you entered when you activated the lock function.

There is no "Master code".

Fault tracing tripped alarm GOLD E			<i>Document no.</i>	<i>Revision</i>	<i>Page</i>
					124 (146)
			<i>Date released</i>	<i>Supersedes</i>	
<i>Type of document</i>	<i>Drawn up by</i>	<i>Revised by</i>	<i>Released and published by</i>		
Instruktion	Bertil Sjunnesson	Magnus Hallén			

2.26. Alarm group 34: EXTERNAL CONTROLS

2.26.1. Alarm no. 34:1 "External control, I/O module no. 3 communication error"

The alarm is enabled for all the GOLD units when the "External operation, module 3" function is activated. The alarm trips if the control unit does not achieve correct communication with IQLogic+ module 3. The function can be activated in the HMI under "Inputs / Outputs" – "External operation, I/O module 3".

For troubleshooting see Alarm no. 3:1 above.

2.26.2. Alarm no. 34:2 "External control, I/O module no. 6 communication error"

The alarm is enabled for all the GOLD units when the "External operation, module 6" function is activated. The alarm trips if the control unit does not achieve correct communication with IQLogic+ module 6. The function can be activated in the HMI under "Inputs / Outputs" – "External operation, I/O module 6".

For troubleshooting see Alarm no. 3:1 above.

2.27. Alarm group 35: BOOSTER AIR TERMINALS

2.27.1. Alarm no. 35:1 "Booster air terminals, I/O module no. 8 communication error"

The alarm is enabled for all the GOLD units when the "Booster air terminals" function is activated. The alarm trips if the control unit does not achieve correct communication with IQLogic+ module 8. The function can be activated in the HMI under "Airflow" – "Booster air terminals".

For troubleshooting see Alarm no. 3:1 above.

2.28. Alarm groups 38 – 47: MIRU CONTROL NOS. 1 – 10

MIRU Control number 1 = Alarm group 38.

MIRU Control number 2 = Alarm group 39.

MIRU Control number 3 = Alarm group 40.

.....

MIRU Control number 10 = Alarm group 47.

Fault tracing tripped alarm GOLD E			Document no.	Revision	Page
					125 (146)
			Date released	Supersedes	
Type of document	Drawn up by	Revised by	Released and published by		
Instruktion	Bertil Sjunnesson	Magnus Hallén			

2.28.1. Alarm nos. 38:1 – 47:1 "MIRU Control nos. 1 – 10, communication error"

The alarms are enabled when the "MIRU Control" function is activated for corresponding MIRU Control 1 – 10. The alarm trips when the control unit does not achieve correct communication with the activated MIRU Control unit(s).

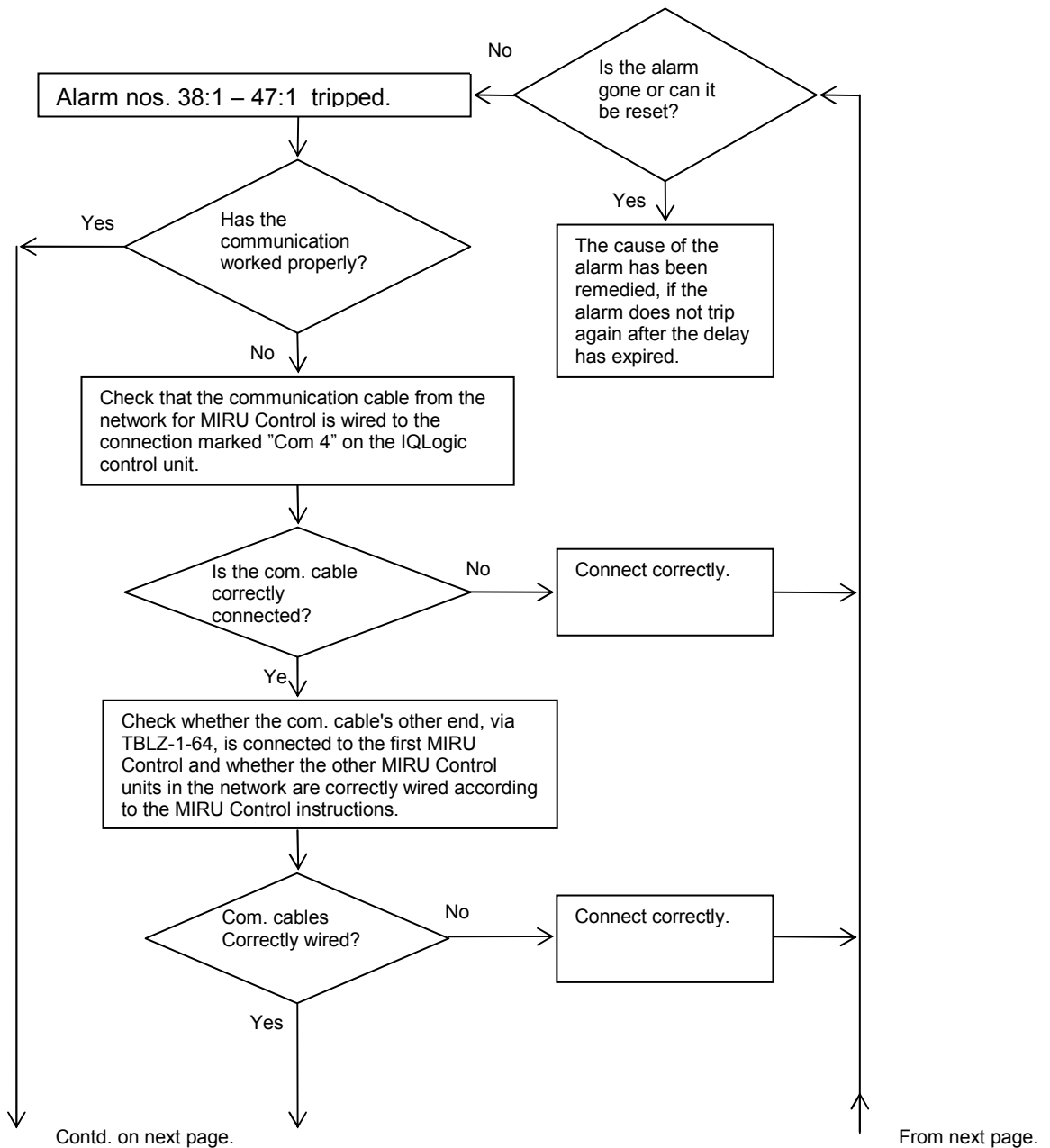

Fault tracing tripped alarm GOLD E			Document no.	Revision	Page
					126 (146)
			Date released	Supersedes	
Type of document	Drawn up by	Revised by	Released and published by		
Instruktion	Bertil Sjunnesson	Magnus Hallén			

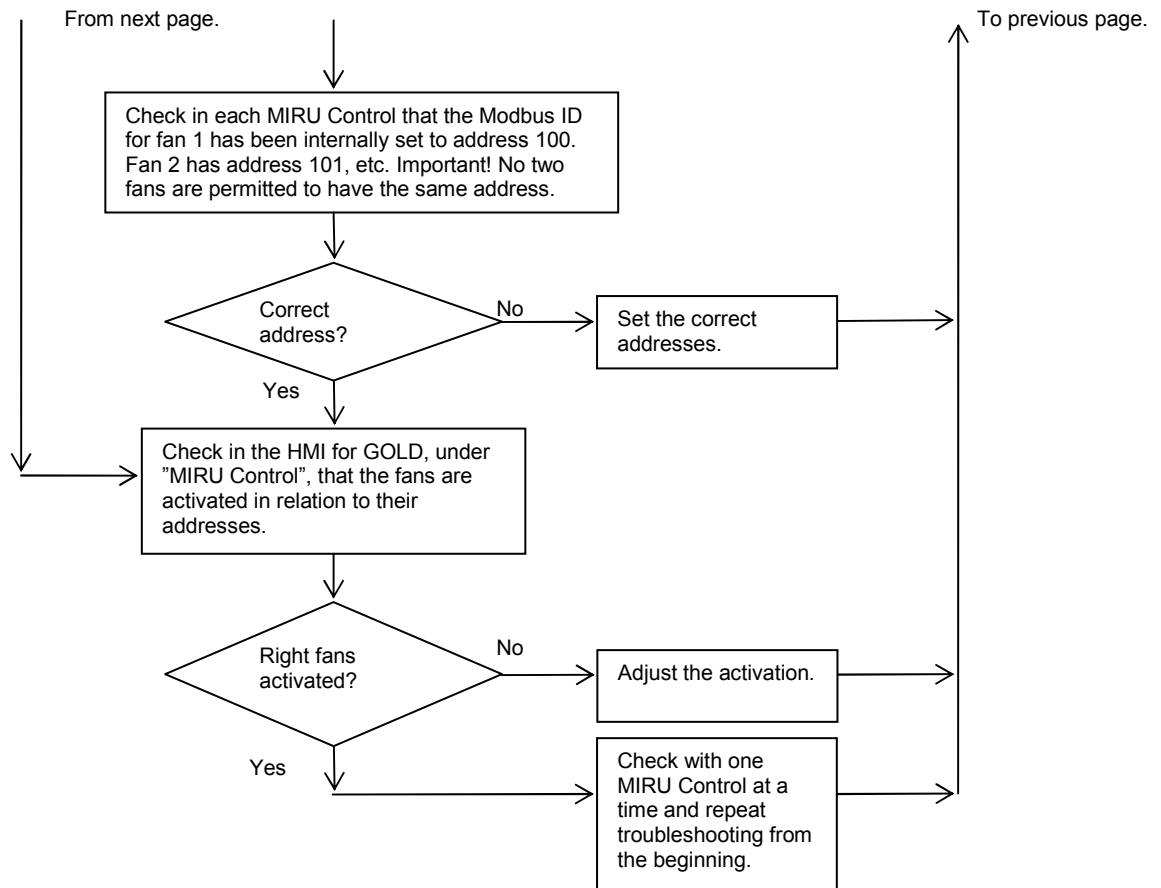

Fault tracing tripped alarm GOLD E			<i>Document no.</i>	<i>Revision</i>	<i>Page</i>
					127 (146)
			<i>Date released</i>	<i>Supersedes</i>	
<i>Type of document</i>	<i>Drawn up by</i>	<i>Revised by</i>	<i>Released and published by</i>		
Instruktion	Bertil Sjunnesson	Magnus Hallén			

2.28.2. Alarm nos. 38.2 – 47:2 "MIRU Control nos. 1 – 10, fan motor controller tripped"

The alarms are enabled when the "MIRU Control" function is activated for corresponding MIRU Control, 1 – 10. The alarm trips when the MIRUVENT fan transmits a common fault alarm to its MIRU Control.

Check in the display on the relevant MIRU Control and reset the alarm locally.
Troubleshoot in the MIRUVENT fan.

2.28.3. Alarm nos. 38.3 – 47:3 "MIRU Control nos. 1 – 10, motor controller communication error"

The alarms are enabled when the "MIRU Control" function is activated for corresponding MIRU Control, 1 – 10. The alarm trips when the corresponding MIRU Control does not obtain correct communication with its MIRUVENT fan.

Check in the display on the relevant MIRU Control and reset the alarm locally.
Troubleshoot in the MIRU Control and check the MIRUVENT fan and the communication between them.

2.28.4. Alarm nos. 38.4 – 47:4 "MIRU Control nos. 1 – 10, flow pressure sensor no. 0 com. error"

The alarms are enabled when the "MIRU Control" function is activated for corresponding MIRU Control, 1 – 10. The alarm trips when the corresponding MIRU Control does not obtain correct communication with its pressure sensor for flow measurement in the MIRUVENT fan.

Check in the display on the relevant MIRU Control whether the settings are correct.
Is there a pressure sensor with Hex address 0 and should flow measurement be activated?

Troubleshoot in the MIRU Control and check the communication to the pressure sensor.
Should be connected to connection X10 or X11 in the MIRU Control.

2.28.5. Alarm nos. 38.5 – 47:5 "MIRU Control nos. 1 – 10, duct pressure sensor no. 1 com. error"

The alarms are enabled when the "MIRU Control" function is activated for corresponding MIRU Control, 1 – 10. The alarm trips when the corresponding MIRU Control does not obtain correct communication with its pressure sensor for duct pressure in the MIRUVENT fan.

Check in the display on the relevant MIRU Control whether the settings are correct.
Is there a pressure sensor with Hex address 1 and should duct pressure regulation be activated?

Troubleshoot in the MIRU Control and check the communication to the pressure sensor.
Should be connected to connection X10 or X11 in the MIRU Control.

2.28.6. Alarm nos. 38.6 – 47:6 "MIRU Control nos. 1 – 10, temperature sensor defective"

The alarms are enabled when the "MIRU Control" function is activated for corresponding MIRU Control, 1 – 10. The alarm trips when the corresponding MIRU Control does not obtain correct communication with its temperature sensor for outdoor temperature compensation.

Fault tracing tripped alarm GOLD E			<i>Document no.</i>	<i>Revision</i>	<i>Page</i>
					128 (146)
			<i>Date released</i>	<i>Supersedes</i>	
<i>Type of document</i>	<i>Drawn up by</i>	<i>Revised by</i>	<i>Released and published by</i>		
Instruktion	Bertil Sjunnesson	Magnus Hallén			

Check in the display on the relevant MIRU Control whether the settings are correct.
Is a temperature sensor connected to Terminal 20 (-) and Terminal 21 (s) and should outdoor compensation be activated?

Troubleshoot in the MIRU Control and check the how the pressure sensor is wired.

2.28.7. Alarm nos. 38.7 – 47:7 "MIRU Control nos. 1 – 10, flow/pressure deviates from set point"

The alarms are enabled when the "MIRU Control" function is activated for corresponding MIRU Control, 1 – 10. The alarm trips when the corresponding MIRU Control has a flow/duct pressure that continuously deviates from its set point.

Check in the display on the relevant MIRU Control whether the settings are correct.
Check that the hoses to the pressure sensors are correctly connected.

Troubleshoot in the MIRU Control and check the current flow or duct pressure.

Fault tracing tripped alarm GOLD E			Document no.	Revision	Page
					129 (146)
			Date released	Supersedes	
Type of document Instruktion	Drawn up by Bertil Sjunnesson	Revised by Magnus Hallén	Released and published by		

2.29. Alarm groups 49 – 51: SUPPLY AIR FAN nos. 1A, 2A and 3A.

The fans are numbered 1,2 and 3 starting from inspection door.

2.29.1. Alarm nos. 49.1 – 51:1 "Supply air fan nos. 1A – 3A, communication error"

The size of air handling unit determines which alarms are enabled. GOLD 04-40 have one supply air fan (1A). GOLD 50-80 GOLD have two supply air fans (1A – 2A). GOLD 100-120 with up to 6.5 kW motors have 3 supply air fans (1A – 3A).

The alarms trip when the IQLogic control unit does not have communication with the corresponding motor controller.

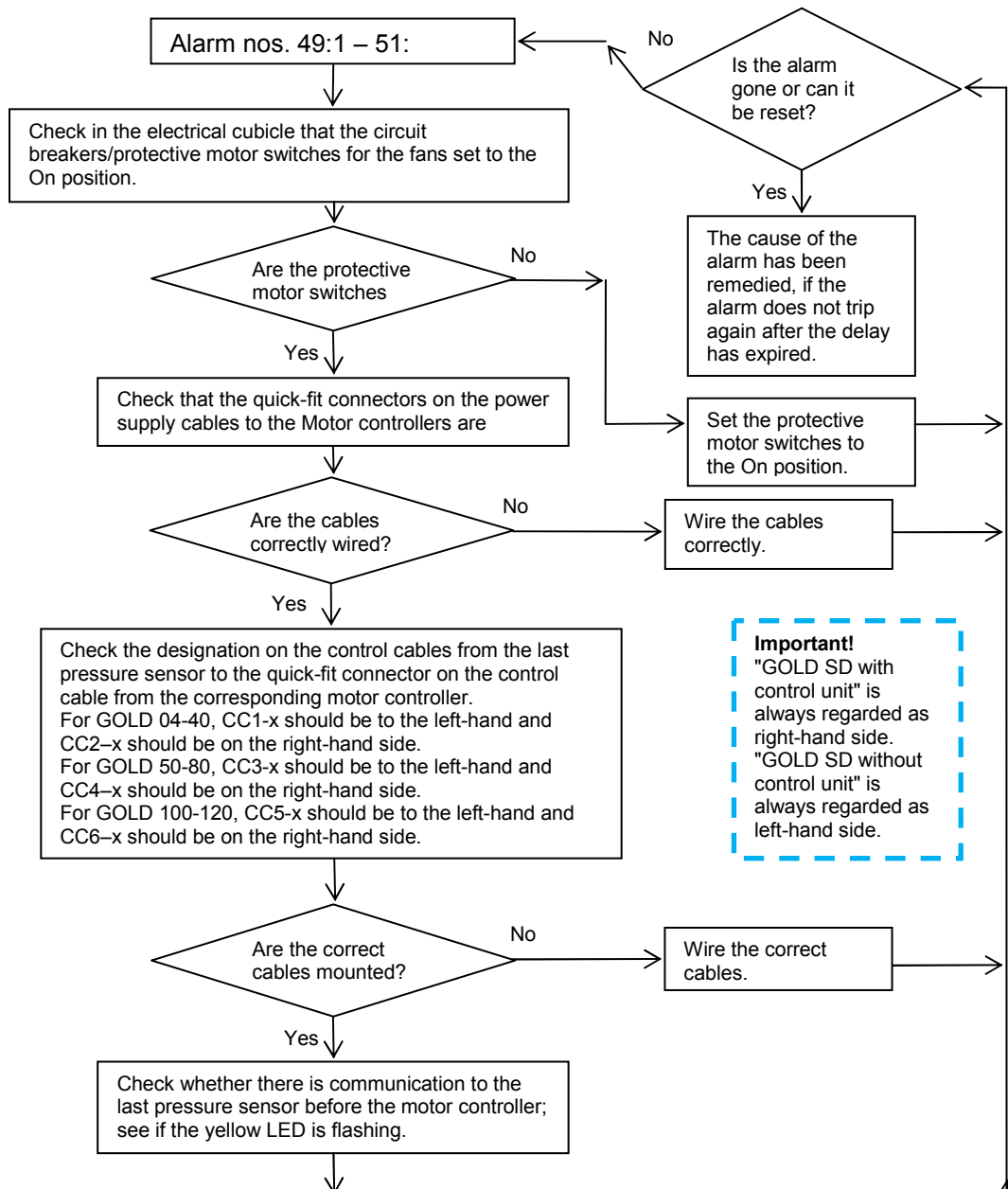

Important!
"GOLD SD with control unit" is always regarded as right-hand side.
"GOLD SD without control unit" is always regarded as left-hand side.

Fault tracing tripped alarm GOLD E			Document no.	Revision	Page
					130 (146)
			Date released	Supersedes	
Type of document	Drawn up by	Revised by	Released and published by		
Instruktion	Bertil Sjunnesson	Magnus Hallén			

From next page.

To previous page.

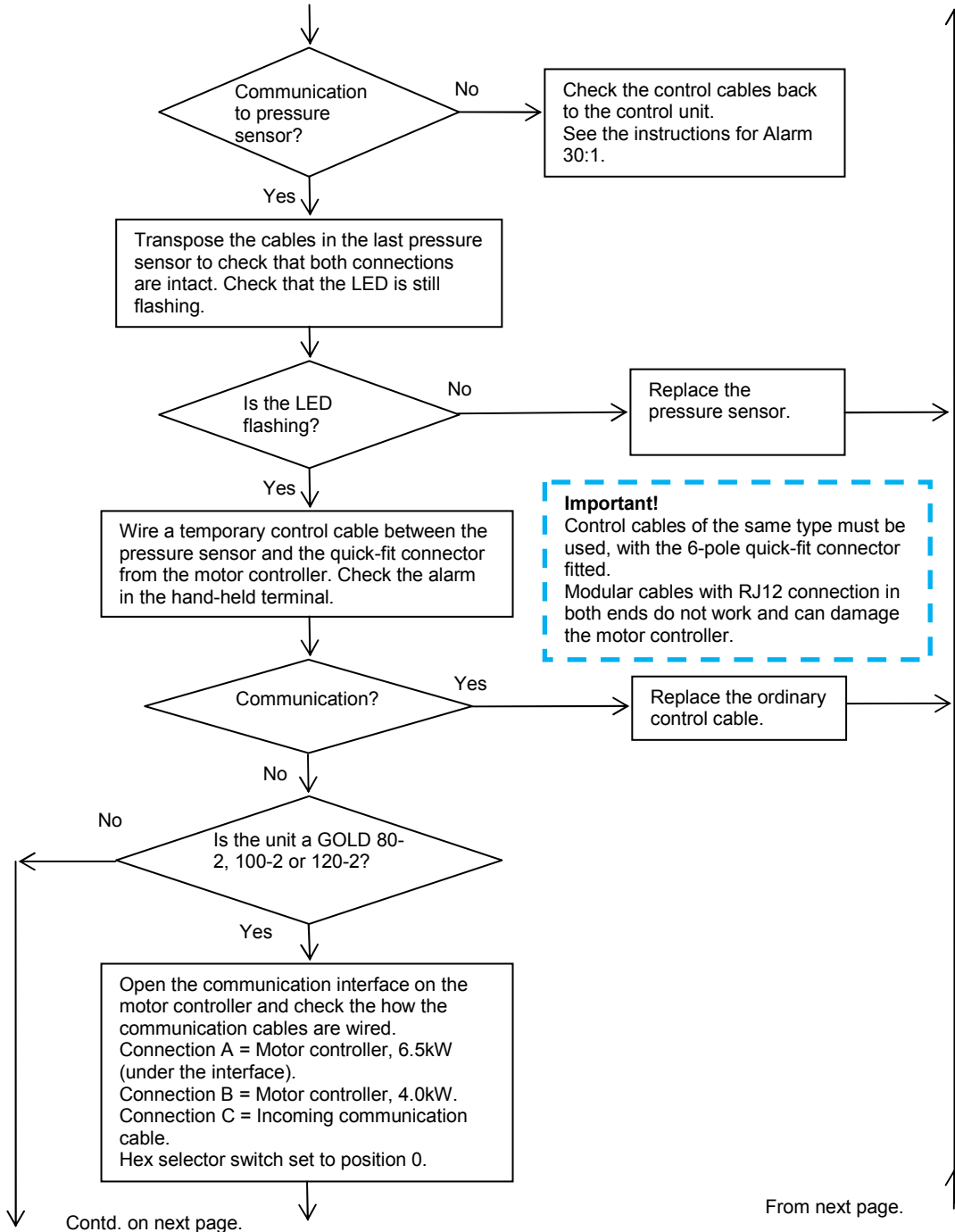

Fault tracing tripped alarm GOLD E			Document no.	Revision	Page
					131 (146)
			Date released	Supersedes	
Type of document Instruktion	Drawn up by Bertil Sjunnesson	Revised by Magnus Hallén	Released and published by		

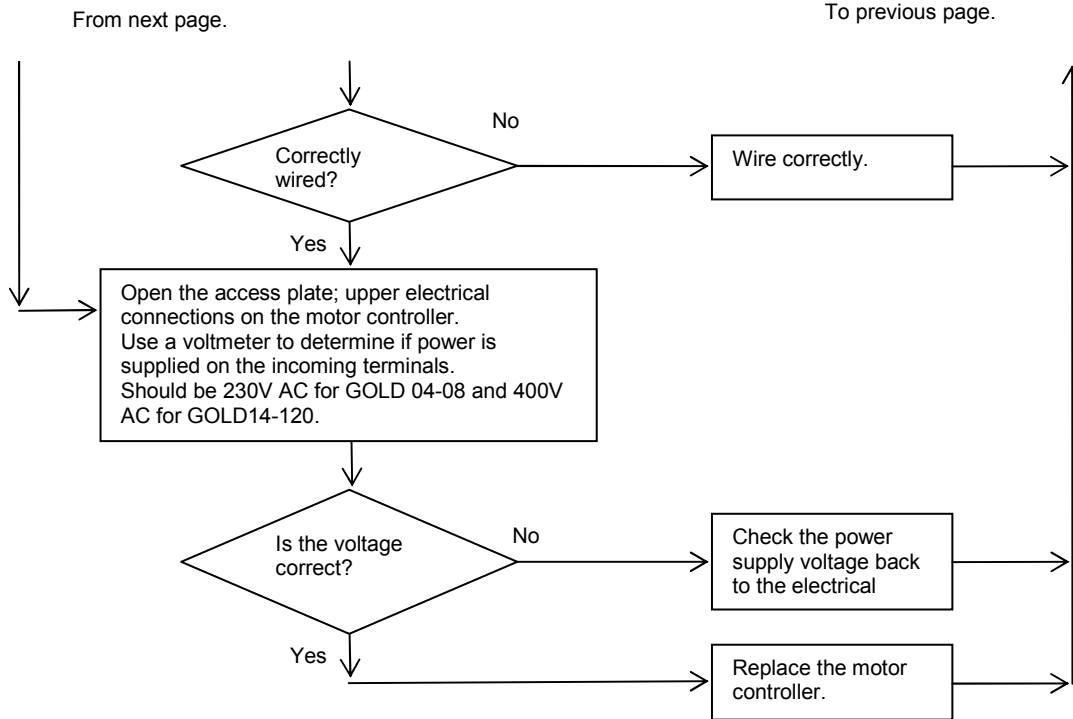

Fault tracing tripped alarm GOLD E			Document no.	Revision	Page
					132 (146)
			Date released	Supersedes	
Type of document Instruktion	Drawn up by Bertil Sjunnesson	Revised by Magnus Hallén	Released and published by		

2.29.2. Alarm nos. 49.2 – 51:2 "Supply air fan nos. 1A – 3A over current"

The size of air handling unit determines which alarms are enabled. GOLD 04-40 have one supply air fan (1A). GOLD 50-80 GOLD have two supply air fans (1A – 2A). GOLD 100-120 with up to 6.5 kW motors have 3 supply air fans (1A – 3A).

The alarms trip when the internal monitoring function in the EC motor controller detects current supplied to the motor above the alarm limit.

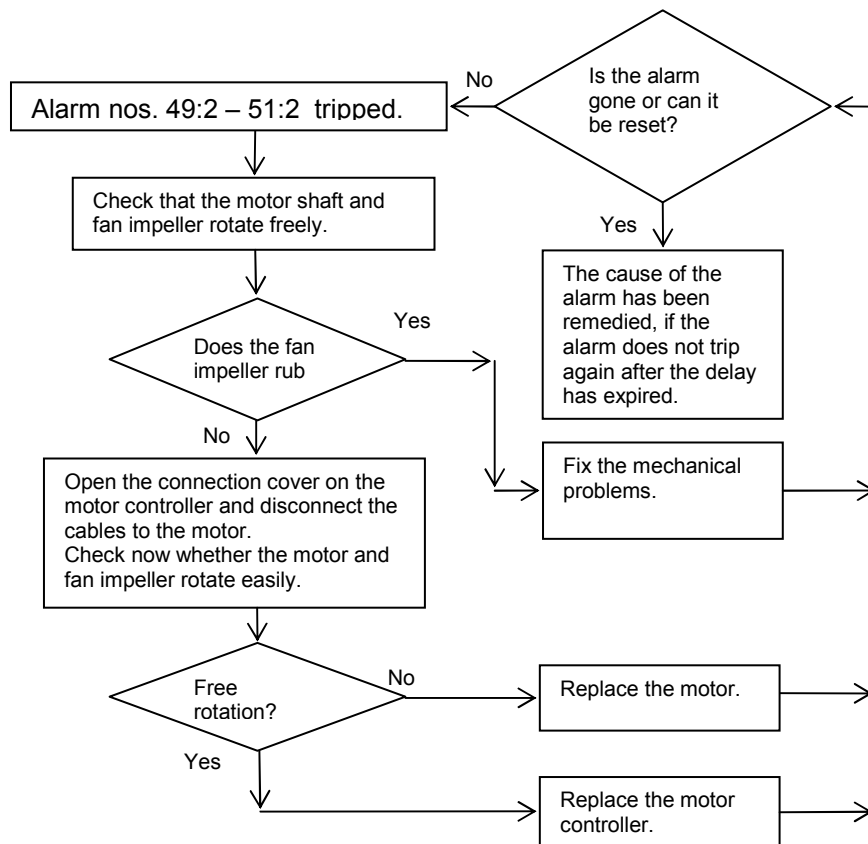

Fault tracing tripped alarm GOLD E			Document no.	Revision	Page
					133 (146)
Date released		Supersedes			
Type of document	Drawn up by	Revised by	Released and published by		
Instruktion	Bertil Sjunnesson	Magnus Hallén			

2.29.3. Alarm nos. 49.3 – 51:3 "Supply air fan nos. 1A – 3A under voltage"

The size of air handling unit determines which alarms are enabled. GOLD 04-40 have one supply air fan (1A). GOLD 50-80 GOLD have two supply air fans (1A – 2A). GOLD 100-120 with up to 6.5 kW motors have 3 supply air fans (1A – 3A).

The alarms trip when the internal monitoring function in the EC motor controller detects voltage below the alarm limit.

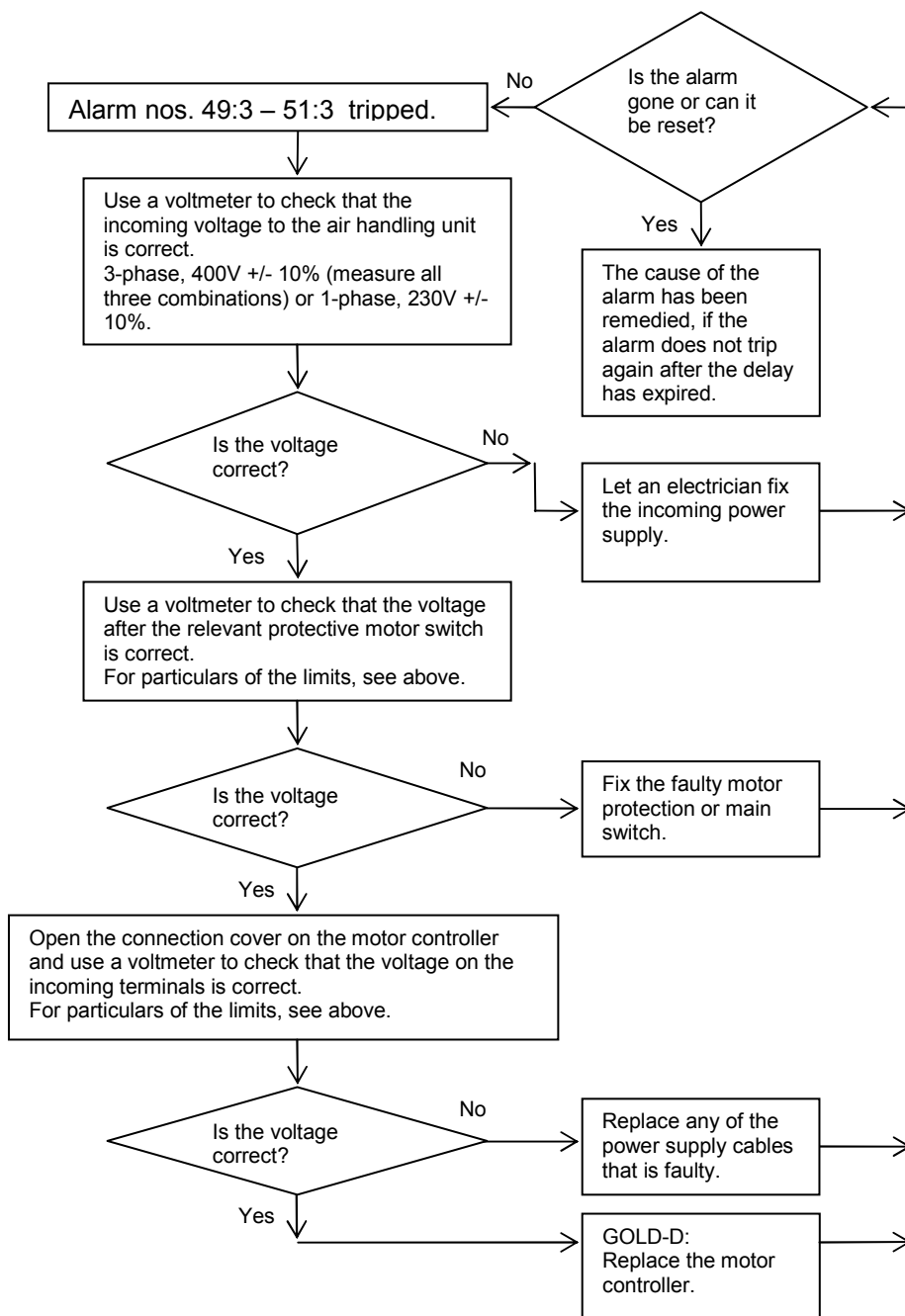

Fault tracing tripped alarm GOLD E			Document no.	Revision	Page
					134 (146)
			Date released	Supersedes	
Type of document	Drawn up by	Revised by	Released and published by		
Instruktion	Bertil Sjunnesson	Magnus Hallén			

2.29.4. Alarm nos. 49.4 – 51:4 "Supply air fan nos. 1A – 3A over voltage"

The size of air handling unit determines which alarms are enabled. GOLD 04-40 have one supply air fan (1A). GOLD 50-80 GOLD have two supply air fans (1A – 2A). GOLD 100-120 with up to 6.5 kW motors have 3 supply air fans (1A – 3A).

The alarms trip when the internal monitoring function in the EC motor controller detects internal voltage above the alarm limit.

The alarm can occur when incoming power supply voltage exceeds the AHU's specified limit values. 3-phase, 400V +10% or 1-phase, 230 +10%.

The alarm can also occur when the motor that rotates too fast (generator effect) because some other fan is discharging air across the AHU's fan.

Use a voltmeter to check the incoming voltage.

Also check whether the fans rotate due to external airflow when the AHU is stopped.

2.29.5. Alarm nos. 49.5 – 51:5 "Supply air fan nos. 1A – 3A over temperature"

The size of air handling unit determines which alarms are enabled. GOLD 04-40 have one supply air fan (1A). GOLD 50-80 GOLD have two supply air fans (1A – 2A). GOLD 100-120 with up to 6.5 kW motors have 3 supply air fans (1A – 3A).

The alarms trip when the internal monitoring function in the EC motor controller detects an internal temperature above the alarm limit of 90°C.

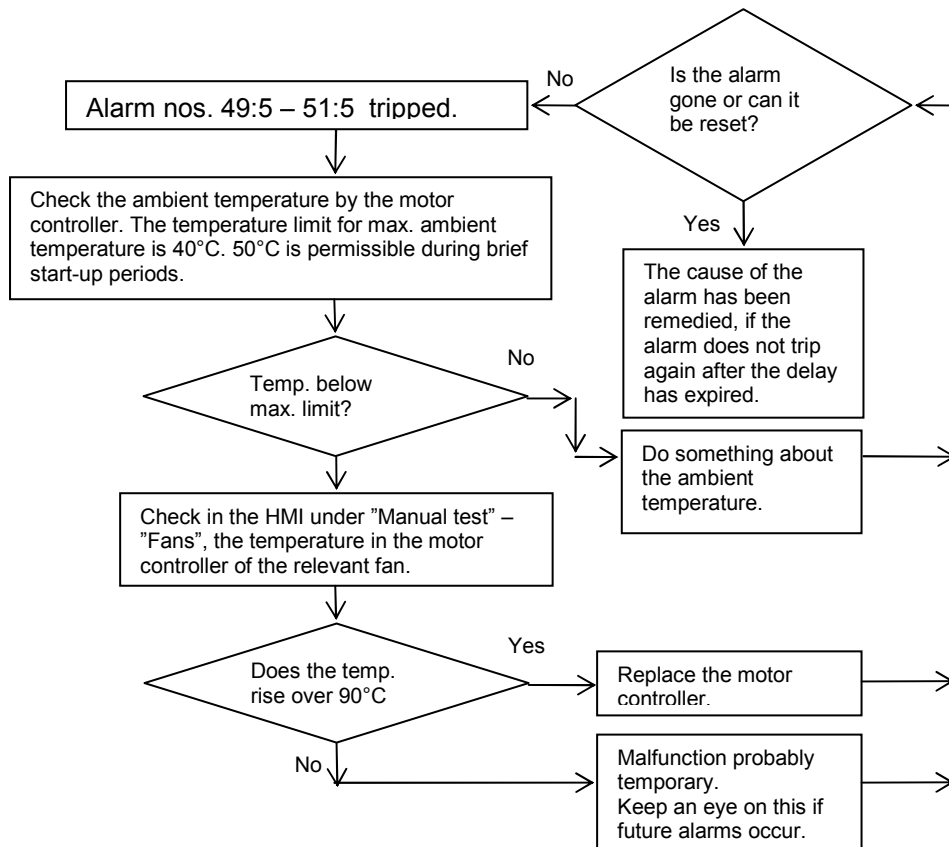

Fault tracing tripped alarm GOLD E			<i>Document no.</i>	<i>Revision</i>	<i>Page</i>
					135 (146)
			<i>Date released</i>	<i>Supersedes</i>	
<i>Type of document</i>	<i>Drawn up by</i>	<i>Revised by</i>	<i>Released and published by</i>		
Instruktion	Bertil Sjunnesson	Magnus Hallén			

2.29.6. Alarm nos. 49.6 – 51:6 "Supply air fan nos. 1A – 3A fan motor blocked"

The size of air handling unit determines which alarms are enabled. GOLD 04-40 have one supply air fan (1A). GOLD 50-80 GOLD have two supply air fans (1A – 2A). GOLD 100-120 with up to 6.5 kW motors have 3 supply air fans (1A – 3A).

The alarms trip when the internal monitoring function in the motor controller indicates that the motor is blocked or operates too sluggishly when it is to start up.

Rotate the fan impeller by hand to check that the fan is not mechanically blocked or that the motor bearings are not beginning to become worn.

2.29.7. Alarm nos. 49.7 – 51:7 "Supply air fan nos. 1A – 3A ripple error"

The size of air handling unit determines which alarms are enabled. GOLD 04-40 have one supply air fan (1A). GOLD 50-80 GOLD have two supply air fans (1A – 2A). GOLD 100-120 with up to 6.5 kW motors have 3 supply air fans (1A – 3A).

The alarms trip when the internal monitoring function in the motor controller indicates that harmful voltage peaks have exceeded the alarm limit.

Check the cable connections and, if appropriate instruments are available, also the appearance of the incoming alternating voltage in the power supply.

2.29.8. Alarm nos. 49.8 – 51:8 "Supply air fan nos. 1A – 3A phase error"

The size of air handling unit determines which alarms are enabled. GOLD 04-40 have one supply air fan (1A). GOLD 50-80 GOLD have two supply air fans (1A – 2A). GOLD 100-120 with up to 6.5 kW motors have 3 supply air fans (1A – 3A).

The alarms trip when the internal monitoring function in the motor controller indicates fluctuation voltage on the incoming phases.

Use a voltmeter to check that the voltage between the incoming phases does not differ by more than 5%. If possible, take measurements while the fans are operating.

2.29.9. Alarm nos. 49.9 – 51:9 "Supply air fan nos. 1A – 3A EEpro error"

The size of air handling unit determines which alarms are enabled. GOLD 04-40 have one supply air fan (1A). GOLD 50-80 GOLD have two supply air fans (1A – 2A). GOLD 100-120 with up to 6.5 kW motors have 3 supply air fans (1A – 3A).

The alarms trip when the internal monitoring function in the motor controller indicates malfunction in the internal EEprom.

Replace the motor controller.

2.29.10. Alarm nos. 49.10 – 51:10 "Supply air fan nos. 1A – 3A current limitation"

The size of air handling unit determines which alarms are enabled. GOLD 04-40 have one supply air fan (1A). GOLD 50-80 GOLD have two supply air fans (1A – 2A). GOLD 100-120 with up to 6.5 kW motors have 3 supply air fans (1A – 3A).

The alarms trip when the internal monitoring function in the motor controller indicates that the current supplied to the fan motor is so high that the internal speed reduction function continuously has to operate to keep the motor current below the max. permissible current limit.

Fault tracing tripped alarm GOLD E			<i>Document no.</i>	<i>Revision</i>	<i>Page</i>
					136 (146)
			<i>Date released</i>	<i>Supersedes</i>	
<i>Type of document</i>	<i>Drawn up by</i>	<i>Revised by</i>	<i>Released and published by</i>		
Instruktion	Bertil Sjunnesson	Magnus Hallén			

Try to rectify this by reducing the AHU's flow/pressure set point.

2.30. Alarm groups 52 – 54: SUPPLY AIR FAN nos. 1B, 2B and 3B.

The fans are numbered 1,2 and 3 starting from inspection door.

Fan designation B denotes motor controller 2 on the 10.5 kW motors.

Applies to the GOLD 80-2, GOLD 100-2 and GOLD 120-2.

2.30.1. Alarm nos. 52.1 – 54:1 "Supply air fan nos. 1B – 3B, communication error"

The alarms are enabled for GOLD 80-2, GOLD 100-2 and GOLD 120-2.

For 10.5kW fans with two motor controllers, 1B-3B denote motor controller 2 (4.0kW), for fans 1 – 3 counted from the inspection door.

The alarms trip when the IQLogic control unit does not have communication with the corresponding motor controller.

Fault tracing tripped alarm GOLD E			Document no.	Revision	Page
					137 (146)
Type of document		Drawn up by	Revised by	Released and published by	
Instruktion		Bertil Sjunnesson	Magnus Hallén	Supersedes	

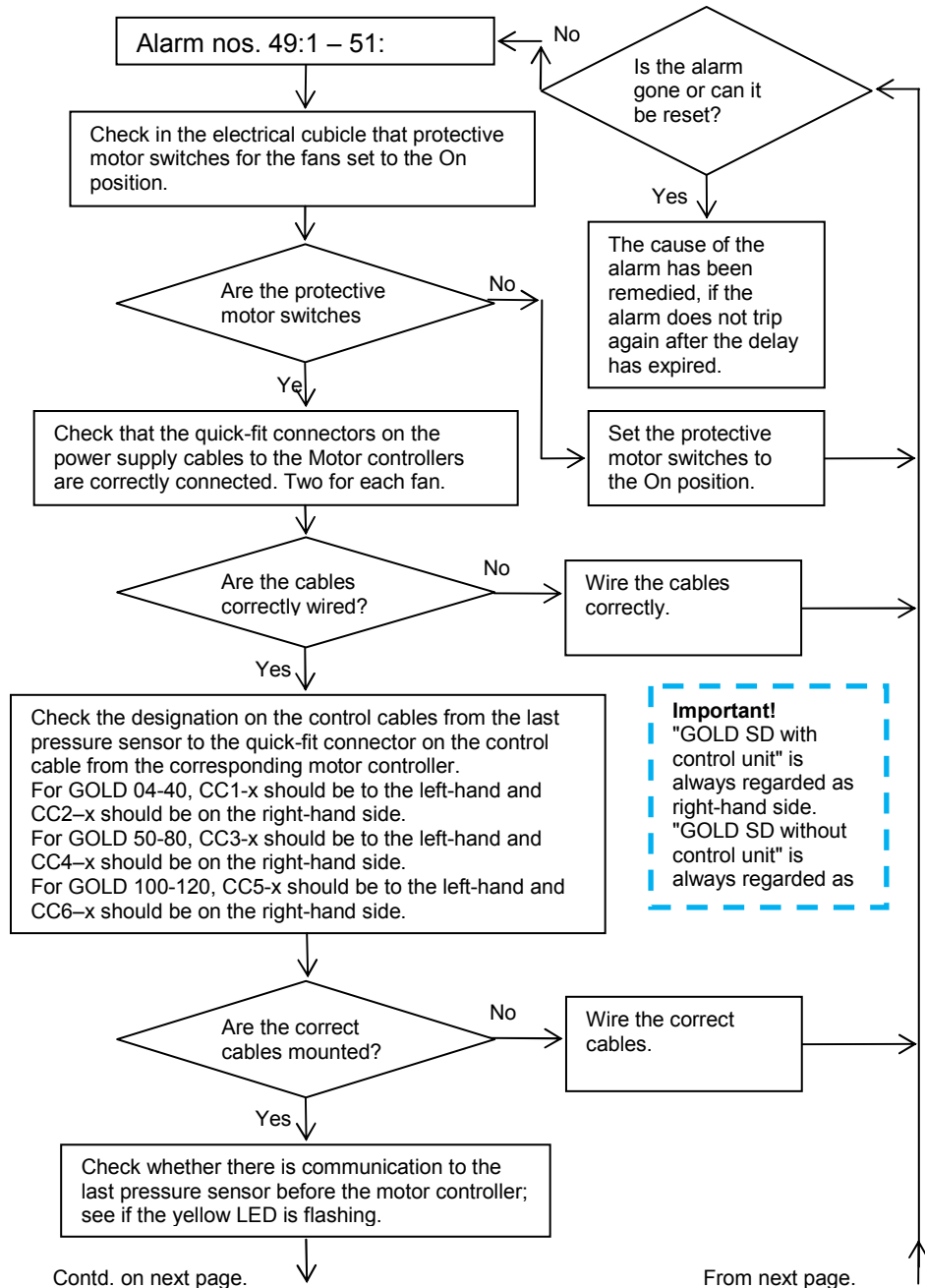

Fault tracing tripped alarm GOLD E			Document no.	Revision	Page
					138 (146)
			Date released	Supersedes	
Type of document Instruktion	Drawn up by Bertil Sjunnesson	Revised by Magnus Hallén	Released and published by		

From next page.

To previous page.

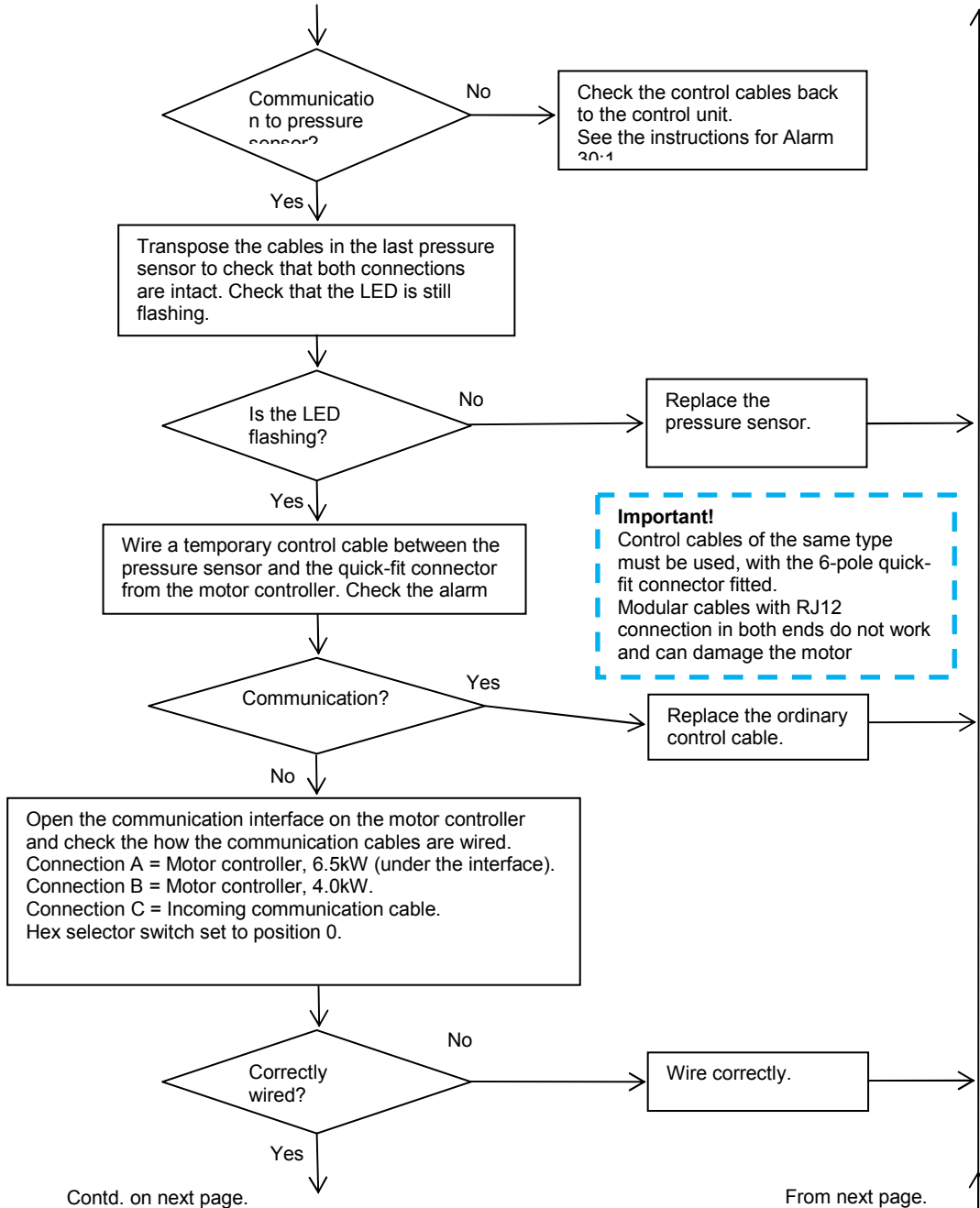

Contd. on next page.

From next page.

Fault tracing tripped alarm GOLD E			Document no.	Revision	Page 139 (146)
			Date released		Supersedes
Type of document Instruktion	Drawn up by Bertil Sjunnesson	Revised by Magnus Hallén	Released and published by		

From next page.

To previous page.

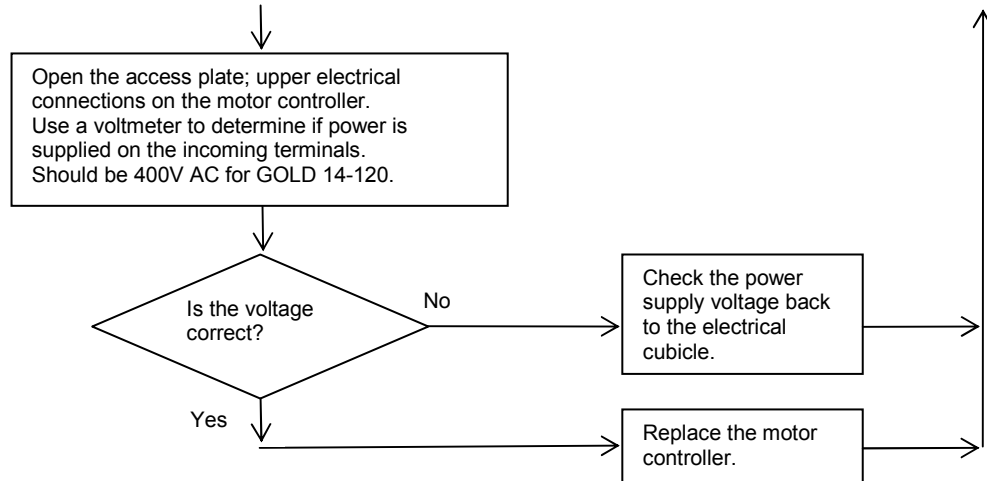

2.30.2. Alarm nos. 52.2 – 54:2 "Supply air fan nos. 1B – 3B over current"

The alarms are enabled for GOLD 80-2, GOLD 100-2 and GOLD 120-2.

For 10.5kW fans with two motor controllers, 1B-3B denote motor controller 2 (4.0kW), for fans 1 – 3 counted from the inspection door.

The alarms trip when the internal monitoring function in the EC motor controller detects current supplied to the motor above the alarm limit.

For troubleshooting see Alarm no. 49:2 above.

2.30.3. Alarm nos. 52.3 – 54:3 "Supply air fan nos. 1B – 3B under voltage"

The alarms are enabled for GOLD 80-2, GOLD 100-2 and GOLD 120-2.

For 10.5kW fans with two motor controllers, 1B-3B denote motor controller 2 (4.0kW), for fans 1 – 3 counted from the inspection door.

The alarms trip when the internal monitoring function in the EC motor controller detects voltage below the alarm limit.

For troubleshooting see Alarm no. 49:3 above.

2.30.4. Alarm nos. 52.4 – 54:4 "Supply air fan nos. 1B – 3B over voltage"

The alarms are enabled for GOLD 80-2, GOLD 100-2 and GOLD 120-2.

For 10.5kW fans with two motor controllers, 1B-3B denote motor controller 2 (4.0kW), for fans 1 – 3 counted from the inspection door.

The alarms trip when the internal monitoring function in the EC motor controller detects internal voltage above the alarm limit.

The alarm can occur when incoming power supply voltage exceeds the AHU's specified limit values. 3-phase, 400V +10% or 1-phase, 230 +10%.

Fault tracing tripped alarm GOLD E			<i>Document no.</i>	<i>Revision</i>	<i>Page</i>
					140 (146)
			<i>Date released</i>	<i>Supersedes</i>	
<i>Type of document</i>	<i>Drawn up by</i>	<i>Revised by</i>	<i>Released and published by</i>		
Instruktion	Bertil Sjunnesson	Magnus Hallén			

The alarm can also occur when the motor that rotates too fast (generator effect) because some other fan is discharging air across the AHU's fan.

Use a voltmeter to check the incoming voltage.

Also check whether the fans rotate due to external airflow when the AHU is stopped.

2.30.5. Alarm nos. 52.5 – 54:5 "Supply air fan nos. 1B – 3B over temperature"

The alarms are enabled for GOLD 80-2, GOLD 100-2 and GOLD 120-2.

For 10.5kW fans with two motor controllers, 1B-3B denote motor controller 2 (4.0kW), for fans 1 – 3 counted from the inspection door.

The alarms trip when the internal monitoring function in the EC motor controller detects an internal temperature above the alarm limit of 90°C.

For troubleshooting see Alarm no. 49:5 above.

2.30.6. Alarm nos. 52.6 – 54:6 "Supply air fan nos. 1B – 3B fan motor blocked"

The alarms are enabled for GOLD 80-2, GOLD 100-2 and GOLD 120-2.

For 10.5kW fans with two motor controllers, 1B-3B denote motor controller 2 (4.0kW), for fans 1 – 3 counted from the inspection door.

The alarms trip when the internal monitoring function in the motor controller indicates that the motor is blocked or operates too sluggishly when it is to start up.

Rotate the fan impeller by hand to check that the fan is not mechanically blocked or that the motor bearings are not beginning to become worn.

2.30.7. Alarm nos. 52.7 – 54:7 "Supply air fan nos. 1B – 3B ripple error"

The alarms are enabled for GOLD 80-2, GOLD 100-2 and GOLD 120-2.

For 10.5kW fans with two motor controllers, 1B-3B denote motor controller 2 (4.0kW), for fans 1 – 3 counted from the inspection door.

The alarms trip when the internal monitoring function in the motor controller indicates that harmful voltage peaks have exceeded the alarm limit.

Check the cable connections and, if appropriate instruments are available, also the appearance of the incoming alternating voltage in the power supply.

2.30.8. Alarm nos. 52.8 – 54:8 "Supply air fan nos. 1B – 3B phase error"

The alarms are enabled for GOLD 80-2, GOLD 100-2 and GOLD 120-2.

For 10.5kW fans with two motor controllers, 1B-3B denote motor controller 2 (4.0kW), for fans 1 – 3 counted from the inspection door.

The alarms trip when the internal monitoring function in the motor controller indicates fluctuation voltage on the incoming phases.

Use a voltmeter to check that the voltage between the incoming phases does not differ by more than 5%. If possible, take measurements while the fans are operating.

Fault tracing tripped alarm GOLD E			<i>Document no.</i>	<i>Revision</i>	<i>Page</i>
					141 (146)
			<i>Date released</i>	<i>Supersedes</i>	
<i>Type of document</i>	<i>Drawn up by</i>	<i>Revised by</i>	<i>Released and published by</i>		
Instruktion	Bertil Sjunnesson	Magnus Hallén			

2.30.9. Alarm nos. 52.9 – 54:9 "Supply air fan nos. 1B – 3B EEprom error"

The alarms are enabled for GOLD 80-2, GOLD 100-2 and GOLD 120-2.

For 10.5kW fans with two motor controllers, 1B-3B denote motor controller 2 (4.0kW), for fans 1 – 3 counted from the inspection door.

The alarms trip when the internal monitoring function in the motor controller indicates malfunction in the internal EEprom.

Replace the motor controller.

2.30.10. Alarm nos. 52.10 – 54:10 "Supply air fan nos. 1B – 3B current limitation"

The alarms are enabled for GOLD 80-2, GOLD 100-2 and GOLD 120-2.

For 10.5kW fans with two motor controllers, 1B-3B denote motor controller 2 (4.0kW), for fans 1 – 3 counted from the inspection door.

The alarms trip when the internal monitoring function in the motor controller indicates that the current supplied to the fan motor is so high that the internal speed reduction function continuously has to operate to keep the motor current below the max. permissible current limit.

Try to rectify this by reducing the AHU's flow/pressure set point.

2.31. Alarm groups 55 – 57: EXTRACT AIR FAN no. 1A, 2A and 3A.

The fans are numbered 1,2 and 3 starting from inspection door.

2.31.1. Alarm nos. 55.1 – 57:1 "Extract air fan no. 1A – 3A, communication error"

The size of air handling unit determines which alarms are enabled. GOLD 04-40 have one extract air fan (1A). GOLD 50-80 GOLD have two extract air fans (1A-2A). GOLD 100-120 with up to 6.5 kW motors have 3 extract air fans (1A-3A).

The alarms trip when the IQLogic control unit does not have communication with the corresponding motor controller.

For troubleshooting see Alarm no. 49:1 above.

2.31.2. Alarm nos. 55.2 – 57:2 "Extract air fan no. 1A – 3A over current"

The size of air handling unit determines which alarms are enabled. GOLD 04-40 have one extract air fan (1A). GOLD 50-80 GOLD have two extract air fans (1A-2A). GOLD 100-120 with up to 6.5 kW motors have 3 extract air fans (1A-3A).

The alarms trip when the internal monitoring function in the EC motor controller detects current supplied to the motor above the alarm limit.

For troubleshooting see Alarm no. 49:2 above.

2.31.3. Alarm nos. 55.3 – 57:3 "Extract air fan no. 1A – 3A under voltage"

The size of air handling unit determines which alarms are enabled. GOLD 04-40 have one extract air fan (1A). GOLD 50-80 GOLD have two extract air fans (1A-2A). GOLD 100-120 with up to 6.5 kW motors have 3 extract air fans (1A-3A).

The alarms trip when the internal monitoring function in the EC motor controller detects voltage below the alarm limit.

Fault tracing tripped alarm GOLD E			<i>Document no.</i>	<i>Revision</i>	<i>Page</i>
					142 (146)
			<i>Date released</i>	<i>Supersedes</i>	
<i>Type of document</i>	<i>Drawn up by</i>	<i>Revised by</i>	<i>Released and published by</i>		
Instruktion	Bertil Sjunnesson	Magnus Hallén			

For troubleshooting see Alarm no. 49:3 above.

2.31.4. Alarm nos. 55.4 – 57:4 "Extract air fan no. 1A – 3A over voltage"

The size of air handling unit determines which alarms are enabled. GOLD 04-40 have one extract air fan (1A). GOLD 50-80 GOLD have two extract air fans (1A-2A). GOLD 100-120 with up to 6.5 kW motors have 3 extract air fans (1A-3A).

The alarms trip when the internal monitoring function in the EC motor controller detects internal voltage above the alarm limit.

The alarm can occur when incoming power supply voltage exceeds the AHU's specified limit values. 3-phase, 400V +10% or 1-phase, 230 +10%.

The alarm can also occur when the motor that rotates too fast (generator effect) because some other fan is discharging air across the AHU's fan.

Use a voltmeter to check the incoming voltage.

Also check whether the fans rotate due to external airflow when the AHU is stopped.

2.31.5. Alarm nos. 55.5 – 57:5 "Extract air fan no. 1A – 3A over temperature"

The size of air handling unit determines which alarms are enabled. GOLD 04-40 have one extract air fan (1A). GOLD 50-80 GOLD have two extract air fans (1A-2A). GOLD 100-120 with up to 6.5 kW motors have 3 extract air fans (1A-3A).

The alarms trip when the internal monitoring function in the EC motor controller detects an internal temperature above the alarm limit of 90°C.

For troubleshooting see Alarm no. 49:5 above.

2.31.6. Alarm nos. 55.6 – 57:6 "Extract air fan no. 1A – 3A fan motor blocked"

The size of air handling unit determines which alarms are enabled. GOLD 04-40 have one extract air fan (1A). GOLD 50-80 GOLD have two extract air fans (1A-2A). GOLD 100-120 with up to 6.5 kW motors have 3 extract air fans (1A-3A).

The alarms trip when the internal monitoring function in the motor controller indicates that the motor is blocked or operates too sluggishly when it is to start up.

Rotate the fan impeller by hand to check that the fan is not mechanically blocked or that the motor bearings are not beginning to become worn.

2.31.7. Alarm nos. 55.7 – 57:7 "Extract air fan no. 1A – 3A ripple error"

The size of air handling unit determines which alarms are enabled. GOLD 04-40 have one extract air fan (1A). GOLD 50-80 GOLD have two extract air fans (1A-2A). GOLD 100-120 with up to 6.5 kW motors have 3 extract air fans (1A-3A).

The alarms trip when the internal monitoring function in the motor controller indicates that harmful voltage peaks have exceeded the alarm limit.

Check the cable connections and, if appropriate instruments are available, also the appearance of the incoming alternating voltage in the power supply.

Fault tracing tripped alarm GOLD E			<i>Document no.</i>	<i>Revision</i>	<i>Page</i>
					143 (146)
			<i>Date released</i>	<i>Supersedes</i>	
<i>Type of document</i>	<i>Drawn up by</i>	<i>Revised by</i>	<i>Released and published by</i>		
Instruktion	Bertil Sjunnesson	Magnus Hallén			

2.31.8. Alarm nos. 55.8 – 57:8 "Extract air fan no. 1A – 3A phase error"

The size of air handling unit determines which alarms are enabled. GOLD 04-40 have one extract air fan (1A). GOLD 50-80 GOLD have two extract air fans (1A-2A). GOLD 100-120 with up to 6.5 kW motors have 3 extract air fans (1A-3A).

The alarms trip when the internal monitoring function in the motor controller indicates fluctuation voltage on the incoming phases.

Use a voltmeter to check that the voltage between the incoming phases does not differ by more than 5%. If possible, take measurements while the fans are operating.

2.31.9. Alarm nos. 55.9 – 57:9 "Extract air fan no. 1A – 3A EEpro error"

The size of air handling unit determines which alarms are enabled. GOLD 04-40 have one extract air fan (1A). GOLD 50-80 GOLD have two extract air fans (1A-2A). GOLD 100-120 with up to 6.5 kW motors have 3 extract air fans (1A-3A).

The alarms trip when the internal monitoring function in the motor controller indicates malfunction in the internal EEprom.

Replace the motor controller.

2.31.10. Alarm nos. 55.10 – 57:10 "Extract air fan no. 1A – 3A current limitation"

The size of air handling unit determines which alarms are enabled. GOLD 04-40 have one extract air fan (1A). GOLD 50-80 GOLD have two extract air fans (1A-2A). GOLD 100-120 with up to 6.5 kW motors have 3 extract air fans (1A-3A).

The alarms trip when the internal monitoring function in the motor controller indicates that the current supplied to the fan motor is so high that the internal speed reduction function continuously has to operate to keep the motor current below the max. permissible current limit.

Try to rectify this by reducing the AHU's flow/pressure set point.

2.32. Alarm groups 58 – 60: EXTRACT AIR FAN no. 1B, 2B and 3B.

The fans are numbered 1,2 and 3 starting from inspection door.

Fan designation B denotes motor controller 2 on the 10.5 kW motors.

Applies to the GOLD 80-2, GOLD 100-2 and GOLD 120-2.

2.32.1. Alarm nos. 58.1 – 60:1 "Extract air fan no. 1B – 3B, communication error"

The alarms are enabled for GOLD 80-2, GOLD 100-2 and GOLD 120-2.

For 10.5kW fans with two motor controllers, 1B-3B denote motor controller 2 (4.0kW), for fans 1 – 3 counted from the inspection door.

The alarms trip when the IQLogic control unit does not have communication with the corresponding motor controller.

For troubleshooting see Alarm no. 52:1 above.

Fault tracing tripped alarm GOLD E			<i>Document no.</i>	<i>Revision</i>	<i>Page</i>
					144 (146)
			<i>Date released</i>	<i>Supersedes</i>	
<i>Type of document</i>	<i>Drawn up by</i>	<i>Revised by</i>	<i>Released and published by</i>		
Instruktion	Bertil Sjunnesson	Magnus Hallén			

2.32.2. Alarm nos. 58.2 – 60:2 "Extract air fan no. 1B – 3B over current"

The alarms are enabled for GOLD 80-2, GOLD 100-2 and GOLD 120-2.

For 10.5kW fans with two motor controllers, 1B-3B denote motor controller 2 (4.0kW), for fans 1 – 3 counted from the inspection door.

The alarms trip when the internal monitoring function in the EC motor controller detects current supplied to the motor above the alarm limit.

For troubleshooting see Alarm no. 52:2 above.

2.32.3. Alarm nos. 58.3 – 60:3 "Extract air fan no. 1B – 3B under voltage"

The alarms are enabled for GOLD 80-2, GOLD 100-2 and GOLD 120-2.

For 10.5kW fans with two motor controllers, 1B-3B denote motor controller 2 (4.0kW), for fans 1 – 3 counted from the inspection door.

The alarms trip when the internal monitoring function in the EC motor controller detects voltage below the alarm limit.

For troubleshooting see Alarm no. 52:3 above.

2.32.4. Alarm nos. 58.4 – 60:4 "Extract air fan no. 1B – 3B over voltage"

The alarms are enabled for GOLD 80-2, GOLD 100-2 and GOLD 120-2.

For 10.5kW fans with two motor controllers, 1B-3B denote motor controller 2 (4.0kW), for fans 1 – 3 counted from the inspection door.

The alarms trip when the internal monitoring function in the EC motor controller detects internal voltage above the alarm limit.

The alarm can occur when incoming power supply voltage exceeds the AHU's specified limit values. 3-phase, 400V +10% or 1-phase, 230 +10%.

The alarm can also occur when the motor that rotates too fast (generator effect) because some other fan is discharging air across the AHU's fan.

Use a voltmeter to check the incoming voltage.

Also check whether the fans rotate due to external airflow when the AHU is stopped.

2.32.5. Alarm nos. 58.5 – 60:5 "Extract air fan no. 1B – 3B over temperature"

The alarms are enabled for GOLD 80-2, GOLD 100-2 and GOLD 120-2.

For 10.5kW fans with two motor controllers, 1B-3B denote motor controller 2 (4.0kW), for fans 1 – 3 counted from the inspection door.

The alarms trip when the internal monitoring function in the EC motor controller detects an internal temperature above the alarm limit of 90°C.

For troubleshooting see Alarm no. 52:5 above.

2.32.6. Alarm nos. 58.6 – 60:6 "Extract air fan no. 1B – 3B fan motor blocked"

The alarms are enabled for GOLD 80-2, GOLD 100-2 and GOLD 120-2.

For 10.5kW fans with two motor controllers, 1B-3B denote motor controller 2 (4.0kW), for fans 1 – 3 counted from the inspection door.

Fault tracing tripped alarm GOLD E			<i>Document no.</i>	<i>Revision</i>	<i>Page</i>
					145 (146)
			<i>Date released</i>	<i>Supersedes</i>	
<i>Type of document</i>	<i>Drawn up by</i>	<i>Revised by</i>	<i>Released and published by</i>		
Instruktion	Bertil Sjunnesson	Magnus Hallén			

The alarms trip when the internal monitoring function in the motor controller indicates that the motor is blocked or operates too sluggishly when it is to start up.

Rotate the fan impeller by hand to check that the fan is not mechanically blocked or that the motor bearings are not beginning to become worn.

2.32.7. Alarm nos. 58.7 – 60:7 "Extract air fan no. 1B – 3B ripple error"

The alarms are enabled for GOLD 80-2, GOLD 100-2 and GOLD 120-2.

For 10.5kW fans with two motor controllers, 1B-3B denote motor controller 2 (4.0kW), for fans 1 – 3 counted from the inspection door.

The alarms trip when the internal monitoring function in the motor controller indicates that harmful voltage peaks have exceeded the alarm limit.

Check the cable connections and, if appropriate instruments are available, also the appearance of the incoming alternating voltage in the power supply.

2.32.8. Alarm nos. 58.8 – 60:8 "Extract air fan no. 1B – 3B phase error"

The alarms are enabled for GOLD 80-2, GOLD 100-2 and GOLD 120-2.

For 10.5kW fans with two motor controllers, 1B-3B denote motor controller 2 (4.0kW), for fans 1 – 3 counted from the inspection door.

The alarms trip when the internal monitoring function in the motor controller indicates fluctuation voltage on the incoming phases.

Use a voltmeter to check that the voltage between the incoming phases does not differ by more than 5%. If possible, take measurements while the fans are operating.

2.32.9. Alarm nos. 58.9 – 60:9 "Extract air fan no. 1B – 3B EEprom error"

The alarms are enabled for GOLD 80-2, GOLD 100-2 and GOLD 120-2.

For 10.5kW fans with two motor controllers, 1B-3B denote motor controller 2 (4.0kW), for fans 1 – 3 counted from the inspection door.

The alarms trip when the internal monitoring function in the motor controller indicates malfunction in the internal EEprom.

Replace the motor controller.

2.32.10. Alarm nos. 58.10 – 60:10 "Extract air fan no. 1B – 3B current limitation"

The alarms are enabled for GOLD 80-2, GOLD 100-2 and GOLD 120-2.

For 10.5kW fans with two motor controllers, 1B-3B denote motor controller 2 (4.0kW), for fans 1 – 3 counted from the inspection door.

The alarms trip when the internal monitoring function in the motor controller indicates that the current supplied to the fan motor is so high that the internal speed reduction function continuously has to operate to keep the motor current below the max. permissible current limit.

Try to rectify this by reducing the AHU's flow/pressure set point.

Fault tracing tripped alarm GOLD E			<i>Document no.</i>	<i>Revision</i>	<i>Page</i>
					146 (146)
			<i>Date released</i>	<i>Supersedes</i>	
<i>Type of document</i> Instruktion	<i>Drawn up by</i> Bertil Sjunnesson	<i>Revised by</i> Magnus Hallén	<i>Released and published by</i>		