

GLOBAL

Pressure Transducer GLOBAL

1. General

The pressure transducer is designed for use in ventilation systems intended for variable airflow by keeping the pressure constant in the ducting system. The pressure sensor can also be used for the defrosting function for plate heat exchangers. The pressure sensor is the same as those used for measuring the flows in the GLOBAL units.

Description

The enclosed pressure sensor contains a temperature-compensated differential-pressure sensor. The pressure transducer is supplied with a hose (30cm long) and through-connector nipples (95 mm).

Indicating light emitting diodes

LD1 Indicates with a steady green glow 24 V DC supplied to circuit card.

LD2 Indicates with a flashing yellow glow that communication is in progress.

2. Installation

Mount the pressure transducer at a suitable location, as described in Fig.1 and 2. The pressure transducer's performance is not affected by the location where it is mounted. In consideration of its degree of protection, the pressure transducer shall not be mounted with the pressure connections pointing upward.

Connect the pressure sensor connections to the measurement tapplings in the air handling unit/power roof ventilator or on ducts. Notice the plus and the minus symbols on the pressure transducer connections.

The measurement hoses to the pressure transducer must be arranged lower than the transducer itself. If the measurement hoses are arranged higher than the transducer, there is risk of condensate inside the hoses running down into, collecting inside and ruining the pressure transducer.

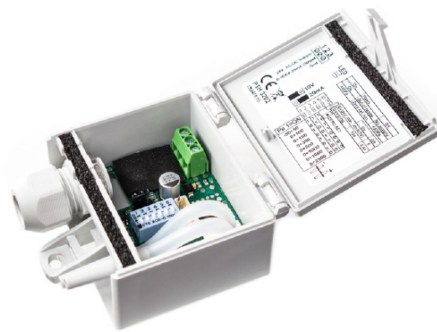

Fig.1: PRESSURE SENSOR 0...10V CID521249



Fig.2: PRESSURE SENSOR Modbus CID521250

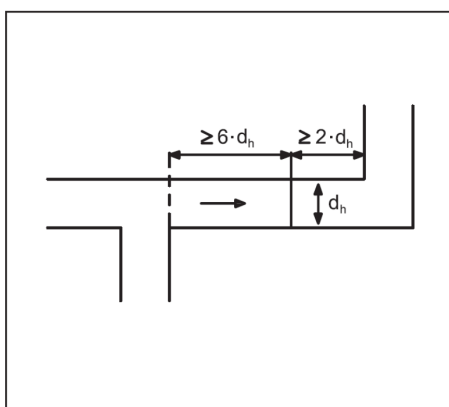

Fig.3: Pressure sensor location

We reserve the right to alter specifications.

20201214

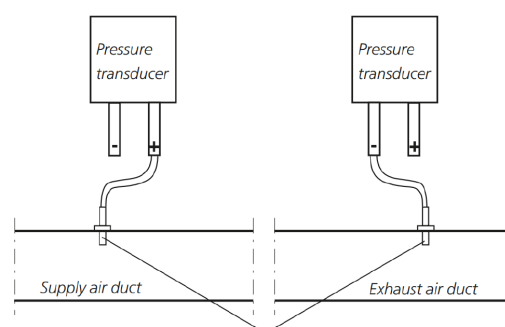

Fig.4: Pressure sensor location

N.B! In some cases you might need to cut the measurement tapplings to shorten them. They should not protrude more than 10 mm from the inner wall inside the duct.

Swegon

2.1 Pressure regulation

Pressure transducers are normally fitted to air ducts.

The function of a pressure transducer is to measure the pressure differential between the pressure inside the ducting and atmospheric pressure.

For the Modbus pressure sensor: set the function selector switch on the pressure sensor to position 5 for sensors that measure in the supply air duct, and to position 6 for sensors that measure in the extract air duct.

Set the air handling unit for pressure regulation.

The required pressure setpoint can be set and the current pressure readings can be viewed via the hand-held micro terminal of the air handling unit.

TECHNICAL DATA

Supply voltage:	24VAC ±15% 50/60Hz
Current consumption:	-20 to +5°C: 4VA 5-40°C: 2.5VA
Output signal:	0-10/2-10VDC
RJ12 cable length:	3 meters (CID521250 only)
measurement ranges:	-50 to +50Pa, 0-100/150/300/ 500/1000/1600/2500Pa
Automatic damping:	0.4 or 10 seconds
Accuracy, typical:	±1% > 300Pa, ±4Pa < 300Pa
Linearity:	< ±1% full scale
Maximum pressure:	5 kPa
Protection class:	IP54
Ambient temperature:	-20 to +40°C
Dimensions:	74 x 36 x 91mm
Hose dimensions:	2 x 6.2mm
Approval:	CE: EN 61000-6-2 CE: EN 61000-6-DIMEN-

SIONS

Dimensions

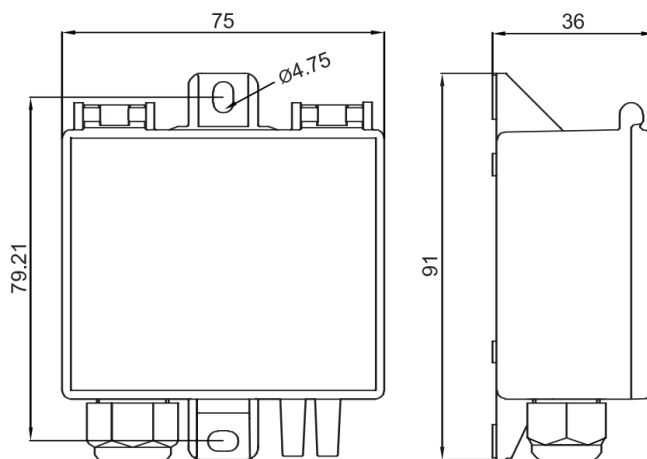

Wiring CID521249

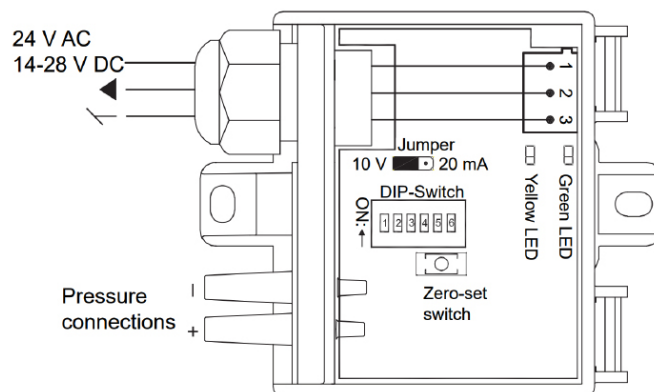

Wiring CID521250

Table 1 : Sélecteur - Keuzeschakelaar - Selector - Schalter

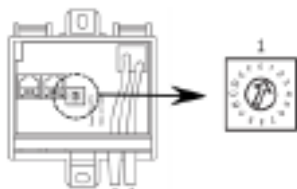

Mode	Pulsion-Toevoer Supply-Zuluftgerät	Extraction-Afvoer Exhaust-Abluftgerät
CP*	5	6
CA**	1	2
Defrost*		C

* =Convert Volt in pascal «0-10v ≡ 0-500Pa »
 ** = factory installed, differential fan pressure

Fig.3 : With RJ12 connector in TAC5 box

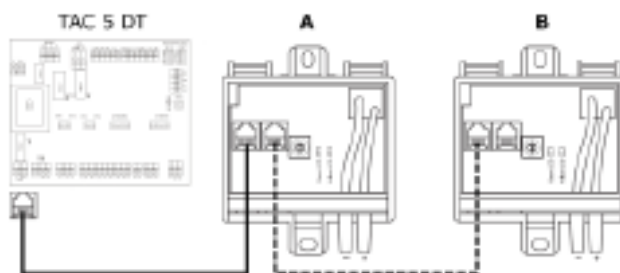

Fig.4 : without RJ12 connector in TAC5 box

