





WIRING DIAGRAM COMPO AIR HANDLING UNITS

 This wiring diagram is only an addition to our installation and operation manuals, available on our website for download.

 All internal components (fans, controls, sensors, actuators...) to the control board are pre-wired.
The power supply must be connected to the safety isolating switch by a qualified electrician. Earthing is obligatory.

 All electrical connections must be made by a qualified electrician and in accordance with local rules and regulations.

 Residual current circuit breaker 300mA class B or B+

 Fuse protection (D-type, "slow")
D – 10.000 A – AC3

Changes			Name	Date		Page
Name	Date	Draw.:	G. Beckers	16/01/2019		1
		check.:				
		Norm:			Application: General	of 13
Subject:	Compo_20190114.spl7					

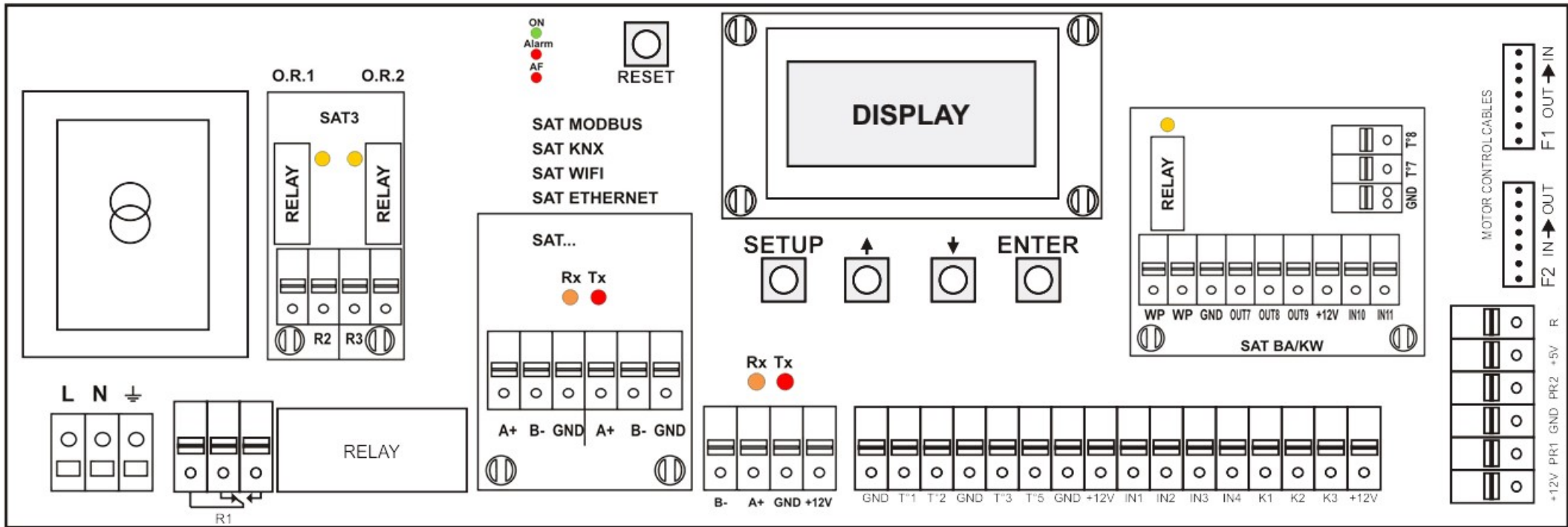

⚠ Caution The "SAT" circuits board must be plugged in correctly before the main circuit is powered. Wrong positioning can damage both circuits permanently.

Changes		Name	Date	Page
Name	Date	Draw.:	G. Beckers	
		check.:		
		Norm:		
Subject:	Compo_20190114.spl7		Application:	of
			CB2 TAC5 SC	13

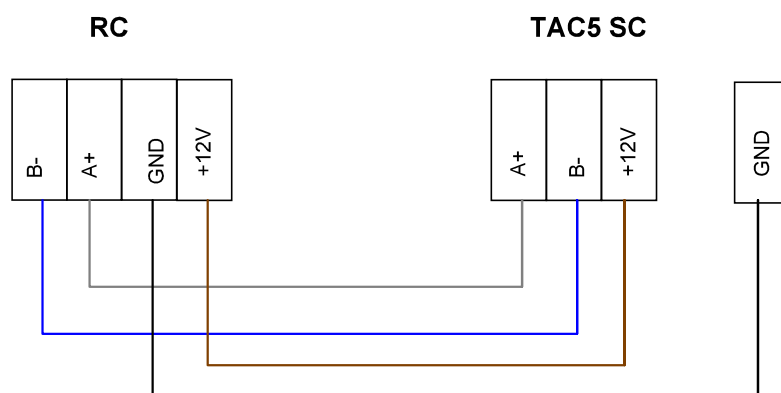
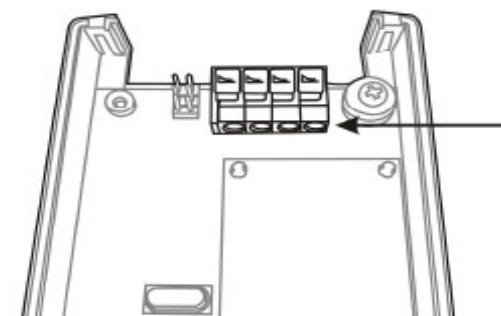
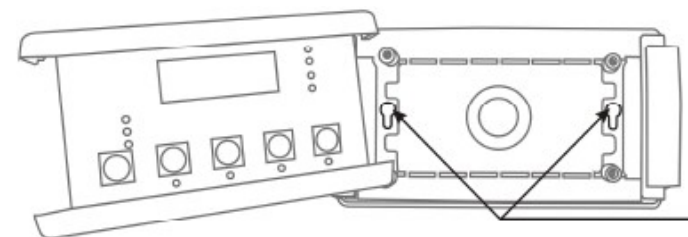
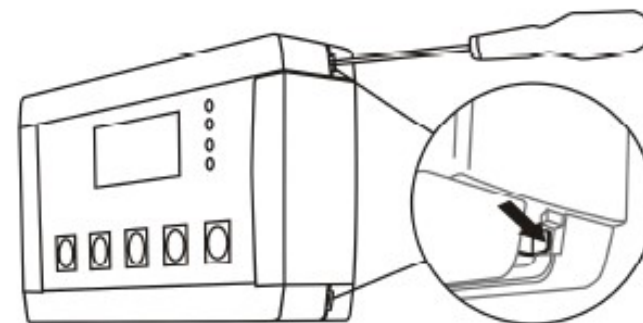

Changes		Name	Date	Application: KIT RC	Page
Name	Date	Draw.: Laurent	October 2018		3
		check.:			
		Norm:			
Subject:	Compo_20190114.spl7				of 13

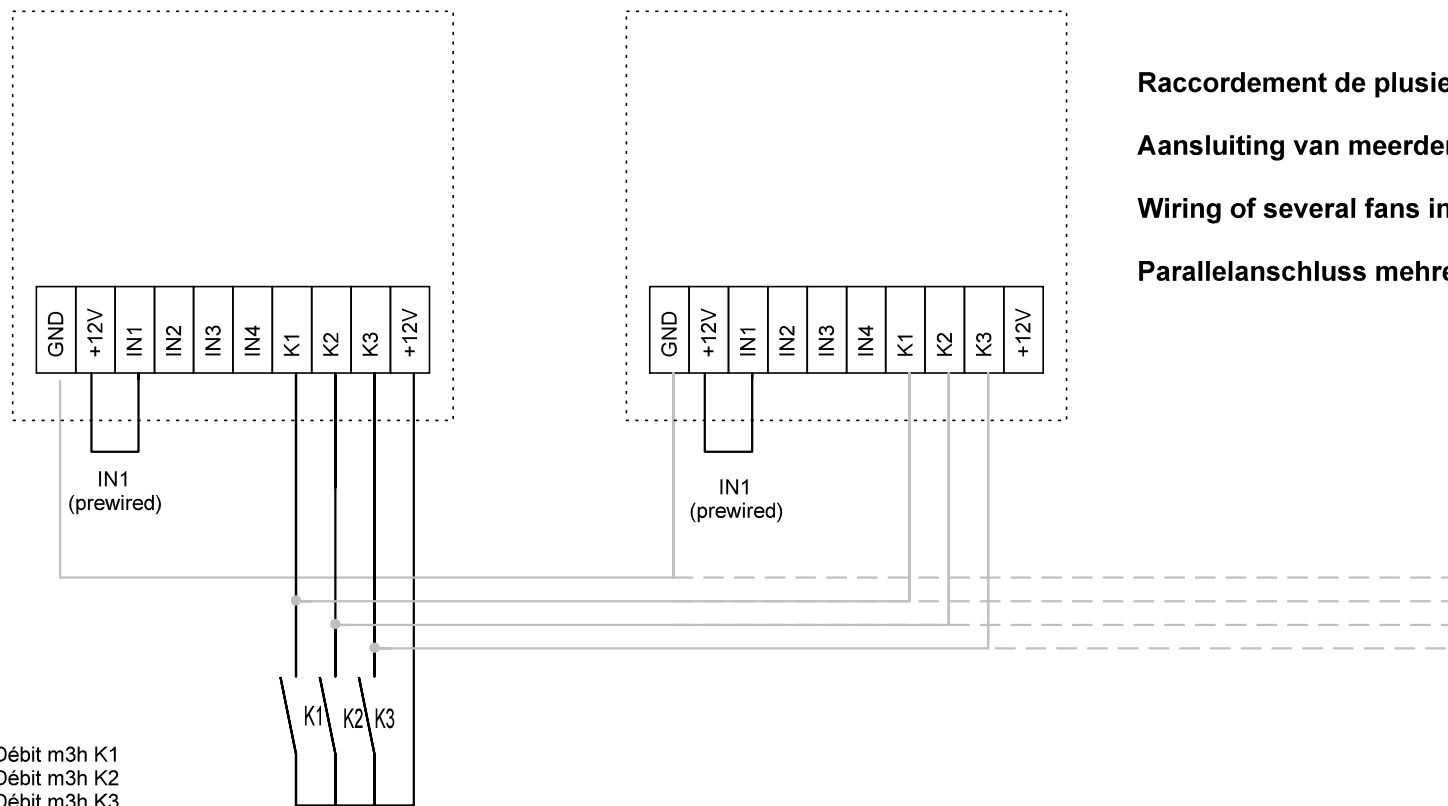

Raccordement de plusieurs ventilateurs en parallèle - Mode CA

Aansluiting van meerdere ventiatoren in parallel - Mode CA

Wiring of several fans in parallel - Mode CA

Parallelanschluss mehrerer Ventilatoren - CA Modus

K1 fermé => Débit m3h K1
 K2 fermé => Débit m3h K2
 K3 fermé => Débit m3h K3
 K1/K2/K3 ouverts => softstop

K1 closed => Airflow m3h K1
 K2 closed => Airflow m3h K2
 K3 closed => Airflow m3h K3
 K1/K2/K3 open => softstop

K1 gesloten => Debiet m3h K1
 K2 gesloten => Debiet m3h K2
 K3 gesloten => Debiet m3h K3
 K1/K2/K3 open => softstop

K1 geschl. => Vol. m3h K1
 K2 geschl. => Vol. m3h K2
 K3 geschl. => Vol. m3h K3
 K1/K2/K3 offen => softstop

Attention. K1/K2/K3: Utilisez des contacts externes dorés.
 Impédance d'entrée minimum = 150k . Courant < 0,5 mA. Signaux externes: impédance maximum 1500 Ohm .

Opgelet. K1/K2/K3: Gebruikt vergulde contacten.
 Minimum input impedantie = 150k . Stroom < 0,5 mA. Externe signalen: maximum impedantie = 1500 Ohm .

Caution. K1/K2/K3: Use gold plated contacts.
 Minimum input impedance = 150k . Current < 0,5 mA. External signals: maximum impedance = 1500 Ohm .

Achtung K1/K2/K3 : Vergoldete Kontakte benutzen.
 Minimale Eingangsimpedanz = 150k . Strom < 0,5 mA. Aussen Signale : Maximum Impedanz 1500 Ohm .

Changes		Name	Date	Page
Name	Date	Draw.:	G. Beckers	
		check.:		
		Norm:		
Subject:	Compo_20190114.spl7		Application: Modus CA	of 13

Raccordement de plusieurs ventilateurs en parallèle - Mode LS,CPs,CP

Aansluiting van meerdere ventiatoren in parallel - LS,CPs,CPs Modus

Wiring of several fans in parallel - LS,CPs,CPs Mode

Parallelanschluss mehrerer Ventilatoren - LS,CPs,CPs Modus

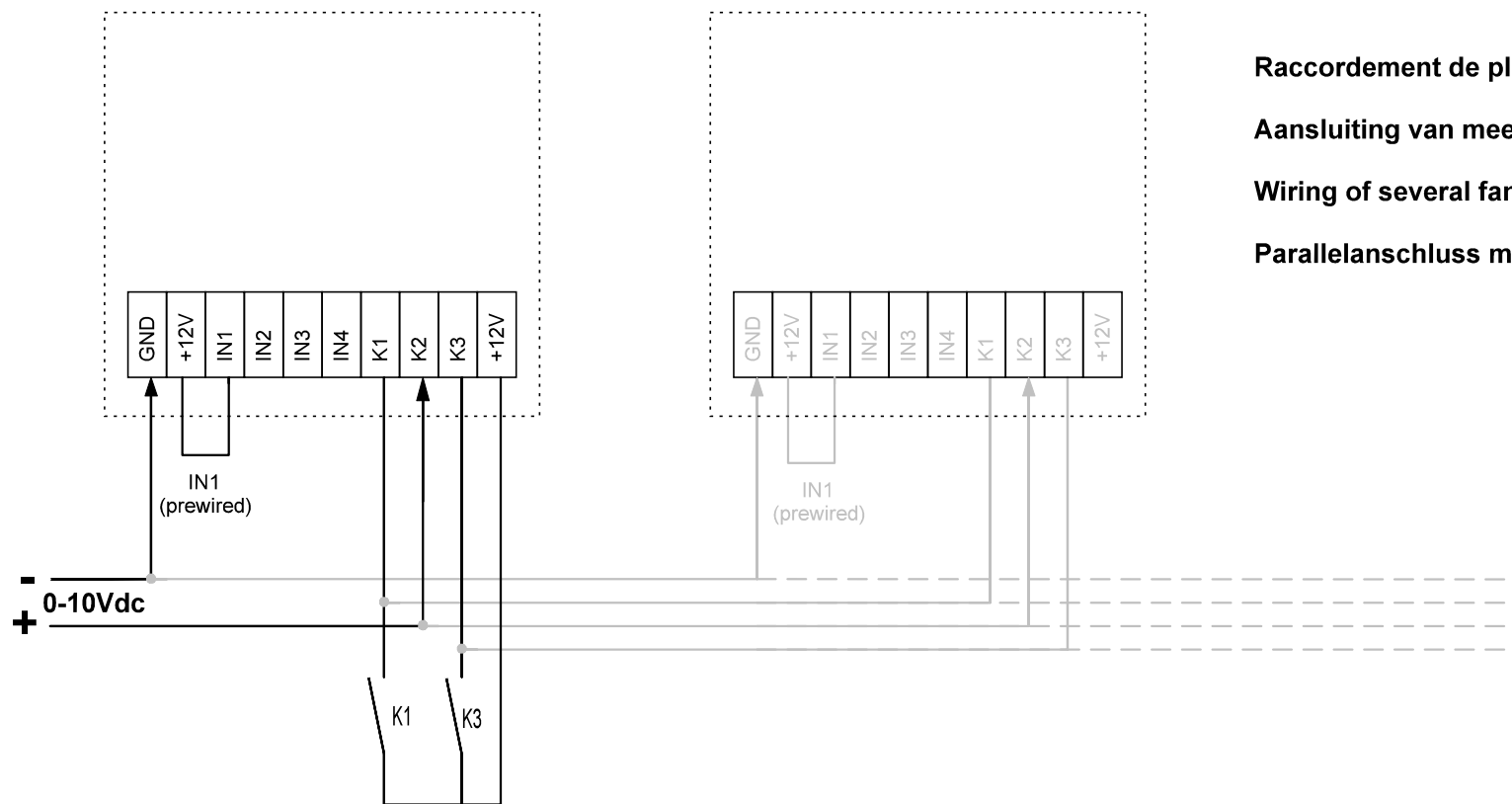

K1 fermé => Softstart
 K1 ouvert =>Softstop
 K2 => signal 0-10V
 Pas signal sur K2 si mode CPf
 K1+K3 fermé=> % sur K3 actif
 K3 ouvert => % sur K3 inactif

K1 closed=> Softstart
 K1 open =>Softstop
 K2 => 0-10V signal
 No signal on K2 if mode CPf
 K1+K3 closed=> % on K3 active
 K3 open => % sur K3 inactive

K1 gesloten=> Softstart
 K1 open =>Softstop
 K2 => 0-10V signal
 Geen signal op K2 als CPf modus
 K1+K3 gesloten=> % op K3 actief
 K3 open => % sur K3 inactief

K1 geschl. => Softstart
 K1 offen =>Softstop
 K2 => 0-10V Signal
 Keine Signal an K2 als CPf Modus
 K1+K3 geschl.=> % K3 aktiv
 K3 offen => % sur K3 inaktiv

Attention. K1/K2/K3: Utilisez des contacts externes dorés.
 Impédance d'entrée minimum = 150k . Courant < 0,5 mA. Signaux externes: impédance maximum 1500 Ohm .

Opgelet. K1/K2/K3: Gebruikt vergulde contacten.
 Minimum input impedantie = 150k . Stroom < 0,5 mA. Externe signalen: maximum impedantie = 1500 Ohm .

Caution. K1/K2/K3: Use gold plated contacts.
 Minimum input impedance = 150k . Current < 0,5 mA. External signals: maximum impedance = 1500 Ohm .

Achtung K1/K2/K3 : Vergoldete Kontakte benutzen.
 Minimale Eingangsimpedanz = 150k . Strom < 0,5 mA. Aussen Signale : Maximum Impedanz 1500 Ohm .

Changes		Name	Date	Page	
Name	Date	Draw.:	G. Beckers		5
		check.:			
		Norm:		of 13	
Subject:	Compo_20190114.spl7		Application: Modus LS-CPf-CPs		

Raccordement de plusieurs circuit à un COM4 (commutateur 4 positions)
Aansluiting van meerdere controlcircuits aan 1 COM 4 (4 positie schakelaar)
Wiring of several boards on 1 COM4 (4 position switch)
Anschluss von Mehr Platine ann 1 COM4 (4 Positionen Schalter)

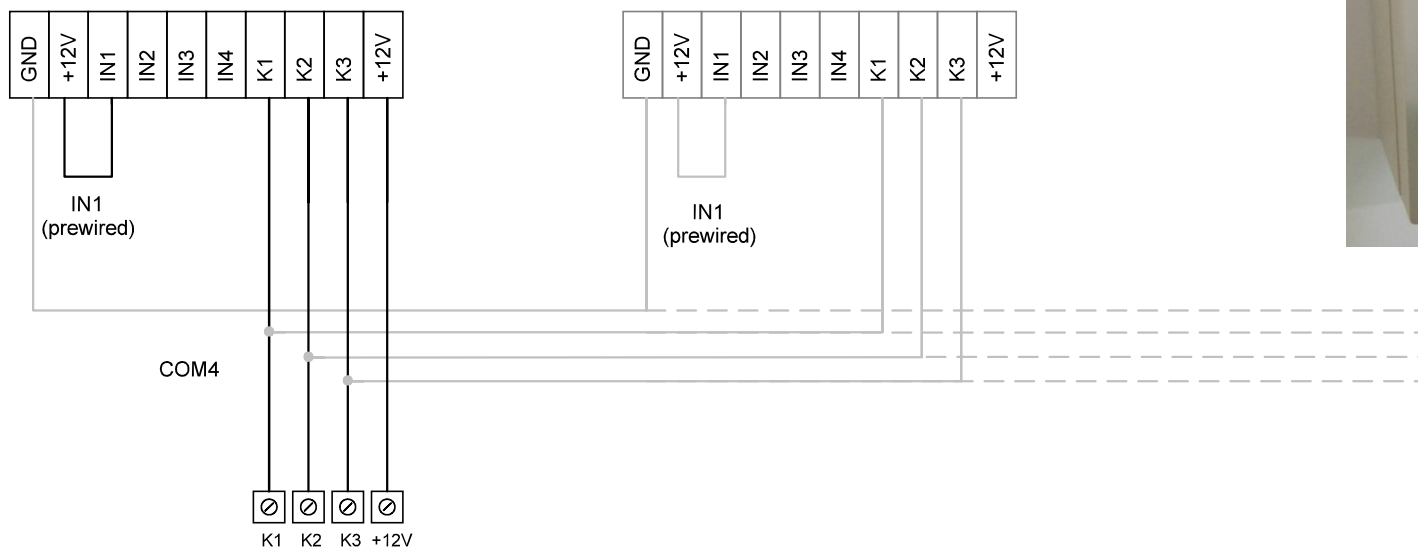

Changes			Name	Date	Page
Name	Date	Draw.:	G. Beckers	January 2019	
		check.:			
		Norm:			
Subject:	Compo_20190114.spl7			Application: COM 4 Switch	of 13

Sorties alarmes

Alarmen uitgangen

Alarms outputs

Alarm-Ausgänge

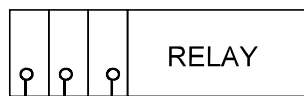

R1

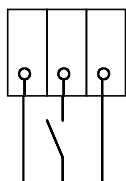
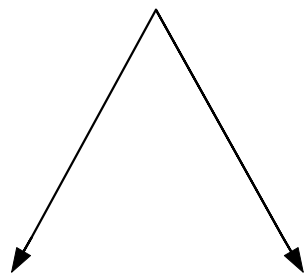

AL DEFAULT
OFF

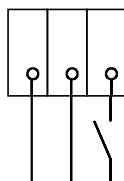

AL DEFAULT
ON

Changes

Name

Date

Page

Name

Date

Draw.:

Laurent

October 2018

7

check.:

Norm:

Application:
Alarms

of

13

Subject:

Compo_20190114.spl7

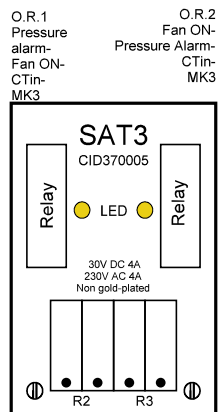

TAC5 Controller

Marche ventilateur

Werking van de ventilator

Fan ON

Betriebszustand des Ventilators

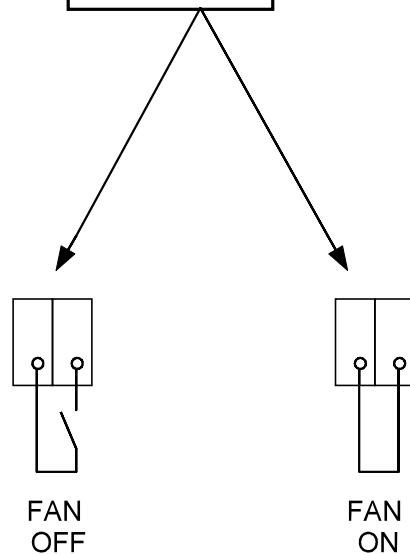

Peut aussi être configuré comme étant connecté sur OR1 (voir mode d'emploi)

Kan ook worden geconfigureerd als verbonden op OR1 (zie aanleiding instructies)

Can also be configured as being connected to OR1 (see instructions manual)

Kann auch als auf OR1 verbunden konfiguriert werden (siehe Gebrauchsanweisung)

Changes

Changes		Name	Date	Configuration of function: Basic setup / Air flow regulation / Constant pressure	Page
Name	Date	Draw.: Laurent	October 2018		8
		check.:			
		Norm:		Application: Fan Start/Stop	of 13
Subject:	Compo_20190114.spl7				

TAC5 Controller

Ouverture/fermeture des clapets CT

Openen/sluiten van de CT kleppen

Opening/closing of CT dampers

Öffnen/Schliessen der Jalousieklappen

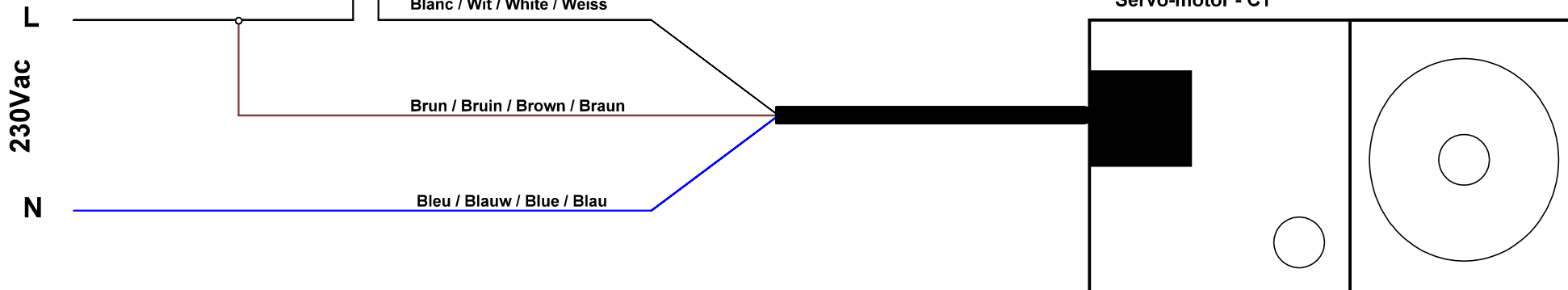
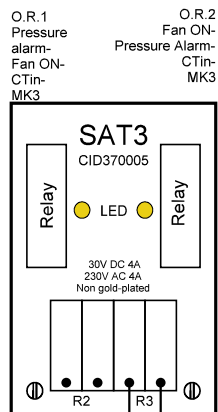

Peut aussi être configuré comme étant connecté sur OR1 (voir mode d'emploi)

Kan ook worden geconfigureerd als verbonden op OR1 (zie aanleiding instructies)

Can also be configured as being connected to OR1 (see instructions manual)

Kann auch als auf OR1 verbunden konfiguriert werden (siehe Gebrauchsanweisung)

Changes		Name	Date	Configuration of function: Basic setup / Air flow regulation / Constant pressure	Page
Name	Date	Draw.: Laurent	October 2018		9
		check.:			
		Norm:		Application: Control CT	of 13
Subject:	Compo_20190114.spl7				

TAC5 Controller
Caisson mélangeur MK3
Mengkast MK3
Mixing cabinet MK3
Mischkammer MK3

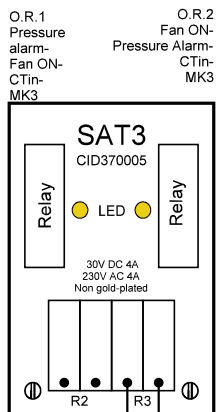

230Vac
Z

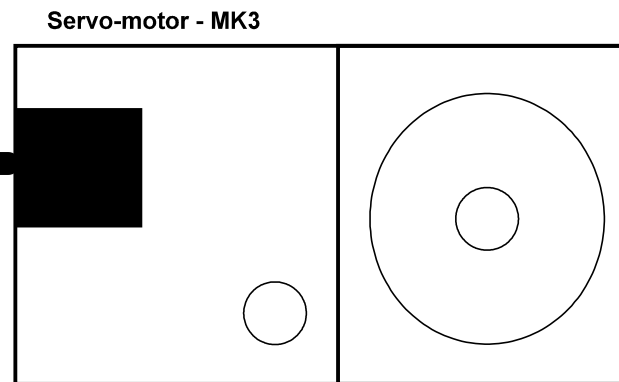
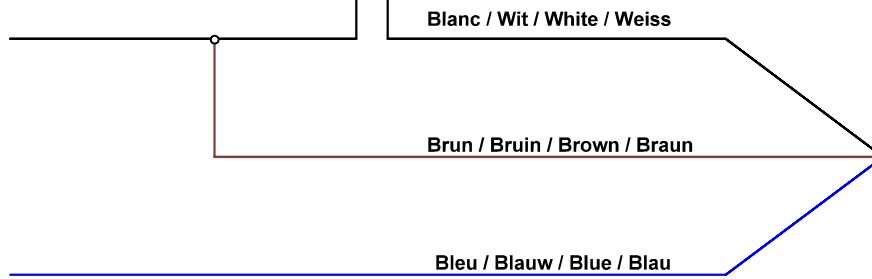

Peut aussi être configuré comme étant connecté sur OR1 (voir mode d'emploi)

Kan ook worden geconfigureerd als verbonden op OR1 (zie aanleiding instructies)

Can also be configured as being connected to OR1 (see instructions manual)

Kann auch als auf OR1 verbunden konfiguriert werden (siehe Gebrauchsanweisung)

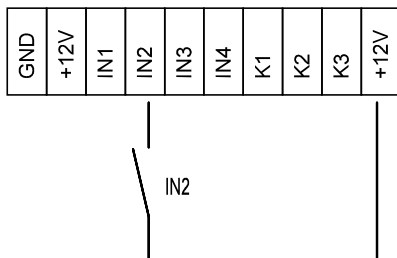

IN2 fermé=> MK3 actif
 IN2 ouvert=> MK3 inactif

IN2 gesloten=> MK3 actief
 IN2 open=> MK3 inactief

IN2 closed=> MK3 active
 IN2 open=> MK3 inactive

IN2 geschl.=> MK3 aktif
 IN2 offen=> MK3 inaktiv

Changes		Name	Date	Configuration of function: Basic setup / Air flow regulation / Constant pressure	Page
Name	Date	Draw.: Laurent	October 2018		10
		check.:			
		Norm.:			
Subject:	Compo_20190114.spl7			Application: Control MK3	of 13

TAC5 Controller

WP Cooling demand

 The SAT circuits must be plugged in before the circuit is powered. The SAT must be plugged in correctly, wrong positioning can damage both circuits permanently.

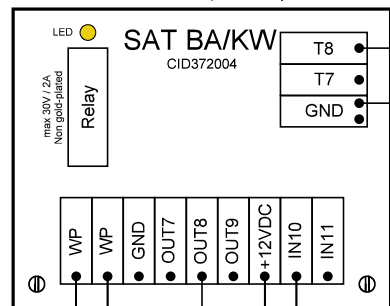

24VDC

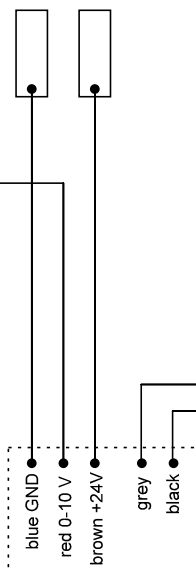

 To be insulated!

Cooling demand output

Closes on cooling load

Cooling input

Close to deactivate cooling

(Only for manual change over)

Heat/Cool selection

1=Cooling
0=Heating

(Only for manual change over)

Cooling Valve

External cooling coil
I_{max} OUT8=10mA
I_{max} OUT5=1A

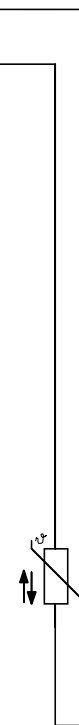

Frost sensor

Cooling coil (Surface mounted)

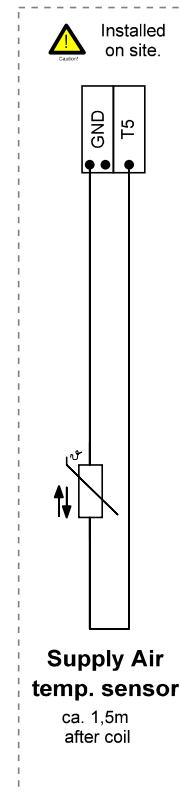

Supply Air temp. sensor

ca. 1,5m after coil

Changes			Name	Date	Configuration of function:	Page
Name	Date	Draw.:	G. Beckers	January 2019		11
		check.:			Application: Cooling coil BA-	of
Subject:	Compo_20190114.spl7		Norm:			13

TAC5 Controller

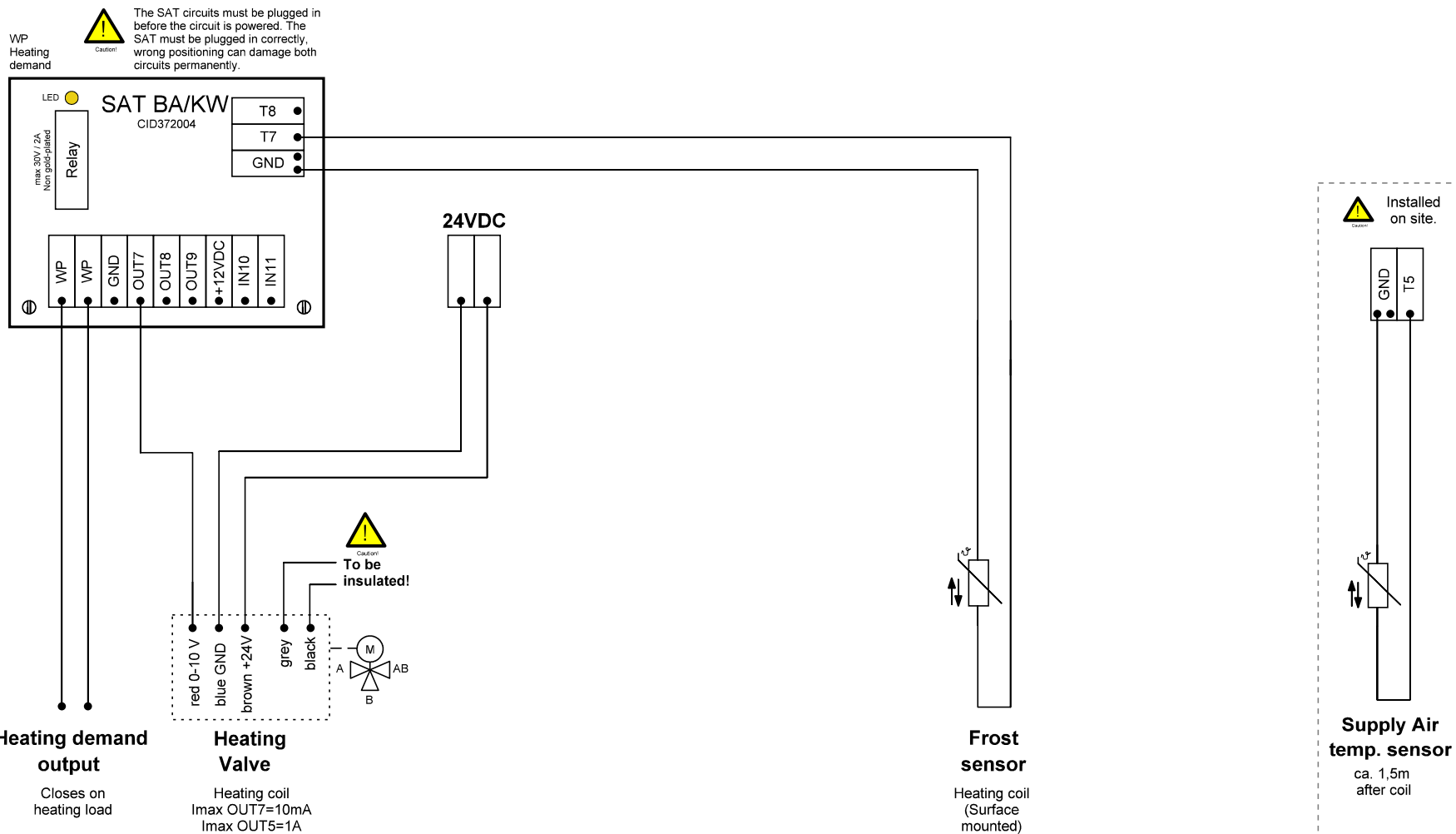

Changes		Name	Date	Configuration of function: Basic setup / Air flow regulation	Page
Name	Date	Draw.: G. Beckers	January 2019		12
		check.:			
		Norm:			
Subject:	Compo_20190114.spl7			Application: Heating Coil BA+	of 13

! The SAT circuits must be plugged in before the circuit is powered. The SAT must be plugged in correctly, wrong positioning can damage both circuits permanently.

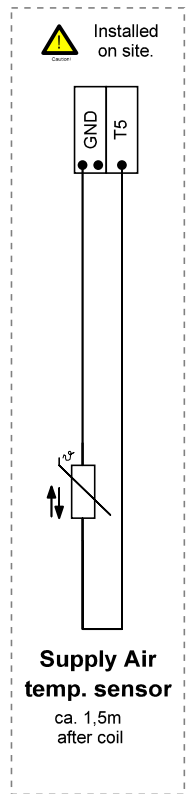
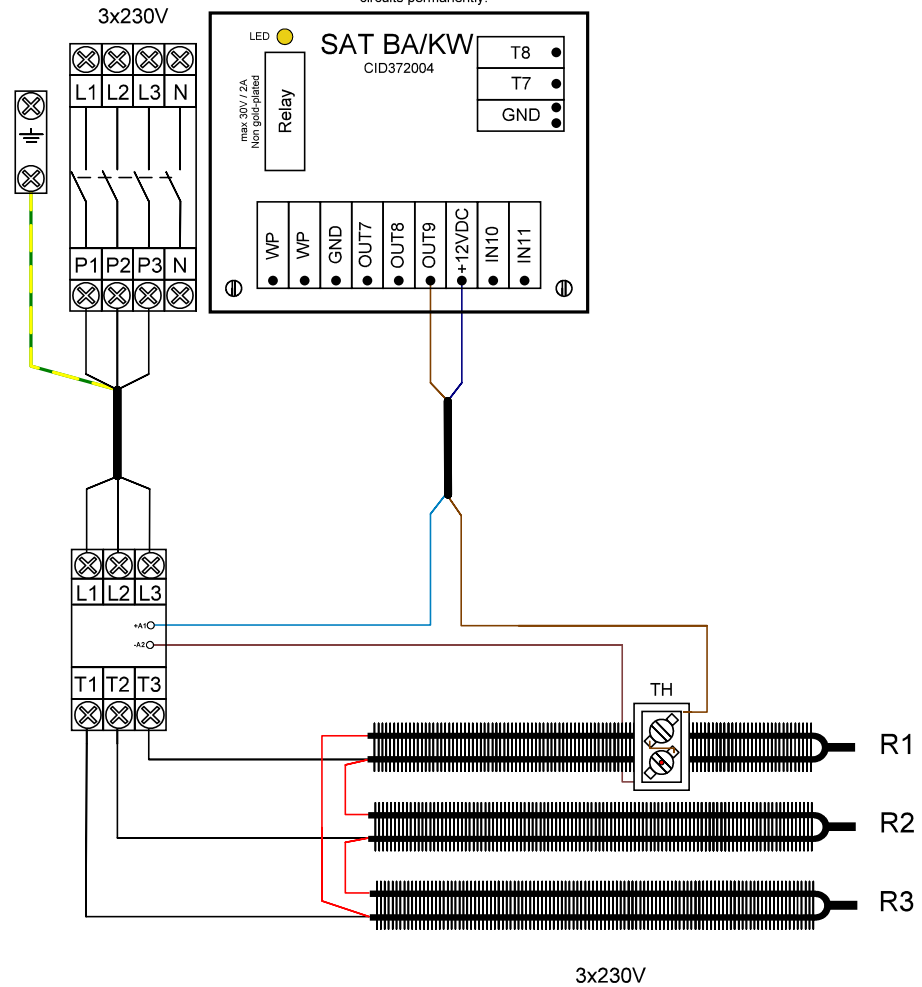
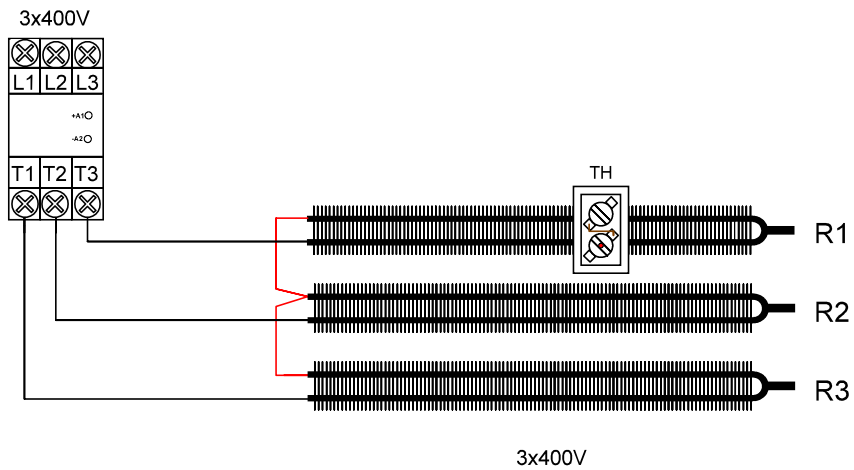

Changes			Name	Date	Configuration of function:	Page
Name	Date	Draw.:	G. Beckers	16/01/2019		
		check.:				
		Norm:			Application:	of
Subject:	Compo_20190114.spl7				Heating Coil KW	13