

# TACTouch

Operation & Assembly Manual, TAC5/TAC6 Controller

20210315









**Swegon**

# Content

<b>Safety</b> .....	3
<b>Information about documentation</b> .....	3
<b>Storage of documentation</b> .....	3
<b>Applied symbols</b> .....	3
<b>WEEE 2012/19/UE Directive</b> .....	3
<b>General information</b> .....	4
<b>Operation of the panel</b> .....	4
<b>Software update</b> .....	5
<b>Technical data</b> .....	5
<b>Exploitation conditions</b> .....	6
<b>Assembly requirements</b> .....	6
<b>The control panel installation</b> .....	6
<b>Connecting the control panel to the controller</b> .....	7
<b>Cleaning and maintenance procedures</b> .....	8
<b>Connecting TACTouch control panel to the TAC5 controller</b> .....	9

## Safety

-  Incorrect electrical connection between the control panel TACTouch and TAC5 controller may result in damage to both devices.
-  Assembly TACTouch has to be carried out by a qualified installer.
-  Use additional precautions in order to prevent the effects of controller malfunctions and software leading to loss of property and dangerous consequences.
-  Control panel TACTouch manual is a supplement for TAC5 controller documentation.
-  User should read the manual thoroughly (we bear no responsibility for damages caused by non-observance of this manual).
-  Keep this manual for future reference.

## Information about documentation



The control panel TACTouch manual is a supplement for the TAC5 controller manual. In particular, except for this manual, the controller manual should also be observed. We are not responsible for any damages caused by failure to observe these instructions.

## Storage of documentation

This assembly and operation manual, as well as any other applicable documentation, should be stored diligently, so that it was available at any time. In the case of moving or selling the device, the attached documentation should be forwarded to the new user/owner.

## Applied symbols

In this manual the following graphic symbols are used:

-  - useful information and tips.
-  - important information, failure to observe these can cause damage of property, threat for human and household animal death and life.

**Caution:** the symbols indicate important information, in order to make the manual more lucid. Yet, this does not exempt the user from the obligation to comply with requirements which are not marked with a graphic symbol.

## WEEE 2012/19/UE Directive

Purchased product is designed and made of materials of highest quality. The product meets the requirements of the **Directive 2012/19/EU of 4 July 2012 on waste electrical and electronic equipment (WEEE)**, according to which it is marked by the symbol of crossed-out wheeled bin (like below), meaning that product is subjected to separate collection.



Responsibilities after finishing a period of using product:

- dispose of the packaging and product at the end of their period of use in an appropriate recycling facility,
- do not dispose of the product with other unsorted waste,
- do not burn the product.

By adhering obligations of waste electrical and electronic equipment controlled disposal mentioned above, you avoid harmful effects on the environment and human health.

## General information

The TACTouch control panel is designed to control the TAC5 controller.

The control panel can be used in a household or similar environments and in slightly industrialized buildings.

## Operation of the panel

Device is equipped with a touchscreen.

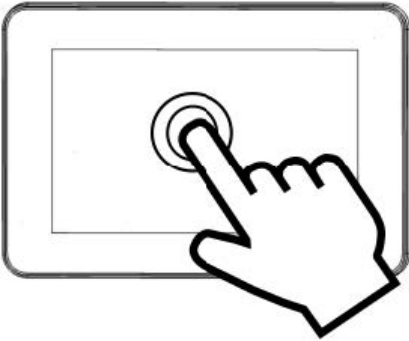

Press corresponding symbols on the screen in order to select position from the menu.

Symbols:



- scrolling and setting the parameters.



- exit a chosen menu position or cancel a parameter setting.



- quick return back to the main screen.



- menu information concerning the selected menu position.



- enter to the main menu.

## Main screen

If the heat exchanger is working, main screen shows schematics with most important values like: temperatures, speed of fans, date, actual time etc.

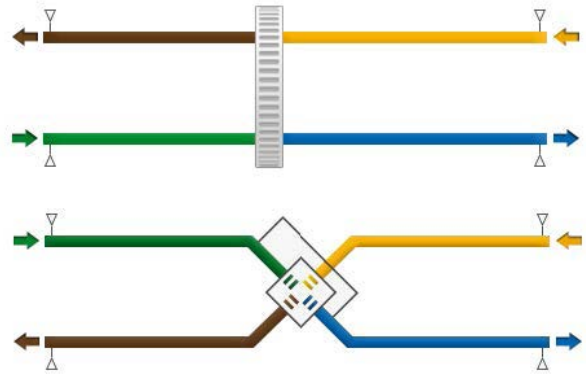

To start the controller, press anywhere on the screen with the words "Controller turned off", then appears the message "Active controller?". Confirm the message.

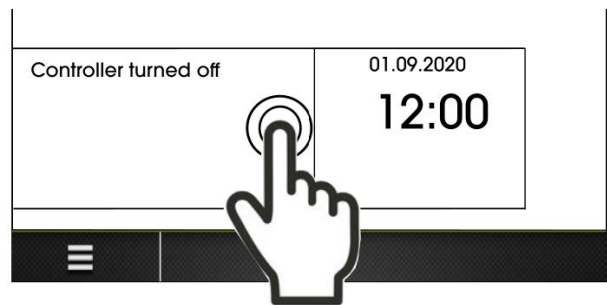

## Main menu

After pressing menu button panel shows the rotary menu.

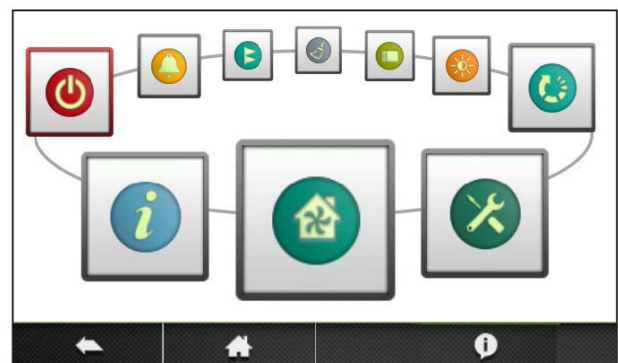

Below are examples screens with the parameters.

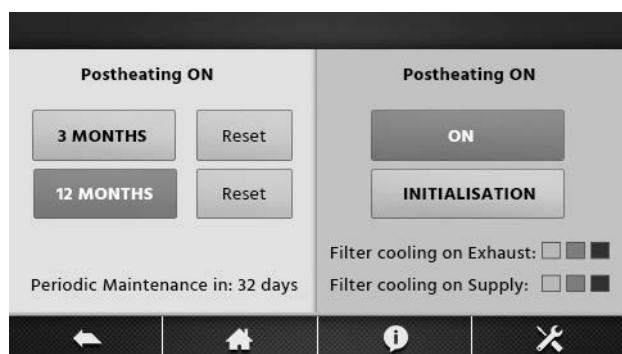
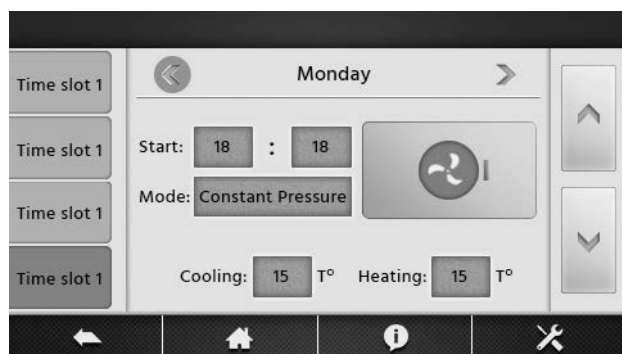
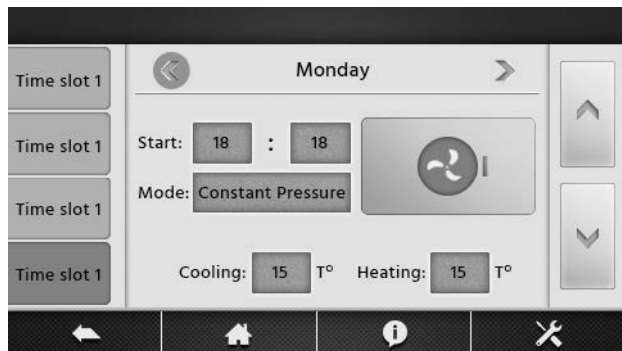
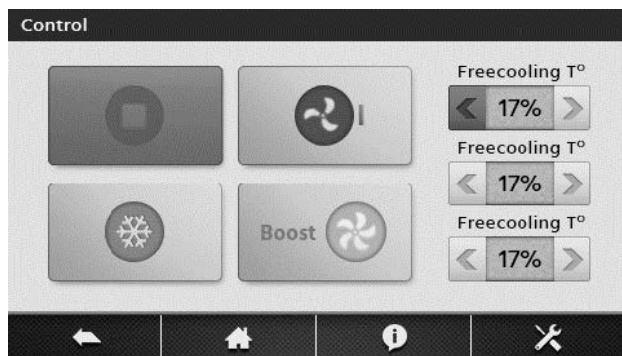

### Software update

Possibility to update the control panel software via memory card microSDHC inserted in the slot in the panel interface.

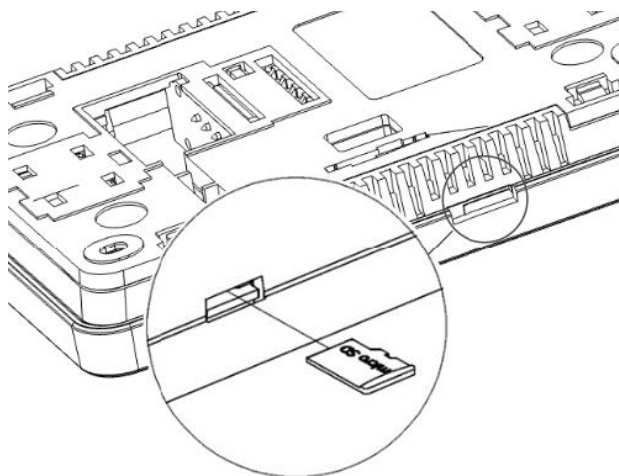

Only microSD HC type memory cards should be used (FAT32 format, max. 32 GB).

In order to replace a program, the TAC5 controller's electric power supply should be disconnected. Insert the memory card into the slot in the TACTouch panel control. The card should contain new software in a \*.pfc format. New software should be copied directly to the memory card, not to a subfolder. Connect the supply to the controller and open software update from main menu and replace the program in the TACTouch control panel.

### Technical data

Supply power	5..24 VDC - from the TAC5 controller socket
Consumed current (at 12 VDC supply voltage)	0.15 A
Protection class	IP20
Work temp. / Storage temp.	0..50°C / 0..65°C
Temperature measuring range	0...50°C
Relative humidity	5...85%, without condensation.
Display	Graphic, color 480x272 pix. with touch screen.
Dimensions	144x97x20 mm
Weight	0.2 kg
Standards	PN-EN 60730-2-9 PN-EN 60730-1
Assembly method	On wall

## Exploitation conditions

The control panel do not expose the device to direct influence of atmospheric conditions (rain, sunlight) nor vibrations stronger than typical occurring during wheel transportation. Do not use the device in vapor condensation conditions and protect it from water. Storage and transportation temperature should not exceed the range of -15...+65°C. Control panel install the device only in dry residential room.

## Assembly requirements

The control panel is designed for mounting on the wall, inside the room. The control panel should be mounted at a height allowing comfortable operation, typically 1.5 m above the floor.

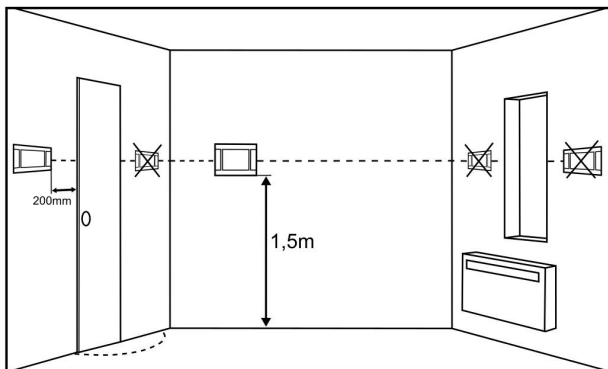

To reduce measurement disturbances avoid locations exposed to strong sunlight, with poor air circulation, near heating equipment, and directly at the door and windows (typically 0.2 m from the edge of the door).

 The control panel should be installed by a trained installer.

## The control panel installation

The control panel installation should be done according to the following guidelines.

### Assembly.

Disconnect the mounting frame (1) from the back of control panel housing (2). The frame is attached to the control panel housing with latches. Use a flat screwdriver to detach the frame.

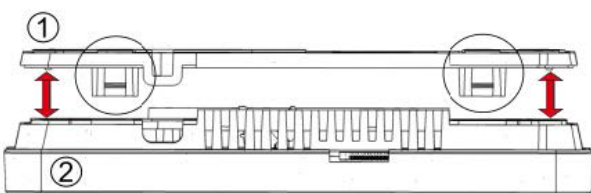

Using sharp tool cut out holes in four places of the cover (3) for the screw terminals.

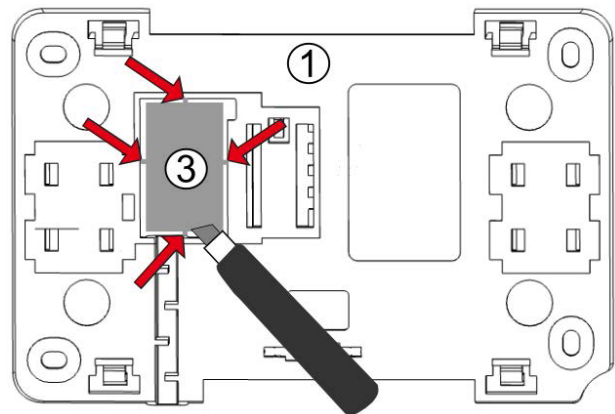

Drill holes in the wall and use screws (max. Ø 3 mm) to fix the mounting frame in the chosen place of the wall, maintaining its proper position (UP). Then attach the control panel to the mounting frame using latches.

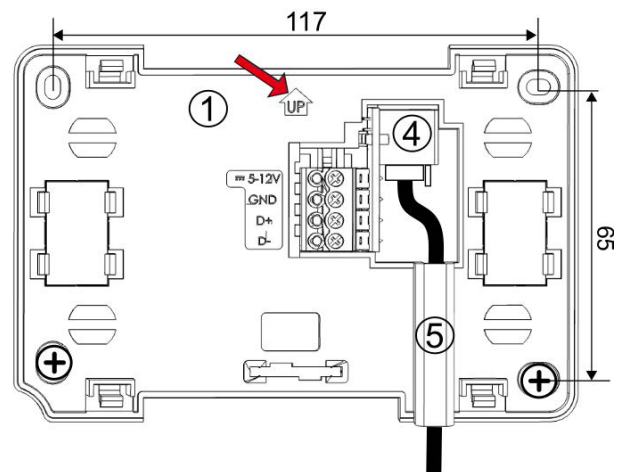

Connect the transmission cable connecting the control panel with the controller to the (4) AdaRJ adapter socket. The transmission cable can be recessed in the wall or it can run over its surface - in this case the cable should be additionally placed in the (5) cable channel. The transmission cable cannot be conducted along with the cables of the building mains. The cable should not be routed near devices emitting strong electromagnetic field. Then attach the control panel to the mounting frame using latches.

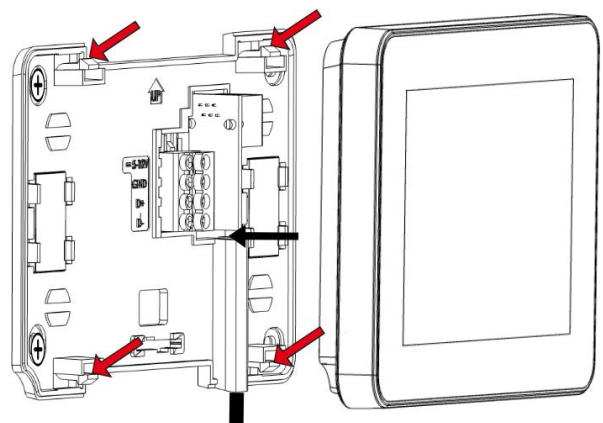

In order to place the control panel on a flat surface, a dedicated stand should be used.

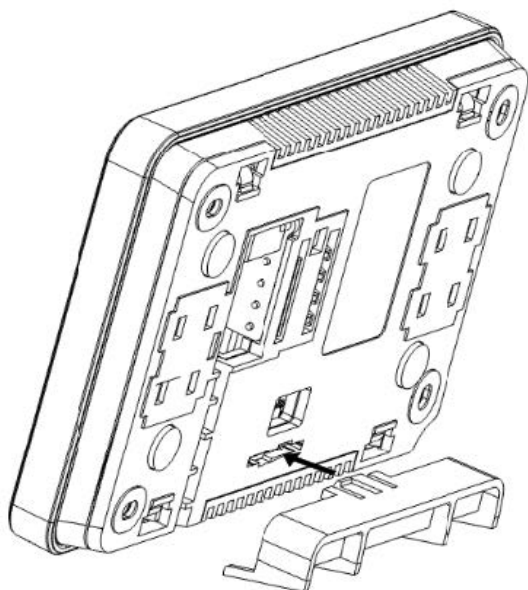

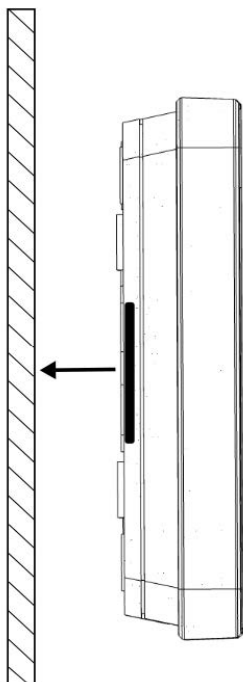

The control panel has built-in magnets, which allows it to be attached without screws to a flat metal mounting surface.



## Connecting the control panel to the controller

 The control panel should be installed with the mains supply disconnected from the controller.

 Do not mix up the poles of the cables connecting the control panel with the controller, as this may damage the control panel and the controller.

 When choosing the cable between the control panel and the controller, the rule is that the resistance of one conductor in the cable should not be greater than  $8\Omega$  and the total length of the conductor must not exceed 100 m. The longer the wire, the larger the wire cross section.

Example of cable type: YTLyp 4x0,12 mm<sup>2</sup> (about resistance 155 $\Omega$ /km), max. length of 50 m.

Signal outputs in the control panel connector:

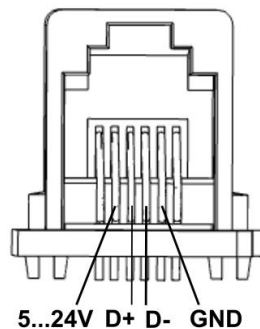

In addition, necessarily must use the EMC filter, type ZCAT1518-0730 on the cable, as shown in the figure below. The EMC filter should be included with the controller. The filter should be inserted on the cable, necessarily in the form of a cable loop between the control panel and the controller module at distance about 120 mm from the control panel connector.

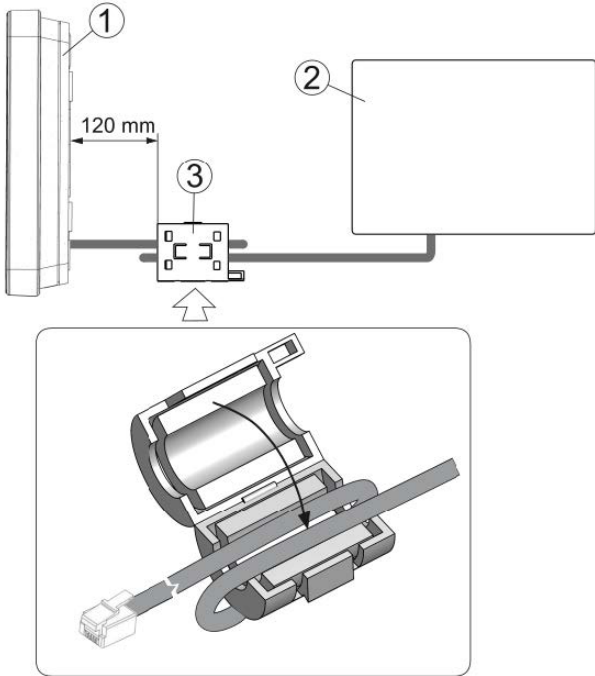

Installation EMC filter: 1 - control panel, 2 - controller module, 3 - EMC filter (type ZCAT1518-073).

In addition, EL2adapter\_v2 adapter can be used to extension the control panel connection to the controller module. The adapter provides a wire connection with an RJ-type plug with a 4-wire cable and is available from the control panel manufacturer.



## Cleaning and maintenance procedures

The outer surface and maintenance of the control panel screen.

- ⚠ The device should be cleaned with a soft, dry cloth.
- ⚠ It is not allowed to clean the device with a flammable agent or substance (i.e. benzene or any kind of solvents) or a wet cloth. Such treatment can lead to malfunction of the device.
- ⚠ It is not allowed to scratch the screen with nails or other sharp objects. It can lead to scratches or damage of the device.
- ⚠ It is not allowed to clean the device by spraying water on it. If the water gets inside of the device it can cause a fire or lead to electrocution or damage the device.





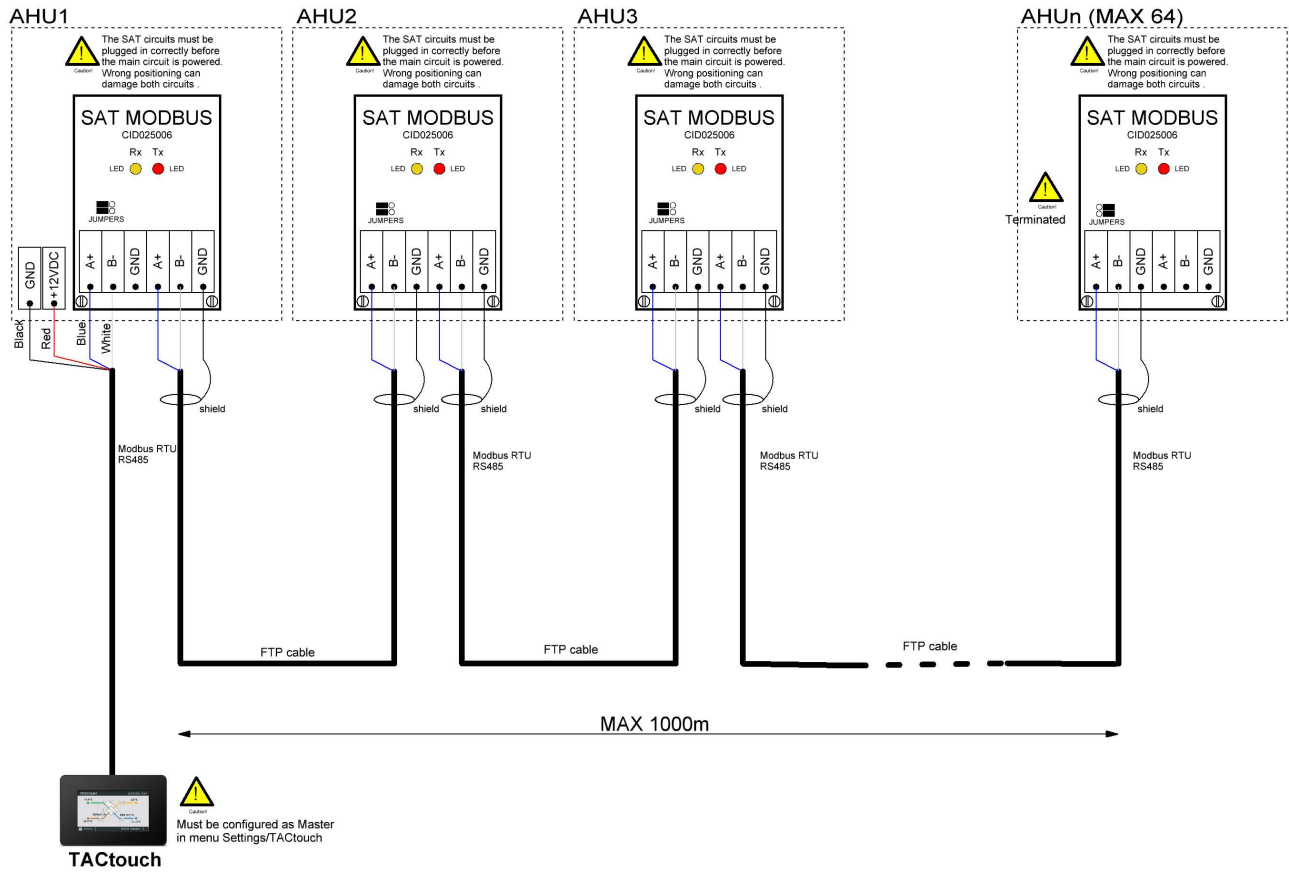

**TACTouch centralized (TAC5/TAC6).**  
**Advanced setup: configure SAT MODBUS with correct address**

<b>Open Source Software used in the product.</b>	
<b>1. zlib</b> Version 1.2.7	<p>Copyright (C) 1995-2013 Jean-loup Gailly and Mark Adler</p> <p>This software is provided 'as-is', without any express or implied warranty. In no event will the authors be held liable for any damages arising from the use of this software.</p> <p>Permission is granted to anyone to use this software for any purpose, including commercial applications, and to alter it and redistribute it freely, subject to the following restrictions:</p> <ol style="list-style-type: none"> <li>1. The origin of this software must not be misrepresented; you must not claim that you wrote the original software. If you use this software in a product, an acknowledgment in the product documentation would be appreciated but is not required.</li> <li>2. Altered source versions must be plainly marked as such, and must not be misrepresented as being the original software.</li> <li>3. This notice may not be removed or altered from any source distribution.</li> </ol> <p>Jean-loup Gailly                      Mark Adler jloup@qzip.org                      madler@alumni.caltech.edu</p>
<b>2. FatFs</b> Version 0.12b	<p>FatFs has been developed as a personal project of the author, ChaN. It is free from the code anyone else wrote at current release. Following code block shows a copy of the FatFs license document that included in the source files.</p> <pre> / FatFs - Generic FAT file system module  Rx.xx / Copyright (C) 20xx, ChaN, all right reserved. / FatFs module is an open source software. Redistribution and use of FatFs in / source and binary forms, with or without modification, are permitted provided / that the following condition is met: / / 1. Redistributions of source code must retain the above copyright notice, /   this condition and the following disclaimer. / / This software is provided by the copyright holder and contributors "AS IS" / and any warranties related to this software are DISCLAIMED. / The copyright owner or contributors be NOT LIABLE for any damages caused / by use of this software. </pre> <p>Therefore FatFs license is one of the BSD-style licenses but there is a significant feature. FatFs is mainly intended for embedded systems. In order to extend the usability for commercial products, the redistributions of FatFs in binary form, such as embedded code, binary library and any forms without source code, does not need to include about FatFs in the documentations. This is equivalent to the 1-clause BSD license. Of course FatFs is compatible with the most open source software licenses including GNU GPL. When you redistribute the FatFs source code with any changes or create a fork, the license can also be changed to GNU GPL, BSD-style license or any open source software licenses that not conflict with FatFs license.</p>
<b>3. sha2</b> Version 1.1	<p>LICENSE: This implementation is released freely under an open-source BSD license which appears at the top of each source code file.</p> <ul style="list-style-type: none"> <li>* AUTHOR: Aaron D. Gifford - <a href="http://www.aarongifford.com/">http://www.aarongifford.com/</a></li> <li>* Copyright (c) 2000-2001, Aaron D. Gifford</li> <li>* All rights reserved.</li> <li>* Redistribution and use in source and binary forms, with or without modification, are permitted provided that the following conditions are met:</li> <li>* 1. Redistributions of source code must retain the above copyright notice, this list of conditions and the following disclaimer.</li> <li>* 2. Redistributions in binary form must reproduce the above copyright notice, this list of conditions and the following disclaimer in the documentation and/or other materials provided with the distribution.</li> <li>* 3. Neither the name of the copyright holder nor the names of contributors may be used to endorse or promote products derived from this software without specific prior written permission.</li> <li>* THIS SOFTWARE IS PROVIDED BY THE AUTHOR AND CONTRIBUTOR(S) ``AS IS'' AND ANY EXPRESS OR IMPLIED WARRANTIES, INCLUDING, BUT NOT LIMITED TO, THE IMPLIED WARRANTIES OF MERCHANTABILITY AND FITNESS FOR A PARTICULAR PURPOSE ARE DISCLAIMED. IN NO EVENT SHALL THE AUTHOR OR CONTRIBUTOR(S) BE LIABLE FOR ANY DIRECT, INDIRECT, INCIDENTAL, SPECIAL, EXEMPLARY, OR CONSEQUENTIAL DAMAGES (INCLUDING, BUT NOT LIMITED TO, PROCUREMENT OF SUBSTITUTE GOODS OR SERVICES; LOSS OF USE, DATA, OR PROFITS; OR BUSINESS INTERRUPTION) HOWEVER CAUSED AND ON ANY THEORY OF LIABILITY, WHETHER IN CONTRACT, STRICT LIABILITY, OR TORT (INCLUDING NEGLIGENCE OR OTHERWISE) ARISING IN ANY WAY OUT OF THE USE OF THIS SOFTWARE, EVEN IF ADVISED OF THE POSSIBILITY OF SUCH DAMAGE.</li> </ul>



The manufacturer reserves a right for making changes in construction and software without previous notice.